



**INDUSTRIAL**

**HOSE, FITTINGS, & ACCESSORIES**





- INDEPENDENCE** RAGCO stores are independently-owned-and-operated small businesses. Our affiliates run their businesses to best suit the customers in their respective markets. They are not beholden to a national sales plan or corporate masters.
- EXPERIENCE** RAGCO stores experience remarkably low turnover thanks to great employee relations. Each store offers individuals with decades of experience in the rubber industry.
- QUALITY** Factory training. Trade organization support. Measurable results. Repeatable success. RAGCO's partners support our members with the most technologically advanced training available, and industry trade organizations such as NAHAD, NIBA, and FSA play an important role in members' systems.
- SERVICE** The forgotten aspect of today marketplace? Not at your local RAGCO location. Our customers always come first. Period.
- RESPONSIVENESS** RAGCO stores offer fast answers, quick turn-around, and prompt service after the sale.
- COMPETITIVENESS** The RAGCO group's purchasing power gives each store, large or small, highly aggressive pricing to ensure competitive solutions for their respective markets.
- FABRICATION** We offer gasket fabrication, waterjet cutting, air-knife cutting, die-press cutting, slitting, CAD, molded and moldless products, vulcanization, extrusion, and much more! RAGCO stores can customize materials per your specifications.
- NETWORKING** RAGCO members meet regularly to exchange ideas, share problems and solutions, and nurture lifelong friendships.
- RELATIONSHIPS** RAGCO holds agreements with the finest manufacturers in the world including Garlock, American Biltrite, Unaflex, Thermoseal, American Braiding, and more...
- TRADITION** Decades and decades of success in the rubber and fluid sealing industry are being reinforced by the people who make RAGCO great. Second and third generations of families continue to strive for excellence in our changing economy.



# TABLE OF CONTENTS

## RUBBER HOSE ..... 5

General Purpose Air & Water Hose .....	6	Abrasion-Resistant Corrugated SBR Suction Hose.....	19
LOR General Purpose Air & Water Hose.....	6	RAGCO Apollo™ Tank Truck Hose .....	20
MOR General Purpose Air & Water Hose.....	8	RAGCO Zeus™ UHMW Chemical Hose .....	21
Jackhammer Hose .....	9	RAGCO Poseidon™ Oilfield Suction Hose .....	22
Air Tool Hose.....	9	Hot Tar & Asphalt Hose .....	23
Push-On Hose.....	10	Food Suction Hose .....	24
Non-Conductive General Purpose Hose.....	11	Bulk-Food Suction Hose.....	24
Yellow High-Pressure General Purpose Hose.....	12	Liquid-Food Suction Hose.....	25
White Creamery Wash-Down Hose.....	13	Brewery / Winery Hose .....	26
Wire-Braided Air Hose .....	14	Steam Hose .....	27
Rubber Water-Suction Hose.....	15	Sandblast Hose.....	28
Rubber Water-Discharge Hose.....	16	Material Discharge Hose .....	29
Corrugated EPDM Suction Hose.....	18	Hot Air Blower Hose .....	30
Fuel Drop Hose.....	18	Pressure Washer Assemblies.....	30

## PLASTIC HOSE ..... 33

Green PVC Suction Hose & Assemblies.....	34	Nitrile/PVC Layflat Discharge Hose.....	40
Food-Grade Clear Suction Hose .....	35	Black.....	40
Heavy Duty Corrugated PVC Suction Hose.....	36	Yellow .....	40
Blue PVC Layflat Discharge Hose & Assemblies.....	37	Clear Braided PVC Tubing.....	41
Red PVC Layflat Discharge Hose & Assemblies .....	39	Clear PVC Tubing .....	42
		Spring Wire PVC Hose.....	43

## FIRE & MILL HOSE ..... 45

DJ Fire Hose Assemblies .....	46
DJ Mill Hose Assemblies .....	47
SJ Mill Hose (And Assemblies).....	48

## METAL HOSE ..... 51

Standard Metal Hose.....	52
High-Flexibility Metal Hose.....	54
High-Pressure Metal Hose .....	55
High Chemical-Resistance Metal Hose.....	56
Stripwound Metal Hose.....	57





## HOSE FITTINGS ..... 59

Cam & Groove Fittings .....	60	Universal Air Couplings .....	86
45- & 90-Degree Cam & Groove Fittings .....	70	Ground Joint Couplings .....	87
Cam & Groove Reducer Fittings .....	72	Male Stem Hex Hose Nipples.....	87
Cam & Groove "Y" & "T" Fittings.....	79	Sandblast Couplings .....	88
Cam & Groove X Flange .....	80	Hose Menders.....	89
Cam & Groove Accessories .....	82	Push-On Fittings.....	90
Camlock Gaskets.....	83	Brass Threaded Hose Fittings .....	91
Pin-Lug Couplings.....	84	Garden Hose Fittings.....	92
Combination Hose Nipples.....	85	Locking Lever Couplings .....	93

## QUICK DISCONNECT FITTINGS ..... 97

One-Way Shut Off.....	99	210 Series.....	120
LN Series.....	114	310 Series.....	121
SHD Series.....	115	FST Series.....	122
FRL Series .....	118	Blow Guns & Accessories .....	125

## HOSE ACCESSORIES ..... 127

Strainers.....	128	Wrenches .....	131
Foot Valves.....	129	Nozzles .....	132
Brass Ball Valves.....	129	Hydrant Adapters .....	133
Threaded Flanges.....	130	Hose Clamps.....	134
Whip Checks .....	130		

## PUMPS..... 139

RAPID Pumps .....	140
RAPID Accessories.....	147

## RESOURCES..... 149

General Information .....	150	Chemical Compatibility .....	171
Glossary of Terms.....	150	Rubber.....	171
Basic Hose Construction .....	162	Plastics.....	182
Care, Maintenance, & Storage .....	164	Metric Conversion Table .....	194
STAMPD.....	167		
Bend Radius.....	168		
Temperature/Pressure De-rating .....	169		
Oil Resistance Data.....	170		

\* RAGCO supports the autonomy of its locations to select the best products to service their markets. Subtle variations of these specifications may exist. Contact your RAGCO affiliate for confirmation.







# RUBBER HOSE





# GENERAL PURPOSE AIR & WATER HOSE

## LOR GENERAL PURPOSE AIR & WATER HOSE



Available in various colors, this general purpose air and water hose provides job/color coding possibilities for safety and other considerations. A very economical general service air and water hose, it can be used in numerous industrial, agricultural and construction applications where oil is not a factor. It is easy to handle and very flexible due to its multi-spiral layers of durable reinforcing polyester yarn. Available in a wide variety of sizes and working pressures, it has an EPDM tube and cover that resist abrasion, heat and ozone. This hose is not to be used as a steam hose.

<b>TUBE MATERIAL</b>	EPDM	<b>REINFORCEMENT</b>	Spiral polyester yarn
<b>COVER MATERIAL</b>	EPDM	<b>TEMPERATURE</b>	-40° F – 200° F
<b>COVER COLOR</b>	Red, black, green, yellow, and blue		

**INDUSTRY INTERCHANGE:** Valueflex, Frontier, GST II, AdaptaFlex, Bosflex.



# GENERAL PURPOSE AIR & WATER HOSE CONTINUED

## LOR AIR & WATER HOSE CONTINUED

NOMINAL I.D. (INCHES) (MM)		NOMINAL O.D. (INCHES) (MM)		REINFORCEMENT SPIRALS	WORKING PRESSURE (PSI)	MIN. BEND RADIUS (INCHES) (MM)		WEIGHT (LB/FT) (KG/M)	
3/16	4.76	0.44	11.11	2	200	N/A	N/A	0.08	0.12
1/4	6.35	0.49	12.45	2	150	1.50	38.10	0.08	0.12
1/4	6.35	0.49	12.45	2	200	1.50	38.10	0.08	0.12
1/4	6.35	0.50	14.22	2	250	1.50	38.10	0.08	0.12
1/4	6.35	0.50	15.75	2	300	1.50	38.10	0.08	0.12
5/16	7.94	0.58	14.73	2	200	2.00	50.80	0.09	0.13
5/16	7.94	0.58	15.75	2	300	2.00	50.80	0.09	0.13
3/8	9.53	0.69	17.53	2	150	2.25	57.15	0.15	0.22
3/8	9.53	0.69	17.53	2	200	2.25	57.15	0.15	0.22
3/8	9.53	0.69	17.53	2	250	2.25	57.15	0.15	0.22
3/8	9.53	0.69	17.53	2	300	2.25	57.15	0.15	0.22
1/2	12.70	0.81	20.64	2	150	3.00	76.20	0.20	0.30
1/2	12.70	0.81	20.64	4	200	3.00	76.20	0.25	0.37
1/2	12.70	0.84	21.43	4	250	3.00	76.20	0.25	0.37
1/2	12.70	0.84	21.43	4	300	3.00	76.20	0.25	0.37
5/8	15.88	0.93	23.62	4	150	3.75	95.25	0.24	0.36
5/8	15.88	0.93	23.62	4	200	3.75	95.25	0.30	0.45
5/8	15.88	1.00	25.40	4	250	3.75	95.25	0.30	0.45
5/8	15.88	1.00	25.40	4	300	3.75	95.25	0.30	0.45
3/4	19.05	1.12	28.45	4	150	4.50	114.30	0.34	0.51
3/4	19.05	1.15	29.21	4	200	4.50	114.30	0.38	0.57
3/4	19.05	1.15	29.21	4	250	4.50	114.30	0.38	0.57
3/4	19.05	1.15	29.21	4	300	4.50	114.30	0.41	0.61
1	25.40	1.37	34.80	4	150	7.00	177.80	0.43	0.64
1	25.40	1.37	34.80	4	200	7.00	177.80	0.51	0.76
1	25.40	1.43	36.20	4	300	7.00	177.80	0.51	0.76
1-1/4	31.75	1.75	44.45	4	200	8.75	222.25	0.81	1.21
1-1/2	38.10	2.00	50.80	4	200	10.50	266.70	0.89	1.34
2	50.80	2.55	64.77	4	200	14.00	355.60	1.28	1.90

\* RAGCO supports the autonomy of its locations to select the best products to service their markets. Subtle variations of these specifications may exist. Contact your RAGCO affiliate for confirmation.





# GENERAL PURPOSE AIR & WATER HOSE CONTINUED

## MOR GENERAL PURPOSE AIR & WATER HOSE



This air and multi-purpose hose is designed to handle the oily mists used to lubricate pneumatic tools. Featuring a medium oil-resistant tube with multi-spiral polyester reinforcement, the hose remains flexible even in extreme temperatures. Its durable cover resists abrasion, cracking, weathering and ozone. Not recommended for handling fuels.

<b>COVER COLOR</b>	Red	<b>OIL RESISTANCE</b>	Medium
<b>TUBE MATERIAL</b>	EPDM, RMA Class C	<b>COVER MATERIAL</b>	EPDM
<b>REINFORCEMENT</b>	Spiral polyester yarn	<b>TEMPERATURE RANGE</b>	-40°F to +200°F

NOMINAL I.D. (INCHES) (MM)		NOMINAL O.D. (INCHES) (MM)		REINFORCEMENT SPIRALS	WORKING PRESSURE (PSI)	MIN. BEND RADIUS (INCHES) (MM)		WEIGHT (LB/FT) (KG/M)	
1/4	6.35	0.50	12.70	2	200	1.50	38.10	0.09	0.13
1/4	6.35	0.50	12.70	2	300	1.50	38.10	0.15	0.22
5/16	7.94	0.62	15.75	4	300	2.00	50.80	0.14	0.21
3/8	9.53	0.69	17.53	2	200	2.25	57.15	0.15	0.22
3/8	9.53	0.69	17.53	2	300	2.25	57.15	0.18	0.27
1/2	12.70	0.81	20.64	2	200	3.00	76.20	0.19	0.28
1/2	12.70	0.84	21.34	4	300	3.00	76.20	0.25	0.37
5/8	15.88	1.00	25.40	4	300	3.75	95.25	0.30	0.45
3/4	19.05	1.15	29.21	4	250	4.50	114.30	0.37	0.55
3/4	19.05	1.15	29.21	4	250	4.50	114.30	0.37	0.55
3/4	19.05	1.15	29.21	4	300	4.50	114.30	0.37	0.55
3/4	19.05	1.15	29.21	4	300	4.50	114.30	0.37	0.55
1	25.40	1.37	34.80	4	200	7.00	177.80	0.42	0.62
1	25.40	1.43	36.20	4	300	7.00	177.80	0.50	0.74
1-1/4	31.75	1.75	44.45	4	200	8.75	222.25	0.81	1.21
1-1/2	38.10	2.00	50.80	4	200	10.50	266.70	0.94	1.40
2	50.80	2.55	64.77	4	200	14.00	355.60	1.12	1.67

INDUSTRY INTERCHANGE: Mainliner, Ortac, Super-Flex GS





## JACKHAMMER HOSE

Rugged four-spiral, with various psi construction, these assemblies can tackle the job that only a jackhammer can dish out. The EPDM tube and cover handle heat, ozone and weather cracking better than other compounds. These hoses are assembled at the factory, crimped with universal (Chicago, CP) fittings at each end. Durability is built in and this hose is ready for hard work. Also available in yellow.



<b>COVER COLOR</b>	Red (also available in yellow)	<b>OIL RESISTANCE</b>	Limited
<b>TUBE MATERIAL</b>	EPDM	<b>COVER MATERIAL</b>	EPDM
<b>REINFORCEMENT</b>	Spiral polyester yarn	<b>TEMPERATURE RANGE</b>	-40°F to +200°F

NOMINAL I.D. (INCHES) (MM)		NOMINAL O.D. (INCHES) (MM)		REINFORCEMENT SPIRALS	WORKING PRESSURE (PSI)	MIN. BEND RADIUS (INCHES) (MM)		WEIGHT (LB/FT) (KG/M)	
3/4	19.05	1.15	29.21	4	200	4.50	114.30	0.38	0.57
3/4	19.05	1.15	29.21	4	250	4.50	114.30	0.38	0.57
3/4	19.05	1.15	29.21	4	300	4.50	114.30	0.41	0.61
1	25.40	1.37	34.80	4	200	7	177.80	0.51	0.76

**INDUSTRY INTERCHANGE:** Air Power, Sledgehammer

## AIR TOOL HOSE

This lightweight utility-grade air hose is economically designed for indoor and outdoor applications operating in temperate climate conditions. Pre-assembled in 50-foot sections and coupled with brass 1/4" male pipe thread fitting on each end. Mostly assembled with rubber or PVC hose. Custom lengths available.



<b>TUBE MATERIAL</b>	EPDM or PVC	<b>FITTINGS</b>	Brass 1/4" MPT both ends
<b>COVER MATERIAL</b>	EPDM or PVC	<b>STANDARD LENGTH</b>	50ft
<b>REINFORCEMENT</b>	Spiral polyester yarn	<b>TEMPERATURE RANGE</b>	14°F to +150°F

\* RAGCO supports the autonomy of its locations to select the best products to service their markets. Subtle variations of these specifications may exist. Contact your RAGCO affiliate for confirmation.



# GENERAL PURPOSE AIR & WATER HOSE CONTINUED

## PUSH-ON HOSE



Designed specifically for use with robotic welders and industrial applications requiring an MSHA-approved flame-resistant cover, Push-On Hose is a premium 300 psi, oil-resistant, non-conductive push-on hose that provides safe and reliable performance in oily and harsh conditions. It features an excellent coupling retention and a superior hold created by a unique spiral angle design and polyester reinforcement that firmly grips the fitting and will not give under pressure.

<b>TUBE MATERIAL</b>	Nitrile, RMA Class A	<b>REINFORCEMENT</b>	Spiral polyester
<b>COVER MATERIAL</b>	Nitrile/PVC RMA Class A	<b>TEMPERATURE</b>	-30°F to +180°F
<b>OIL RESISTANCE</b>	High	<b>CONSTRUCTION</b>	Non-conductive
<b>COVER COLORS</b>	Black, blue, gray, red, green or yellow		

COLOR	NOMINAL I.D.		NOMINAL O.D.		REINFORCEMENT SPIRALS	WORKING PRESSURE (PSI)	MIN. BEND RADIUS		WEIGHT	
	(INCHES)	(MM)	(INCHES)	(MM)			(INCHES)	(MM)	(LB/FT)	(KG/M)
Black	1/4	6.35	0.50	12.70	2	300	1.50	38.10	0.10	0.15
	3/8	9.53	0.63	15.88	2	300	2.25	57.15	0.13	0.19
	1/2	12.70	0.75	19.05	2	300	3.00	76.20	0.16	0.24
	5/8	15.88	0.91	23.02	2	300	3.75	95.25	0.23	0.34
	3/4	19.05	1.03	26.19	2	300	4.50	114.30	0.26	0.39
Blue	1/4	6.35	0.50	12.70	2	300	1.50	38.10	0.10	0.15
	3/8	9.53	0.63	15.88	2	300	2.25	57.15	0.13	0.19
	1/2	12.70	0.75	19.05	2	300	3.00	76.20	0.16	0.24
Gray	1/4	6.35	0.50	12.70	2	300	1.50	38.10	0.10	0.15
	3/8	9.53	0.63	15.88	2	300	2.25	57.15	0.13	0.19
	1/2	12.70	0.75	19.05	2	300	3.00	76.20	0.16	0.24
Red	1/4	6.35	0.50	12.70	2	300	1.50	38.10	0.10	0.15
	3/8	9.53	0.63	15.88	2	300	2.25	57.15	0.13	0.19
	1/2	12.70	0.75	19.05	2	300	3.00	76.20	0.16	0.24
Green	1/4	6.35	0.50	12.70	2	300	1.50	38.10	0.10	0.15
	3/8	9.53	0.63	15.88	2	300	2.25	57.15	0.13	0.19
	1/2	12.70	0.75	19.05	2	300	3.00	76.20	0.16	0.24
Yellow	3/8	9.53	0.63	15.88	2	300	2.25	57.15	0.13	0.19

INDUSTRY INTERCHANGE: Flex-Loc, InstaGrip, Super-Lok GS





## NON-CONDUCTIVE GENERAL PURPOSE HOSE

This hose is designed to stand up to the tough working conditions found in shipyards, steel processing automotive plants and construction industries, as well as aluminum reduction and other applications where a high degree of electrical non-conductivity is required. Its spiral, polyester, reinforcing cords provide strength and flexibility even in extreme temperatures, and its NBR tube and synthetic cover can convey oil, diesel, kerosene, fuel oil and other petroleum-based products while resisting oil, solvents, cracking, abrasion and ozone. It provides a constant pressure of either 250 or 300 psi, 1/4" through the 1-1/2" sizes. Not recommended for a variety of unleaded gasoline types.



<b>TUBE MATERIAL</b>	Nitrile, RMA Class A	<b>REINFORCEMENT</b>	Spiral polyester
<b>COVER MATERIAL</b>	Red. Nitrile/PVC RMA Class A.	<b>TEMPERATURE</b>	-30°F to +180°F
<b>OIL RESISTANCE</b>	High	<b>CONSTRUCTION</b>	Non-conductive

NOMINAL I.D. (INCHES) (MM)		NOMINAL O.D. (INCHES) (MM)		REINFORCEMENT SPIRALS	WORKING PRESSURE (PSI)	MIN. BEND RADIUS (INCHES) (MM)		WEIGHT (LB/FT) (KG/M)	
1/4	6.35	0.62	15.75			4	300	1.50	38.10
3/8	9.53	0.69	17.53	4	300	2.25	57.15	0.18	0.27
1/2	12.70	0.84	21.34	4	300	3.00	76.20	0.25	0.37
3/4	19.05	1.15	29.21	4	300	4.50	114.30	0.42	0.62
1	25.40	1.43	36.20	4	300	7.00	177.80	0.63	0.94
1-1/4	31.75	1.78	45.24	4	250	8.75	222.25	0.81	1.21
1-1/2	38.10	2.03	51.59	4	250	10.50	266.70	0.95	1.41

**INDUSTRY INTERCHANGE:** Versicon, Super MPT II

\* RAGCO supports the autonomy of its locations to select the best products to service their markets. Subtle variations of these specifications may exist. Contact your RAGCO affiliate for confirmation.



## HEAVY-DUTY YELLOW MULTI-PURPOSE



A highly versatile, multi-purpose hose designed for high pressure applications and extreme temperature environments ranging from -40°F to +212°F. It is ideal for use in rock-drilling, air-hammer and water-jetting applications in heavy construction, mining or quarry operations, as well as the transfer of petroleum or other solvent solutions, and washer operations. This hose is non-conductive and MSHA-approved with a Class A RMA rating, providing a constant 1,000 psi working pressure, with a minimum 4:1 burst safety factor.

<b>COVER MATERIAL</b>	Yellow; XNBR, RMA Class A (Pin Pricked)	<b>OIL RESISTANCE</b>	High
<b>TUBE MATERIAL</b>	NBR, RMA Class A	<b>TEMPERATURE RANGE</b>	-40°F to +212°F
<b>REINFORCEMENT</b>	4-spiral aramid fiber – 3/4" and 1" sizes      4-spiral polyester yarn –1/4", 3/8", 1/2" sizes		

NOMINAL I.D. (INCHES) (MM)		NOMINAL O.D. (INCHES) (MM)		REINFORCEMENT SPIRALS	WORKING PRESSURE (PSI)	MIN. BEND RADIUS (INCHES) (MM)		WEIGHT (LB/FT) (KG/M)	
1/4	6.35	0.63	15.88	4	1000	1.50	38.10	0.16	0.24
3/8	9.53	0.75	19.05	4	1000	2.25	57.15	0.22	0.33
1/2	12.70	0.94	23.81	4	1000	3.00	76.20	0.24	0.36
3/4	19.05	1.13	28.58	4	1000	4.50	114.30	0.35	0.52
1	25.40	1.50	38.10	4	1000	7.00	177.80	0.47	0.70

**INDUSTRY INTERCHANGE:** Hercules, Fortress



## WHITE WASH-DOWN

This white wash-down hose or "creamery hose" is designed for wash-down service in creameries, dairies, packing houses, canneries and food processing plants. It features an EPDM tube and cover that resist scuffing and cracking, and is color-coded white to indicate wash-down service and cleanliness. This hose handles hot water up to 200°F at 50 psi, and is rated for working pressures up to 250 psi on 1/2" I.D.



<b>COVER COLOR</b>	White	<b>OIL RESISTANCE</b>	High
<b>COVER MATERIAL</b>	EPDM	<b>TEMPERATURE RANGE</b>	-40°F to +180°F
<b>TUBE MATERIAL</b>	EPDM	<b>REINFORCEMENT</b>	Spiral polyester yarn

NOMINAL I.D. (INCHES) (MM)		NOMINAL O.D. (INCHES) (MM)		REINFORCEMENT SPIRALS	WORKING PRESSURE (PSI)	MIN. BEND RADIUS (INCHES) (MM)		WEIGHT (LB/FT) (KG/M)	
1/2	12.70	0.91	23.02	4	250	3.00	76.20	0.29	0.43
3/4	19.05	1.25	31.75	4	200	4.50	114.30	0.50	0.74

**INDUSTRY INTERCHANGE:** Dari-Preen, Sani-Wash



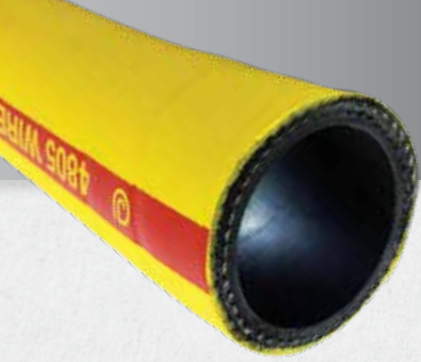

# WIRE-BRAIDED AIR HOSE

For heavy-duty air supply in mining, quarries, construction, industrial air placement, sandblasting and heavy-duty equipment rental. Oil mist-resistant tube with high working pressure. Cover is bright yellow and heavy duty for great durability.

<b>CONSTRUCTION</b>	Tube is nitrile blend, smooth and black	<b>TEMPERATURE</b>	-25°F (-32°C) to +200°F (+93°C)
<b>COVER</b>	SBR, yellow, fabric impression and pin-pricked	<b>REINFORCEMENT</b>	2 spiral wires

ID	OD	WP (PSI)	MIN BEND RADIUS	WEIGHT/FT (LBS)
1/2"	0.91"	600	5.5"	0.36
3/4"	1.22"	600	8.3"	0.6
1"	1.49"	600	11"	0.8
1-1/4"	1.81"	600	13.8"	1.05
1-1/2"	2.04"	600	16.5"	1.24
2"	2.60"	600	22"	1.8
2-1/2"	3.15"	600	27.5"	2.4
3"	3.70"	600	33.1"	3.22
4"	4.88"	600	44.1"	4.7
6"	6.89"	600	63"	6.82

**INDUSTRY INTERCHANGE:** Ultrabraid, Thoro-Braid, Air Drill, Contractor's Air



# RUBBER WATER-SUCTION HOSE



A flexible and economical hose for suction, discharge, or gravity flow of water in construction, mining, oil exploration, agriculture and equipment rental. Resistant to water-based AG fertilizers and salt water. Cover is abrasion- and weather-resistant.

<b>CONSTRUCTION</b>	Tube is EPDM blend, smooth and black	<b>TEMPERATURE</b>	-25°F (-32°C) to +185°F (+85°C)
<b>COVER</b>	EPDM blend with a fabric impression	<b>REINFORCEMENT</b>	2-ply or 4-ply synthetic fabric with a double wire helix

ID	OD	WP (PSI)	VACUUM (HG)	MIN BEND RADIUS	WEIGHT/FT (LBS)
1"	1.42"	150	Full	3.75"	0.5
1-1/4"	1.7"	150	Full	6"	0.75
1-1/2"	1.96"	150	Full	6.5"	0.8
2"	2.49"	150	Full	8"	1.11
2-1/2"	2.99"	150	Full	10"	1.75
3"	3.5"	150	Full	12"	2.24
4"	4.53"	150	Full	18"	2.79
5"	5.68"	150	Full	26"	3.25
6"	6.54"	150	Full	31"	5.75
8"	8.79"	150	Full	42"	6.59
10"	10.91"	75	Full	50"	10.25
12"	12.91"	75	25	60"	13.5
14"	15.13"	75	25	72"	16.75

**INDUSTRY INTERCHANGE:** Transporter, Con-Ag, Day-Flo 7257, Barracuda, Otter

\* RAGCO supports the autonomy of its locations to select the best products to service their markets. Subtle variations of these specifications may exist. Contact your RAGCO affiliate for confirmation.





# TWO-PLY WATER DISCHARGE HOSE

For medium-duty discharge of water in construction, mining, oil exploration, agriculture, equipment rental, and more. Can be crimped or banded to make assemblies per your specifications.

<b>COVER MATERIAL</b>	Wrapped EPDM blend	<b>REINFORCEMENT</b>	Two-ply, high-tensile fiber cord plies
<b>TUBE MATERIAL</b>	EPDM or EPDM blend	<b>TEMPERATURE RANGE</b>	-40° F to 185° F

I.D.	O.D.	REIN. PLIES	MAX. W.P. AT 68°F	MIN. BEND RADIUS	WEIGHT
1 1/2 in	1.81 in	2	150 psi	15.00 in	0.60 lb/ft
2 in	2.31 in	2	150 psi	20.00 in	0.84 lb/ft
2 1/2 in	2.75 in	2	150 psi	25.00 in	0.91 lb/ft
3 in	3.38 in	2	150 psi	30.00 in	1.12 lb/ft
4 in	4.37 in	2	150 psi	40.00 in	1.25 lb/ft
5 in	5.51 in	2	150 psi	50.00 in	2.29 lb/ft
6 in	6.50 in	2	150 psi	60.00 in	3.45 lb/ft
8 in	8.50 in	2	100 psi	80.00 in	4.30 lb/ft
10 in	10.50 in	2	100 psi	100.00 in	5.40 lb/ft
12 in	12.50 in	2	100 psi	120.00 in	6.75 lb/ft

**INDUSTRY INTERCHANGE:** WD-150, Plicord, Day-Flo 7306, Steelhead, Leader



# FOUR-PLY WATER DISCHARGE HOSE

For heavy-duty discharge of water in construction, mining, oil exploration, agriculture, equipment rental, in-plant service and more. Can be crimped or banded to make assemblies per your specifications.

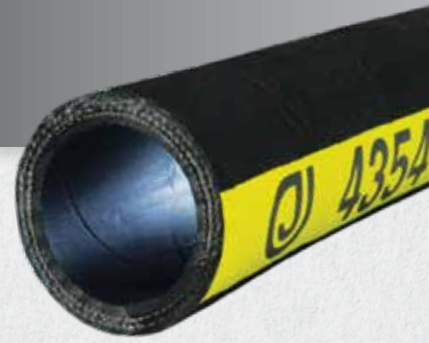

<b>COVER MATERIAL</b>	Wrapped EPDM blend	<b>REINFORCEMENT</b>	Four-ply, high-tensile fiber cord plies
<b>TUBE MATERIAL</b>	EPDM or EPDM blend	<b>TEMPERATURE RANGE</b>	-40° F to 185° F

I.D.	O.D.	REIN. PLYS	MAX. W.P. AT 68°F	MIN. BEND RADIUS	WEIGHT
1 1/2 in	2.00 in	4	250 psi	15.00 in	0.83 lb/ft
2 in	2.56 in	4	250 psi	20.00 in	1.11 lb/ft
2 1/2 in	3.07 in	4	250 psi	25.00 in	1.24 lb/ft
3 in	3.58 in	4	225 psi	30.00 in	1.50 lb/ft
4 in	4.61 in	4	200 psi	40.00 in	1.85 lb/ft
6 in	6.57 in	4	150 psi	60.00 in	3.90 lb/ft
8 in	8.66 in	4	125 psi	80.00 in	5.25 lb/ft
10 in	10.66 in	4	125 psi	100.00 in	6.29 lb/ft
12 in	12.68 in	4	125 psi	120.00 in	7.83 lb/ft

**INDUSTRY INTERCHANGE:** Plicord HD, SS110

\* RAGCO supports the autonomy of its locations to select the best products to service their markets. Subtle variations of these specifications may exist. Contact your RAGCO affiliate for confirmation.





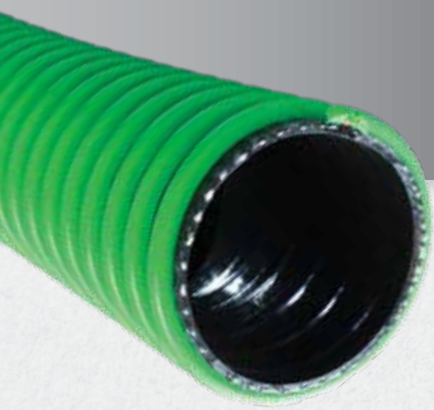

# CORRUGATED EPDM SUCTION HOSE

This lightweight, flexible, and durable hose makes for easy handling in irrigation lines, septic service, trash pumps, marine, and irrigation applications. Known as Tigerflex Green or Series 2000. Can be crimped or banded to make assemblies per your specifications.

<b>CONSTRUCTION</b>	EPDM tube w/ polyethylene helix	<b>TEMPERATURE RANGE</b>	-40° F to 160° F
---------------------	---------------------------------	--------------------------	------------------

I.D.	O.D.	APPROX W.P. @ 140° F (PSI)	APPROX BURST PRESSURE @ 72° F (PSI)	VACUUM RATING (IN/HG)	REC MIN BEND RADIUS @ 72° F (INCH)	APPROX WEIGHT (LBS/FT)
1"	1.34"	80	240	28	4	0.23
1 1/4"	1.61"	70	210	28	5	0.3
1 1/2"	1.96"	60	180	28	6	0.49
2"	2.49"	60	180	28	9	0.69
2 1/2"	3"	50	150	28	11	0.91
3"	3.6"	50	150	28	12	1.205
4"	4.69"	45	135	28	17	1.83
6"	6.86"	35	105	20	17	3.84

**INDUSTRY INTERCHANGE:** Tiger-Green, Series 2000, Masterflex 300, 300EPDM



# FUEL DROP HOSE

Tank-truck gravity drop hose for such items as gasoline, naphtha, kerosene, light and heavy oil, diesel, and up to 15% ethanol mixture. Not for biodiesel.

<b>CONSTRUCTION</b>	Nitrile rubber, rigid PVC helix, synthetic braiding, smooth bore, static grounding wire, corrugated O.D.
<b>TEMPERATURE</b>	-30°F to 140°F

I.D.	O.D.	PITCH	WORKING PRESSURE (PSI)	MIN. BEND RADIUS	VACUUM RATING (IN/HG)	WEIGHT/FT (LBS)
2"	2.68"	.39"	65	5"	29.8	1.13
3"	3.68"	.59"	65	6"	29.8	1.37
4"	4.82"	.65"	65	8"	29.8	2.16

**INDUSTRY INTERCHANGE:** Paladin, SP204, 120LT, Spiralite 5000-00





# ABRASION-RESISTANT CORRUGATED SBR SUCTION HOSE

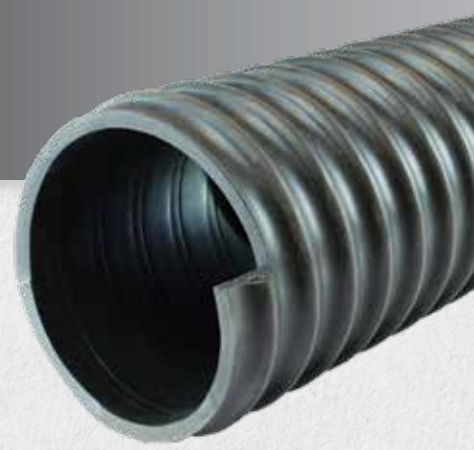

Abrasive suction for crushed rock, sand, dry fertilizer, small gravel and powdered cement. Can also be used as a boom hose for catch basin clean-out. Lightweight, heavy-duty abrasion resistance, -40°F cold-weather resistance, sub-zero flexibility, and a ground wire is not needed as the tube-and-cover compound are static-dissipating.

<b>CONSTRUCTION</b>	Abrasion-resistant SBR tube and cover that are both static-dissipating with a sturdy clockwise helix
<b>TEMPERATURE RANGE</b>	-40° F to 160° F

I.D.	O.D.	WORKING PRESSURE (PSI)	MINIMUM BEND RADIUS	VACUUM (IN/HG)	WEIGHT/FT (LBS)
1 ½"	1.82"	45	2"	29	.37
2"	2.35"	40	2.5"	29	.50
2 ½"	2.95"	35	2.5"	29	.88
3"	3.51"	35	3"	29	1.1
4"	4.63"	30	4.5"	29	1.76
5"	5.75"	30	5"	28	2.47
6"	6.73"	30	9"	28	3.09
8"	9.04"	30	15"	27	5.65

\* RAGCO supports the autonomy of its locations to select the best products to service their markets. Subtle variations of these specifications may exist. Contact your RAGCO affiliate for confirmation.



# RAGCO APOLLO™ TANK TRUCK HOSE



RAGCO Apollo Tank Truck Hose is a top-of-the-line product for use in tank truck and in-plant operations to transfer gasoline, oil, ethanol blends and other petroleum-base products up to 50% aromatic content. It is designed for pressure, gravity flow, or full-suction service.

<b>CONSTRUCTION TUBE</b>	Nitrile synthetic rubber RMA Class A (High Oil Resistance)		
<b>COVER MATERIAL</b>	Black (red stripe), petroleum, resistant, synthetic rubber smooth cover; wrapped finish		
<b>REINFORCEMENT</b>	Spiral-plyed synthetic fabric with wire helix	<b>TEMPERATURE RANGE</b>	-35 °F to 200 °F (-37 °C to 93 °C)

NOMINAL I.D. (INCHES) (MM)		NOMINAL O.D. (INCHES) (MM)		WORKING PRESSURE (PSI) (MPA)		VACUUM (IN/HG)	MIN. BEND RADIUS (INCHES) (MM)		WEIGHT (LB/FT) (KG/M)	
3/4	19.1	1.22	31	150	1.03	29	2	51	0.47	0.7
1	25.4	1.5	38.1	150	1.03	29	2	51	0.63	0.94
1 1/4	31.8	1.76	44.7	150	1.03	29	3	76	0.79	1.18
1 1/2	38.1	2.03	51.6	150	1.03	29	4	102	0.99	1.47
2	50.8	2.55	64.8	150	1.03	29	5	114	1.3	1.93
2 1/2	63.5	3.07	78	150	1.03	29	6	146	1.66	2.47
3	76.2	3.57	90.7	150	1.03	29	7	178	2.03	3.02
4	101.6	4.6	116.8	150	1.03	29	10	254	2.68	3.99
6	152.7	6.78	171.9	150	1.03	29	30	762	5.61	8.36

**INDUSTRY INTERCHANGE:** Flexwing, Transporter Black, Translite, Longhorn, Puma



# RAGCO ZEUS™ UHMWPE CHEMICAL HOSE



RAGCO Zeus UHMWPE Chemical Hose is a high-end industrial hose for the transfer of corrosive fluids and solvents in suction or discharge applications. It handles the majority of common industrial chemicals.

<b>CONSTRUCTION TUBE</b>	Ultra-High Molecular Weight Polyethylene (UHMWPE)	
<b>COVER MATERIAL</b>	Corrugated, abrasion-resistant, synthetic rubber. Usually blue or green.	
<b>REINFORCEMENT</b>	Spiral-plyed synthetic fabric with double wire helix	<b>TEMPERATURE RANGE</b> -40°F to 150°F (-40°C to 66°C)

NOMINAL I.D. (INCHES) (MM)		NOMINAL O.D. (INCHES) (MM)		WORKING PRESSURE (PSI) (MPA)		VACUUM (IN/HG)	MIN. BEND RADIUS (INCHES) (MM)		WEIGHT (LB/FT) (KG/M)	
3/4	19.1	1.22	31	200	1.38	29	4	89	0.46	0.68
1	25.4	1.47	37.3	200	1.38	29	4	102	0.6	0.89
1 1/4	31.8	1.73	43.9	200	1.38	29	4	102	0.73	1.09
1 1/2	38.1	1.97	50	200	1.38	29	5	127	0.84	1.25
2	50.8	2.55	64.8	200	1.38	29	6	152	1.22	1.92
2 1/2	63.5	3.14	79.8	200	1.38	29	8	203	1.78	2.65
3	76.2	3.63	92.2	200	1.38	29	9	229	2.11	3.14
4	101.6	4.67	118.6	200	1.38	29	10	254	2.81	4.18

**INDUSTRY INTERCHANGE:** FabChem, Ultra-Chem, Blue Thunder, Chem-Cat, Renegade

\* RAGCO supports the autonomy of its locations to select the best products to service their markets. Subtle variations of these specifications may exist. Contact your RAGCO affiliate for confirmation.



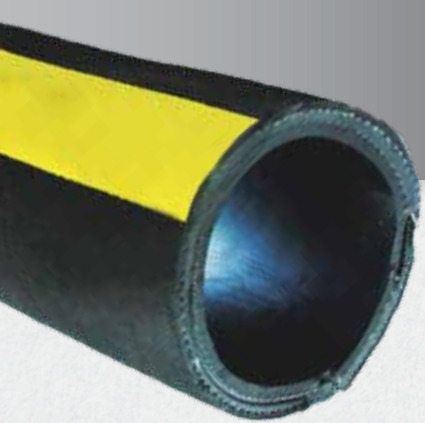

# RAGCO POSEIDON™ OILFIELD SUCTION HOSE

RAGCO Poseidon Oilfield Suction Hose is an exceptional product for use in transfer hose service, cleaning sediment from oil storage tanks, and other general service applications. The tube is an oil-resistant synthetic rubber. Do not use with gasoline or other refined products with aromatic content that exceeds 35%.

<b>TUBE</b>	Synthetic rubber	<b>REINFORCEMENT</b>	Spiral-plied synthetic fabric with wire helix
<b>COVER</b>	Black SBR synthetic rubber (smooth cover)	<b>TEMPERATURE</b>	-25°F to 180°F (-32°C to 82°C)

NOMINAL I.D. (INCHES) (MM)		NOMINAL O.D. (INCHES) (MM)		WORKING PRESSURE (PSI) (MPA)		VACUUM (IN/HG)	MIN. BEND RADIUS (INCHES) (MM)		WEIGHT (LB/FT) (KG/M)	
1	25.4	1.49	37.8	150	1.03	29	3	75	0.64	0.95
1 1/4	31.75	1.74	44.2	150	1.03	29	3	75	0.77	1.14
1 1/2	38.1	1.99	50.6	150	1.03	29	4	102	0.91	1.36
2	50.8	2.49	63.2	150	1.03	29	4.5	114	1.71	1.74
2 1/2	63.5	3.1	76.4	150	1.03	29	5.75	146	1.48	2.2
3	76.2	3.54	89.9	150	1.03	29	7	178	1.91	3.96
4	101.6	4.59	116.5	150	1.03	29	10	254	2.82	4.19



# HOT TAR & ASPHALT HOSE



Hot Tar & Asphalt Hose is an industrial suction and discharge hose designed to handle high-temperature materials such as hot asphalt, glue, oil, tar and wax to 300°F continuous and 350°F intermittent (149°C/177°C). The hose also handles refined fuels such as biodiesel (to B100 in dedicated service), diesel, ethanol and gasoline. The hose construction incorporates a dual wire helix that provides full suction capability, kink resistance and a path to conduct a static electrical charge to ground. The cover is resistant to abrasion, heat, oil and weathering.

<b>TUBE MATERIAL</b>	Black nitrile	<b>REINFORCEMENT</b>	Two textile plies with dual wire helix
<b>COVER</b>	Wrapped	<b>TEMPERATURE</b>	-20°F to 350°F

I.D.	O.D.	WORKING PRESSURE (PSI)	VACUUM (IN/HG)	MINIMUM BEND RADIUS	WEIGHT / FT
2"	2.72"	150	29	10"	1.8 lbs
3"	3.78"	150	29	15"	2.94 lbs
4"	4.80"	150	29	20"	3.89 lbs

**INDUSTRY INTERCHANGE:** Pyroflex, SS387

\* RAGCO supports the autonomy of its locations to select the best products to service their markets. Subtle variations of these specifications may exist. Contact your RAGCO affiliate for confirmation.



# FOOD SUCTION HOSE



## BULK FOOD SUCTION HOSE

For suction of flour, sugar, syrup, grains, or similar products. FDA-grade, white, natural-rubber tube. All sizes rated for full vacuum.

<b>CONSTRUCTION</b>	Tube is white natural rubber, FDA grade. Cover is natural rubber. Two-ply reinforcement with a steel wire helix.
<b>TEMPERATURE</b>	-40°F (-40°C) to +150°F (+66°C)

I.D.	O.D.	WORKING PRESSURE (PSI)	VACUUM (HG)	MIN. BEND RADIUS	WEIGHT/FT (LBS)
1"	1.49"	150	29	4 ½"	.69
1-1/2"	2.05"	150	29	5"	.98
2"	2.66"	150	29	6"	1.37
2-1/2"	3.07"	150	29	8"	1.67
3"	3.62"	150	29	10"	2.14
3-1/2"	4.21"	150	29	12"	2.6
4"	4.72"	150	29	20"	3.14
4-1/2"	5.27"	150	29	22"	3.94
5"	5.71"	150	29	24"	4.67
6"	6.77"	150	29	26"	5.98
8"	8.78"	150	29	32"	9.36
10"	10.83"	125	29	44"	11.57
12"	12.83"	100	29	60"	15.27

INDUSTRY INTERCHANGE: Tan Flextra, Type 96, 690S



# FOOD SUCTION HOSE CONTINUED

## LIQUID FOOD SUCTION HOSE



For suction of liquid food products. Tube resists oily material.

<b>CONSTRUCTION</b>	Tube is white nitrile rubber, FDA grade. Cover is nitrile. Two-ply reinforcement with a steel wire helix.
<b>TEMPERATURE</b>	-25°F (-32°C) to +200°F (+93°C)

I.D.	O.D.	WORKING PRESSURE (PSI)	VACUUM (HG)	MIN. BEND RADIUS	WEIGHT/FT (LBS)
¾"	1.10"	150	29	2 ½"	.34
1"	1.49"	150	29	3 1/8"	.45
1-1/2"	2.05"	150	29	4"	1.06
2"	2.66"	150	29	5"	1.35
3"	3.62"	150	29	6"	2.08
4"	4.72"	150	29	8"	3.21

**INDUSTRY INTERCHANGE:** Picord, Gray Shadow, SW432

\* RAGCO supports the autonomy of its locations to select the best products to service their markets. Subtle variations of these specifications may exist. Contact your RAGCO affiliate for confirmation.



# BREWERY/WINERY HOSE



A state-of-the-art designed rubber hose based on the specific requirements of the modern-day brewery or winery. Rugged but flexible construction with a super smooth white hose tube, this hose is for non-oily applications, is microbe-resistant, and has an EPDM cover that resists dirt scuffs and is easily cleaned. Built on stainless steel mandrels for cleanliness and meets FDA, USDA and 3-A (certificate #1376) requirements.

<b>TUBE MATERIAL</b>	White chlorobutyl (non-oily applications)	<b>COVER MATERIAL</b>	EPDM
<b>REINFORCEMENT</b>	Multiple plies of polyester tire cord, dual monofilament helix rods		
<b>TEMPERATURE</b>	-40°F (-40°C) to +240°F (+116°C) (Can be open-end steam-cleaned) CIP to 248°F (+120°C)		

I.D.	O.D.	W.P. (PSI)	MIN BEND RADIUS	VACUUM (HG)	WEIGHT/FT (LBS)
3/4"	1.41"	250	4"	Full	0.33
1"	1.64"	250	4"	Full	0.48
1 1/2"	2.14"	250	5"	Full	0.65
2"	2.77"	250	7"	Full	1.26
2 1/2"	3.29"	250	13"	Full	1.54

**INDUSTRY INTERCHANGE:** NovaBrew, Vintner



# STEAM HOSE



Rugged wire-braided steam hose recommended for saturated and super-heated steam applications. Used in shipyards, manufacturing, chemical and petroleum plants, food, lumber, pulp, and processing industries. Cover is weather- and ozone-resistant. Available with chlorobutyl tube.

<b>TUBE</b>	EPDM	<b>REINFORCEMENT</b>	Steel wire plies
<b>COVER</b>	EPDM	<b>TEMPERATURE</b>	-40°F to 450°F

ID	O.D.	WORKING PRESSURE (PSI)	VACCUM (IN/HG)	MIN. BEND RADIUS	WEIGHT/FT (LBS)
1/2"	1.00"	250	N/A	5.9"	0.4
3/4"	1.25"	250	N/A	8.3"	0.51
1"	1.5"	250	N/A	11"	0.67
1 1/4"	1.81"	250	N/A	14"	0.87
1 1/2"	2.13"	250	N/A	16.5"	1.11
2"	2.64"	250	N/A	22"	1.8
3"	3.81"	250	N/A	30"	3.17

**INDUSTRY INTERCHANGE:** Plicord Steam, BurstProof, Steam-Lance, Steam King, Concord

\* RAGCO supports the autonomy of its locations to select the best products to service their markets. Subtle variations of these specifications may exist. Contact your RAGCO affiliate for confirmation.





# SANDBLAST HOSE

Used with grit, aluminum oxide, glass beads, etc., and is ideal for rugged use in shipyards and construction sites.

<b>SAFETY FACTOR</b>	4:1	<b>REINFORCEMENT</b>	High tensile tire cord plies
<b>COVER MATERIAL</b>	Black, SBR (pin-pricked)	<b>TEMPERATURE</b>	-40°F to 190°F
<b>TUBE MATERIAL</b>	Black, SBR/GUM, wear-resistant, static-dissipating materials		

I.D.	O.D.	WORKING PRESSURE (PSI)	REINFORCEMENT PLYS	WEIGHT/FT
1/2"	1 1/8"	150	2	.4 lbs
3/4"	1 1/2"	150	4	.57 lbs
1"	1 7/8"	150	4	.94 lbs
1 1/4"	2 1/8"	150	4	1.18 lbs
1 1/2"	2 3/8"	150	4	1.35 lbs

**INDUSTRY INTERCHANGE:** Plicord Blast, Blast-Flex, Sand Blast 7245, Concord



# MATERIAL SUCTION HOSE



Hard-wall hose designed with a high abrasion-resistant tube. Ideal for applications where suction and/or discharge of abrasive media is required. Can be crimped or banded to make assemblies per your specifications.

<b>TUBE</b>	Gum rubber or gum rubber blend	<b>REINFORCEMENT</b>	Fiber cord plies, helical wire
<b>COVER</b>	SBR	<b>TEMPERATURE</b>	-40°F to 185°F

I.D.	O.D.	WORKING PRESSURE (PSI)	VACCUM (IN/HG)	MIN. BEND RADIUS	WEIGHT/FT (LBS)
1 1/4"	1.81"	75	29	4"	0.77
1 1/2"	2.1"	75	29	4"	1.11
2"	2.6"	75	29	12"	1.3
2 1/2"	3.11"	75	29	17"	1.65
3"	3.66"	75	29	18"	2.25
4"	4.69"	75	29	24"	2.93
5"	5.7"	75	29	30"	3.83
6"	6.73"	75	29	32"	5
8"	9.13"	60	29	40"	10.05

# MATERIAL DISCHARGE HOSE



Soft-wall hose designed with a high abrasion-resistant tube. Ideal for applications where discharging of abrasive media is required. Can be crimped or banded to make assemblies per your specifications. Available in 1/8" 3/16" and 1/4" tube.

<b>TUBE</b>	Nitrile/SBR blend, static dissipating	<b>REINFORCEMENT</b>	Fiber cord plies
<b>COVER</b>	SBR	<b>TEMPERATURE</b>	-40°F to 185°F

I.D.	O.D.	WORKING PRESSURE (PSI)	VACCUM (IN/HG)	MIN. BEND RADIUS	WEIGHT/FT (LBS)
4"	4.68"	75	N/A	40"	2.42
5"	5.68"	75	N/A	50"	2.92

\* 3/16" thick tube shown.

**INDUSTRY INTERCHANGE:** Black Softwall, SS147, 609W, Lynx

\* RAGCO supports the autonomy of its locations to select the best products to service their markets. Subtle variations of these specifications may exist. Contact your RAGCO affiliate for confirmation.





# HOT AIR BLOWER HOSE

Premium level hose for connecting blower to flow lines on dry-bulk trailers. The tube of this hose is designed to handle the heat from the air blower supply, and the cover is designed to handle the effects of weather and ozone. Can be crimped or banded to make assemblies per your specifications.

<b>TUBE</b>	EPDM	<b>REINFORCEMENT</b>	High tensile fiber cord plies, metal helix
<b>COVER</b>	Brown EPDM	<b>TEMPERATURE</b>	-40°F to 225°F (350°F intermittent)

I.D.	O.D.	REIN. PLYS	MAX. W.P. AT 68°F	MIN. BEND RADIUS	WEIGHT
3 in	3.56 in	2	50 psi	5.50 in	1.93 lb/ft
4 in	4.60 in	2	50 psi	7.00 in	2.65 lb/ft

**INDUSTRY INTERCHANGE:** Pyroflex, Transporter, Dragon Breath, Wildcat



# PRESSURE WASHER HOSE

This wire-reinforced hose is rated for 3,000 psi – 5,000 psi service. It's coupled with 3/8" MPT swivel X 3/8" MPT stationary fittings with ergonomic bend restrictors at each end. It can be used with hot or cold water and mild detergents, but is not recommended for steam service. Good to 212°F.

<b>COLOR</b>	Black	<b>SIZE</b>	3/8" I.D. x 50'
<b>FITTINGS</b>	3/8" MPT Swivel X 3/8" MPT Stationary		

\*Available in custom sizes, lengths, and configurations.

STANDARD LENGTHS	COUPLING	I.D. X LENGTH	MAX. W.P.	WEIGHT
50 ft	3/8" MNPT x 3/8" MSPT with Ergonomic Bend Restrictor Each End	3/8" x 50'	3000 psi	10.02 lb/ft

\*Tables display most prevalent versions of material. Unlisted durometers and manipulations to these specification can be custom manufactured.







# PLASTIC HOSE

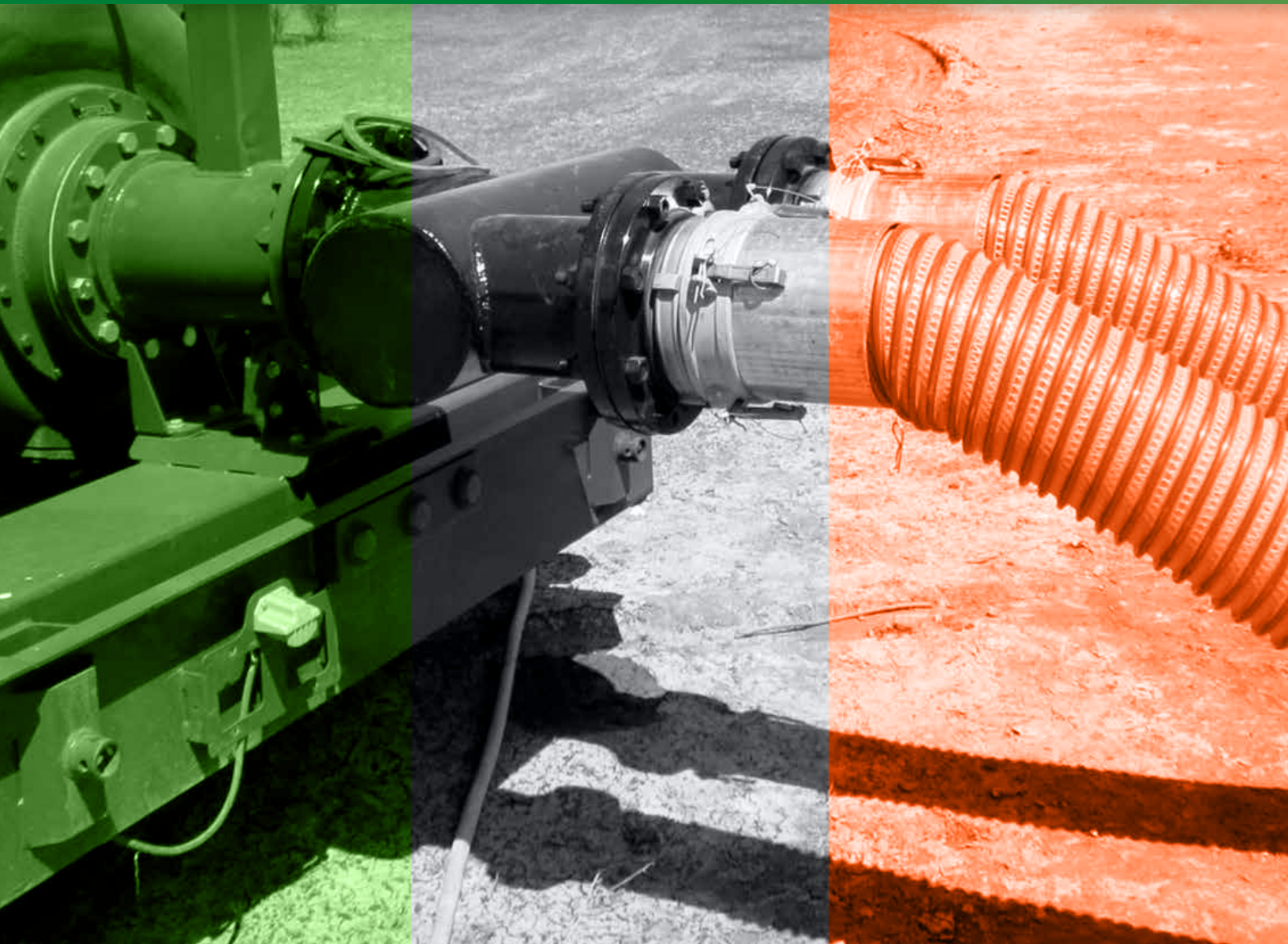





# GREEN PVC SUCTION HOSE

Economical suction hose for water and light chemical applications. Can be crimped or banded to make assemblies per your specifications.

<b>CONSTRUCTION</b>	Green PVC w/ white helix
<b>TEMPERATURE RANGE</b>	-10°F to 130°F / -32°C to 85°C

I.D.	O.D.	REC W.P. @ 72° F (PSI)	APPROX W.P. @ 140° F (PSI)	VACUUM RATING (IN/ HG)	REC MIN BEND RADIUS @ 72° F (INCH)	APPROX BURST PRESSURE @ 72° F (PSI)	APPROX WEIGHT (LBS/ FT)
3/4"	1.01"	100	42	28	2	300	0.2
1"	1.27"	90	42	28	3	300	0.27
1 1/4"	1.53"	90	42	28	4	270	0.36
1 1/2"	1.82"	90	42	28	5	270	0.47
2"	2.36"	70	37	28	6	210	0.636
2 1/2"	2.98"	65	32	28	8	195	0.92
3"	3.44"	55	28	28	9	165	1.2
4"	4.52"	50	28	28	13	150	1.87
5"	5.65"	45	CALL	28	21	135	3
6"	6.8"	45	CALL	28	24	135	4.56
8"	8.95"	40	CALL	28	35	120	7.05
10"	11.34"	40	CALL	28	41	120	12.37
12"	13.39"	35	CALL	26	53	105	15.66



# CLEAR PVC SUCTION HOSE



Economical suction hose for water and light chemical applications where inspection of material flow is necessary. Available in FDA food grade.

<b>CONSTRUCTION</b>	Clear PVC w/ white helix
<b>TEMPERATURE RANGE</b>	-10°F to 130°F / -32°C to 85°C

I.D.	O.D.	REC W.P. @ 72° F (PSI)	W.P. @ 149	VACUUM RATING (IN/ HG)	REC MIN BEND RADIUS @ 72° F (INCH)	APPROX BURST PRESSURE @ 72° F (PSI)	APPROX WEIGHT (LBS/ FT)
3/4"	1.02"	100	42	28	2	300	0.21
1"	1.29"	90	42	28	3	300	0.29
1 1/4"	1.84"	90	42	28	4	270	0.38
1 1/2"	1.84"	90	42	28	4	270	0.49
2"	2.39"	70	37	28	5	210	0.71
1 1/2"	2.92"	65	32	28	7	195	0.98
3"	3.46"	55	28	28	8	165	1.28
4"	4.56"	50	28	28	12	150	2.02
5"	5.65"	45	CALL	28	20	135	2.97
6"	6.8"	45	CALL	28	23	135	4.39
8"	8.95"	40	CALL	28	34	120	6.79
10"	11.34"	40	CALL	28	40	120	11.88
12"	13.19"	35	CALL	28	50	105	15.07

\* RAGCO supports the autonomy of its locations to select the best products to service their markets. Subtle variations of these specifications may exist. Contact your RAGCO affiliate for confirmation.



# CORRUGATED PVC SUCTION HOSE

## HEAVY DUTY

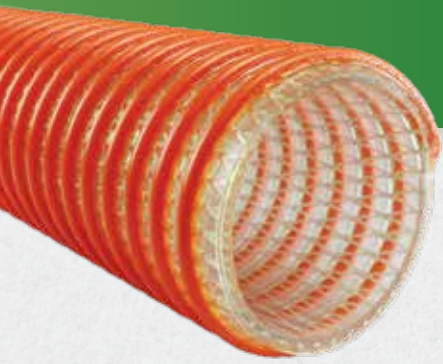

Heavy-duty suction and discharge hose for use in a variety of industries, such as rental pumping equipment and applications where the hose needs to slide easily, or visual confirmation of material flow is necessary.

<b>TUBE AND COVER</b>	Clear, flexible PVC with synthetic yarn braiding	<b>REINFORCEMENT</b>	Orange, rigid PVC helix
<b>SAFETY FACTOR</b>	3:1	<b>TEMPERATURE</b>	-4°F to +150°F

I.D.	O.D.	RECOM. REC W.P. @ 72° F (PSI)	APPROX BURST PRESSURE @ 72° F (PSI)	VACUUM RATING @ 72° F (IN/HG)	REC MIN BEND RADIUS @ 72° F (INCH)	APPROX WEIGHT (LBS/FT)
1"	1.38"	100	400	28	3	0.27
1 1/4"	1.66"	100	400	28	3	0.33
1 1/2"	1.89"	100	280	28	4	0.36
2"	2.45"	100	280	28	5	0.54
3"	3.61"	100	280	28	7	1.07
4"	4.73"	75	200	28	8	1.74
6"	7.13"	70	180	28	12	3.81
8"	9.3"	50	150	28	30	5
10"	11.5"	35	105	28	44	7.48
12"	13.77"	30	100	25	80	11.25



# BLUE PVC LAY-FLAT DISCHARGE HOSE AND ASSEMBLIES



Economical, lightweight, lay-flat hose for light-duty discharge applications. Tube and cover are simultaneously extruded for maximum possible bonding during manufacturing. Can be crimped or banded to make assemblies per your specifications.

<b>CONSTRUCTION</b>	Blue PVC, 3-ply polyester yarn	<b>TEMPERATURE RANGE</b>	-5°F to 170°F
---------------------	--------------------------------	--------------------------	---------------

## HOSE CHART

I.D.	I.D.	APPROX. WALL	MAX. W.P. AT 70°F PSI	DESIGN B.P. PSI	APPROX. WEIGHT/FT
3/4"	0.79"	0.048"	140 psi	425	.08 lbs
1"	1.04"	0.052"	110 psi	340	.11 lbs
1¼"	1.30"	0.056"	80 psi	255	.14 lbs
1½"	1.61"	0.059"	80 psi	240	.19 lbs
2"	2.09"	0.059"	80 psi	240	.25 lbs
2½"	2.56"	0.059"	65 psi	200	.30 lbs
3"	3.07"	0.063"	80 psi	240	.36 lbs
4"	4.13"	0.067"	70 psi	210	.53 lbs
5"	5.07"	0.071"	40 psi	130	.64 lbs
6"	6.16"	0.075"	60 psi	200	.87 lbs
8"	8.15"	0.087"	35 psi	100	1.30 lbs
10"	10.20"	0.111"	35 psi	100	1.88 lbs
12"	12.13"	0.118"	35 psi	100	2.44 lbs
14"	14.14"	0.118"	30 psi	85	2.70 lbs
16"	16.14"	0.118"	30 psi	85	3.08 lbs

\* RAGCO supports the autonomy of its locations to select the best products to service their markets. Subtle variations of these specifications may exist. Contact your RAGCO affiliate for confirmation.



# BLUE PVC LAY-FLAT DISCHARGE HOSE CONTINUED

Pre-coupled, 50' sections coiled for convenient transportation and storage. Available in multiple configurations. Doubled-banded at each end.

## ASSEMBLY CHART

COUPLING	I.D. X LENGTH	MAX. W.P. AT 68°F	WEIGHT (EA.)
1 1/2" Pin Lug (M x F)	1 1/2" x 50'	85 psi 5.86 bar	9 lbs
1 1/2" Alum Cam Lock (C x E)	1 1/2" x 50'	85 psi 5.86 bar	9 lbs
1-1/2 polypropylene Cam Lock (C x E)	1-1/2" x 50'	85 psi 5.86 bar	9 lbs
2" Pin Lug (M x F)	2" x 50'	85 psi 5.86 bar	12 lbs
2" Alum Cam Lock (C x E)	2" x 50'	85 psi 5.86 bar	12 lbs
2" Polypropylene Cam Lock (C x E)	2" x 50'	85 psi 5.86 bar	12 lbs
3" Pin Lug (M x F)	3" x 50'	70 psi 4.83 bar	22 lbs
3" Alum Cam Lock (C x E)	3" x 50'	70 psi 4.83 bar	22 lbs
3" Polypropylene Cam Lock (C x E)	3" x 50'	70 psi 4.83 bar	22 lbs

### DISCHARGE HOSE WITH CAM & GROOVE ASSEMBLY



### DISCHARGE HOSE WITH PIN LUG ASSEMBLY





# RED PVC LAY-FLAT DISCHARGE HOSE

A heavy-duty PVC lay-flat hose designed for higher pressure applications. Considered a “step up” from the standard blue PVC lay-flat hose. An ideal hose for pump discharge, tank cleaning, dewatering, irrigation and wash-down applications.



<b>TUBE AND COVER</b>	Red, homogeneous virgin PVC	<b>REINFORCEMENT</b>	High-tensile polyester yarn
<b>SAFETY FACTOR</b>	3:1	<b>TEMPERATURE</b>	-10°F to +120°F

I.D.	O.D.	APPROX. WALL	MAX. W.P. AT 70°F (PSI)	APPROX. WT. 300FT (USA)
1-1/2"	1.61"	0.079"	150 psi	80 lbs.
2"	2.09"	0.087"	150 psi	103 lbs
2-1/2"	2.56"	0.091"	150 psi	124 lbs
3"	3.07"	0.095"	150 psi	164 lbs
4"	4.13"	0.102"	150 psi	254 lbs
6"	6.18"	0.119"	150 psi	400lbs
8"	8.19"	0.134"	115 psi	CALL

\* RAGCO supports the autonomy of its locations to select the best products to service their markets. Subtle variations of these specifications may exist. Contact your RAGCO affiliate for confirmation.



# NITRILE/PVC LAY-FLAT DISCHARGE HOSE

## YELLOW & BLACK

For the transfer of water, wash-down, jetting and irrigation. Oil-resistant tube and cover. Resists heat and cold, abrasion, ozone and UV. This hose is lightweight and flexible. For use in industrial wash-down, irrigation, general dewatering, pump discharge and drainage.

<b>TUBE AND COVER</b>	Black or yellow PVC/Nitrile
<b>REINFORCEMENT</b>	Polyester
<b>TEMPERATURE</b>	-20°F to +176°F

I.D.	WALL THICKNESS	MAX. W.P. AT 68°F	BURST PRESSURE	WEIGHT
3/4 in	0.110 in	250 psi	800 psi	0.10 lb/ft
1 in	0.110 in	250 psi	800 psi	0.14 lb/ft
1 1/2 in	0.110 in	250 psi	800 psi	0.26 lb/ft
2 in	0.110 in	250 psi	800 psi	0.34 lb/ft
2 1/2 in	0.110 in	250 psi	800 psi	0.47 lb/ft
3 in	0.110 in	250 psi	750 psi	0.65 lb/ft
4 in	0.110 in	200 psi	600 psi	0.83 lb/ft
6 in	0.110 in	150 psi	450 psi	1.60 lb/ft

### BLACK DISCHARGE HOSE



### YELLOW DISCHARGE HOSE

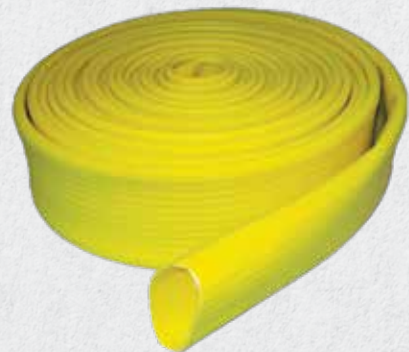



# CLEAR BRAIDED PVC TUBING

Food-grade, clear hose with textile braided reinforcement for added strength. For water and light chemical transfer applications where visual inspection of material flow is necessary. FDA layline. Often used in food processing. Can be crimped or banded to make assemblies per your specifications.



<b>CONSTRUCTION</b>	Clear PVC tube, textile braid
<b>TEMPERATURE RANGE</b>	-10°F to 130°F

I.D.	O.D.	MAX WORKING PRESSURE @ 72° F (PSI)	DESIGN BURST PRESSURE @ 72° F (PSI)	APPROX WEIGHT (LBS/ FT)
3/16"	.41"	250	1,000	0.044
1/4"	.47"	250	1,000	0.057
5/16"	.54"	200	1,000	0.08
3/8"	.625"	200	800	0.09
1/2"	.75"	200	800	0.14
5/8"	.88"	200	800	0.18
3/4"	1.03"	175	600	0.22
1"	1.32"	125	500	0.30
1 1/4"	1.75"	100	400	0.46
1 1/2"	2"	75	300	0.64
2"	2 1/2"	75	300	0.94

\* RAGCO supports the autonomy of its locations to select the best products to service their markets. Subtle variations of these specifications may exist. Contact your RAGCO affiliate for confirmation.



# CLEAR PVC TUBING

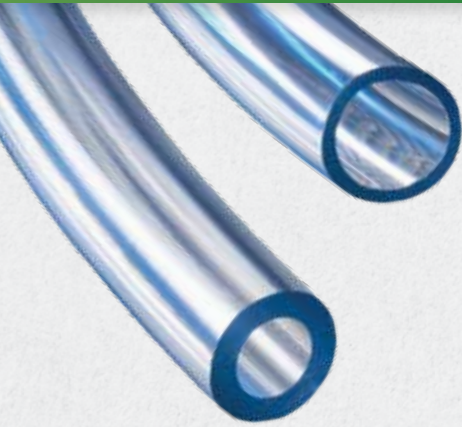

Food-grade, clear hose for water and light chemical transfer applications where visual inspection of material flow is necessary. Available in various wall thicknesses in certain sizes. FDA approved. Can be crimped or banded to make assemblies per your specifications.

**CONSTRUCTION** Clear PVC tube

**TEMPERATURE RANGE** -10°F to 130°F

I.D.	O.D.	WALL THICKNESS (INCH)	MAX W.P. @ 72° F (PSI)	APPROX WEIGHT (LBS/ FT)
1/8"	1/4"	1/16"	70	0.02
3/16"	5/16"	1/16"	70	0.027
1/4"	3/8"	1/16"	60	0.034
1/4"	7/16"	3/32"	60	0.055
1/4"	1/2"	1/8"	70	0.08
5/16"	7/16"	1/16"	50	0.04
5/16"	1/2"	3/32"	60	0.065
3/8"	1/2"	1/16"	50	0.047
3/8"	9/16"	3/32"	55	0.075
3/8"	5/8"	1/8"	60	0.107
1/2"	5/8"	1/16"	40	0.06
1/2"	3/4"	1/8"	50	0.134
9/16"	7/8"	5/32"	45	0.161
5/8"	7/8"	5/32"	45	0.161
3/4"	1"	1/8"	35	0.188
7/8"	1 1/8"	1/8"	35	0.218
1"	1 1/4"	1/8"	30	0.241
1 1/4"	1 3/4"	1/4"	50	0.322
1 1/2"	2"	1/4"	40	0.375
2"	2 3/8"	3/16"	25	0.482



# SPRING WIRE PVC HOSE

Food grade, clear hose with steel spring-wire reinforcement suitable for vacuum service. For water, food and beverage dispensing, deionized water systems, and light chemical transfer applications where visual inspection of material flow is necessary. FDA approved. Can be crimped or banded to make assemblies per your specifications.



**CONSTRUCTION** Clear PVC tube, electro-galvanized steel spring wire

**TEMPERATURE RANGE** -10°F to 140°F

I.D.	O.D.	MAX. W.P. AT 70°F (PSI)	APPROX. WT. (LBS/FT)
1/4"	1/2"	210	.09
3/8"	5/8"	180	.12
1/2"	13/16"	150	.21
5/8"	1"	100	.32
3/4"	1-1/8"	100	.36
1"	1-3/8"	84	.47
1-1/4"	1-3/4"	84	.78
1-1/2"	2"	84	.86
2"	2-1/2"	70	1.12

\* RAGCO supports the autonomy of its locations to select the best products to service their markets. Subtle variations of these specifications may exist. Contact your RAGCO affiliate for confirmation.





# FIRE & MILL HOSE







# FIRE HOSE

all be of superior quality and workmanship. The hose shall withstand of front-line firefighting, and other discharge applications.

## SYNTHETIC, ALL-POLYESTER DOUBLE JACKET

## MILDEW RESISTANT

## HEAVY-WALL EPDM RUBBER LINER OR POLYURETHANE LINER, NSF-61 COMPLIANT

## AVAILABLE IN WHITE, BLUE, AND ORANGE

**Jacket Construction:** Double-jacket hose manufactured to this specification shall be tightly woven with filament polyester yarn in the filler and ring-spun polyester yarn in the warp of both the inside and outside jackets. The hose shall be resistant to most chemicals and petrol products, and resist deterioration due to exposure to UV-rays and ozone. It shall not be affected by rot or mildew. The inside and outside jackets shall be manufactured with a minimum pick count of 9.5 picks per inch for increased strength and abrasion resistance. The inside jacket shall be manufactured using a reverse-twill process to reduce friction loss. The inside jacket shall be manufactured on a circular loom in a clockwise direction and the outside jacket in a counter-clockwise direction. The hose must be of sufficient body and weight to meet the demands of heavy-duty firefighting usage.

**Abrasion Impregnation:** Hose assemblies shall be available with the special polyurethane-based polymer impregnation for added abrasion resistance and ease in identification.

**Lining:** The liner shall be a single-ply, synthetic, high-tensile EPDM rubber or a polyether-based urethane. The liner shall be free from dirt, blisters, and other imperfections. Inside surface shall be smooth and free from corrugations. The adhesion between the liner and the jacket shall be such that the rate of separation of a 1.50" strip of lining, transversely cut, shall not be greater than 1" per minute under a 12-pound weight.

**Performance:** The minimum burst test pressure on all diameters shall be 900 PSI/62 Bar.

**Couplings:** Unless otherwise specified, each length of hose shall be fitted with a set of cast or forged brass couplings.

I.D.	SERVICE TEST	PROOF TEST	BURST TEST	BOWL SIZE	WEIGHT / FT
1 1/2"	300 psi	600 psi	900 psi	1 15/16"	.34 lbs
1 3/4"	300 psi	600 psi	900 psi	2 1/8"	.38 lbs
2 1/2"	300 psi	600 psi	900 psi	3"	.54 lbs
4"	300 psi	600 psi	900 psi	4 1/2"	1.0 lbs





# DJ MILL HOSE & ASSEMBLIES



## BULK HOSE

A double covered, lightweight, and flexible discharge hose for municipal washdown, hydrant water supply lines, equipment & pump rental, shipyard washdown, and other various discharge applications. Increased abrasion resistance and pressure rating. This economical hose rolls up flat for easy storage and transfer.

<b>TUBE</b>	SBR	<b>TEMPERATURE RANGE</b>	-25°F (-32°C) to 185°F (+85°C)
<b>COVER</b>	Double jacket white polyester	<b>STANDARD LENGTHS</b>	50', 100'

## HOSE CHART

I.D.	SERV. PRESS.	TEST PRESS.	WEIGHT
1 1/2 in	300 psi	600 psi	0.26 lb/ft
38.10 mm	20.68 bar	41.36 bar	0.39 kg/m
2 in	300 psi	600 psi	0.33 lb/ft
50.80 mm	20.68 bar	41.36 bar	0.49 kg/m
2 1/2 in	300 psi	600 psi	0.45 lb/ft
63.50 mm	20.68 bar	41.36 bar	0.67 kg/m

## ASSEMBLIES

All of the same great features and benefits as our bulk hose, and now with the added benefit of coupled assemblies. Couplings are internally expanded, aluminum, hard-coated NPS or NST Male x Female rocker lug. For the transfer of water, wash-down, jetting and irrigation.

## ASSEMBLIES CHART

I.D.	STD LENGTH	THREAD TYPE	WEIGHT
1 1/2 in	50 ft	NPS	15.00 lb/ft
1 1/2 in	50 ft	NST	15.00 lb/ft
2 in	50 ft	NPS	20.00 lb/ft
2 1/2 in	50 ft	NPS	25.00 lb/ft
2 1/2 in	50 ft	NST	25.00 lb/ft



\* RAGCO supports the autonomy of its locations to select the best products to service their markets. Subtle variations of these specifications may exist. Contact your RAGCO affiliate for confirmation.





# SJ HOSE & ASSEMBLIES

Heavy-duty, but lightweight synthetic cover for better abrasion resistance and abuse. Higher working pressures. For water discharge service in rental yards, fleet service, municipal wash-down, utility dewatering. Available in bulk hose, standard and custom assemblies.

<b>TUBE</b>	SBR	<b>TEMPERATURE RANGE</b>	-25°F to 185°F
<b>COVER</b>	White polyester jacket	<b>STANDARD LENGTHS</b>	50', 100'

## HOSE CHART

I.D.	CPLNG. BOWL	SERV. PRESS.	WEIGHT
1 1/2 in	1.81 in	230 psi	0.23 lb/ft
2 in	2.31 in	230 psi	0.28 lb/ft
2 1/2 in	2.81 in	200 psi	0.39 lb/ft
3 in	3.38 in	200 psi	0.50 lb/ft
4 in	4.38 in	200 psi	0.66 lb/ft

## ASSEMBLIES CHART

I.D.	LENGTH	COUPLING	WEIGHT
1 1/2 in	50FT	Pin Lug	15 lbs
1 1/2 in	50FT	C x E	15 lbs
2 in	50FT	Pin Lug	19 lbs
2 in	50FT	C x E	19 lbs
3 in	50FT	Pin Lug	22 lbs
3 in	50FT	C x E	22 lbs

### PIN LUG ASSEMBLY



### CAMLOCK ASSEMBLY







# METAL HOSE





# ANNUFLEX STANDARD METAL HOSE



Annuflex is the standard of Hose Master's extensive line of high-performance, annular-corrugated, stainless-steel hoses. Proprietary technology ensures the excellent life cycle of the hose, with minimum effort to flex or bend the hose.

INSIDE DIAMETER (IN)	NUMBER OF BRAIDS (#)	OUTSIDE DIAMETER (IN)	STATIC MIN. BEND RADIUS (IN)	DYNAMIC MIN. BEND RADIUS (IN)	MAXIMUM WORKING PRESSURE (PSI)	BURST PRESSURE (PSI)	WEIGHT PER FOOT (LBS)
1/4	0	0.41	1.0	4.5	90	n/a	0.04
	1	0.47			1800	7233	0.11
	2	0.53			2700	9100	0.18
3/8	0	0.65	1.2	5.0	70	n/a	0.10
	1	0.71			1558	6230	0.20
	2	0.77			2336	9345	0.30
1/2	0	0.77	1.5	5.5	70	n/a	0.11
	1	0.83			1186	4743	0.22
	2	0.89			1779	7115	0.33
5/8	0	0.96	1.8	7.0	57	n/a	0.17
	1	1.02			1205	4820	0.33
	2	1.08			1808	7230	0.49
3/4	0	1.16	2.1	8.0	43	n/a	0.19
	1	1.22			898	3591	0.37
	2	1.28			1347	5387	0.55
1	0	1.47	2.7	9.0	43	n/a	0.26
	1	1.53			718	2872	0.50
	2	1.59			1077	4308	0.74
1 1/4	0	1.75	3.1	10.0	43	n/a	0.29
	1	1.83			645	2581	0.61
	2	1.91			968	3872	0.93
1 1/2	0	2.08	3.9	11.0	28	n/a	0.47
	1	2.16			531	2125	0.85
	2	2.24			797	3188	1.23
2	0	2.61	5.1	13.0	14	n/a	0.59
	1	2.69			449	1797	1.11
	2	2.77			674	2696	1.63



# ANNUFLEX CONTINUED

INSIDE DIAMETER (IN)	NUMBER OF BRAIDS (#)	OUTSIDE DIAMETER (IN)	STATIC MIN. BEND RADIUS (IN)	DYNAMIC MIN. BEND RADIUS (IN)	MAXIMUM WORKING PRESSURE (PSI)	BURST PRESSURE (PSI)	WEIGHT PER FOOT (LBS)
2 1/2	0	3.40	6.8	16.0	14	n/a	0.84
	1	3.50			417	1669	1.64
	2	3.60			626	2504	2.44
3	0	3.88	7.8	18.0	14	n/a	1.18
	1	3.98			346	1384	2.06
	2	4.08			519	2076	2.94
4	0	4.96	9.8	22.0	14	n/a	1.41
	1	5.06			299	1194	2.69
	2	5.16			448	1791	3.97
5	0	6.00	12.8	28.0	14	n/a	2.18
	1	6.12			275	1099	3.61
	2	6.24			412	1649	5.04
6	0	7.01	14.8	32.0	11	n/a	2.69
	1	7.13			210	839	4.44
	2	7.25			315	1259	6.19
8*	0	9.04	18.0	29.0	3	n/a	4.88
	1	9.32			250	1000	8.21
	2	9.60			360	1446	11.53
10*	0	11.34	21.0	34.0	4	n/a	7.42
	1	11.56			175	700	11.05
	2	11.78			310	1247	14.67
12*	0	13.45	27.0	44.0	3	n/a	11.04
	1	13.73			185	745	16.71
	2	14.00			325	1308	22.38

\*8", 10" and 12" diameters are supplied with braided braid.

**Notes:** The minimum bend radius is measured from the centerline of the hose. The working pressure decreases with temperature – see derating factor. For rapid pressure fluctuations, consult the factory.

\*The specifications listed represent Hose Master LLC products only and do not represent any other manufacturer's products.



# MASTERFLEX HIGH-FLEXIBILITY METAL HOSE



Masterflex is manufactured using the same high-quality process used to make Annuflex hose, but the number of corrugations per foot is increased to allow for greater flexibility.

INSIDE DIAMETER (IN)	NUMBER OF BRAIDS (#)	OUTSIDE DIAMETER (IN)	STATIC MIN. BEND RADIUS (IN)	DYNAMIC MIN. BEND RADIUS (IN)	MAXIMUM WORKING PRESSURE (PSI)	BURST PRESSURE (PSI)	WEIGHT PER FOOT (LBS)
1/4	0	0.42	0.9	3.7	90	n/a	0.07
	1	0.48			1800	7233	0.14
	2	0.54			2700	9100	0.20
3/8	0	0.65	1	4	70	n/a	0.15
	1	0.71			1558	6230	0.25
	2	0.77			2336	9345	0.36
1/2	0	0.77	1.2	4.4	70	n/a	0.18
	1	0.83			1186	4743	0.32
	2	0.89			1779	7115	0.47
5/8	0	0.96	1.4	5.6	57	n/a	0.19
	1	1.02			1205	4820	0.37
	2	1.08			1808	7230	0.54
3/4	0	1.16	1.7	6.4	43	n/a	0.31
	1	1.22			898	3591	0.53
	2	1.28			1347	5387	0.74
1	0	1.47	2.1	7.1	43	n/a	0.41
	1	1.53			718	2872	0.76
	2	1.63			1077	4308	1.11
1 1/4	0	1.75	2.5	7.9	43	n/a	0.63
	1	1.83			645	2581	1.00
	2	1.91			968	3872	1.37
1 1/2	0	2.08	3.1	8.7	28	n/a	0.70
	1	2.16			531	2125	1.16
	2	2.24			797	3188	1.63
2	0	2.61	4	10.3	14	n/a	0.88
	1	2.69			449	1797	1.44
	2	2.77			674	2696	1.99
2 1/2	0	3.40	5.4	12.8	14	n/a	1.36
	1	3.50			417	1669	2.16
	2	3.60			626	2504	2.96
3	0	3.88	6.3	14.5	14	n/a	1.63
	1	3.98			346	1384	2.50
	2	4.08			519	2076	3.37
4	0	4.96	7.7	17.4	14	n/a	2.53
	1	5.06			299	1194	3.90
	2	5.16			448	1791	5.29
5	0	6.00	10	21.9	14	n/a	4.07
	1	6.12			275	1099	5.53
	2	6.24			412	1649	6.99
6	0	7.01	11.6	25	11	n/a	4.46
	1	7.13			210	839	6.34
	2	7.25			315	1259	8.22

**Notes:** The minimum bend radius is measured from the centerline of the hose. The working pressure decreases with temperature – see derating factor. For rapid pressure fluctuations, consult the factory.

The specifications listed represent Hose Master LLC products only and do not represent any other manufacturer's products.



# PRESSUREFLEX HP<sup>®</sup> HIGH-PRESSURE METAL HOSE

Pressureflex HP<sup>®</sup> is Hose Master's high-pressure, annular-corrugated metal hose. Pressureflex HP is made from heavy-wall stainless steel, and offers flexibility and dependability when higher pressures are a factor.



INSIDE DIAMETER (IN)	NUMBER OF BRAIDS (#)	OUTSIDE DIAMETER (IN)	STATIC MIN. BEND RADIUS (IN.)	DYNAMIC MIN. BEND RADIUS (IN)	MAXIMUM WORKING PRESSURE (PSI)	BURST PRESSURE (PSI)	WEIGHT PER FOOT (LBS)
1/4	0	0.423	1	5.5	450	n/a	0.08
	1	0.483			3000	12000	0.15
	2	0.543			4000	16000	0.22
3/8	0	0.655	1.5	8.5	400	n/a	0.12
	1	0.735			2400	9600	0.31
	2	0.815			3300	14000	0.48
1/2	0	0.774	2.5	10	400	n/a	0.24
	1	0.854			2400	9600	0.40
	2	0.934			3200	12800	0.57
3/4	0	1.13	4	8	220	n/a	0.41
	1	1.19			1100	4430	0.58
	2	1.25			1650	6696	0.76
1	0	1.43	5	9	190	n/a	0.52
	1	1.49			1000	4187	0.76
	2	1.55			1400	5837	0.99
1 1/4	0	1.74	6.5	12	200	n/a	0.76
	1	1.82			900	3758	1.13
	2	1.90			1350	5494	1.50
1 1/2	0	2.10	7.5	13	90	n/a	1.13
	1	2.18			750	3070	1.54
	2	2.26			1200	4842	1.96
2	0	2.55	9	15	105	n/a	1.10
	1	2.68			800	3304	2.29
	2	2.80			1150	4738	3.47
2 1/2	0	3.35	10.5	17	46	n/a	1.75
	1	3.48			575	2461	3.05
	2	3.60			900	3857	4.35
3	0	3.67	12	20	36	n/a	1.92
	1	3.79			550	2252	3.18
	2	3.92			800	3254	4.46
4	0	4.92	9.8	25	23	n/a	2.29
	1	5.04			425	1754	4.12
	2	5.16			575	2350	5.98
5*	0	5.96	12.8	34	28	n/a	3.03
	1	6.13			331	1324	5.14
6*	0	6.97	14.8	40	23	n/a	3.74
	1	7.22			285	1140	6.44

\*5-inch and 6-inch diameters are supplied with braided braid

**Notes:** Some hose material and braid code combinations may be unavailable. Contact Hose Master Customer Service at 800-221-2319 for available combinations of hose material and braid alloys by hose size. The minimum bend radius is measured from the centerline of the hose. The working pressure decreases with temperature – see derating factor. For rapid pressure fluctuations, consult the factory.

The specifications listed represent Hose Master LLC products only and do not represent any other manufacturer's products.

\* RAGCO supports the autonomy of its locations to select the best products to service their markets. Subtle variations of these specifications may exist. Contact your RAGCO affiliate for confirmation.



# CHEMKING™ HIGH CHEMICAL-RESISTANCE METAL HOSE



ChemKing™ is Hose Master's chemical transfer hose. ChemKing offers excellent corrosion resistance to many of the most severe applications found in chemical processing.

INSIDE DIAMETER (IN)	NUMBER OF BRAIDS (#)	OUTSIDE DIAMETER (IN)	STATIC MIN. BEND RADIUS (IN)	DYNAMIC MIN. BEND RADIUS (IN)	MAXIMUM WORKING PRESSURE (PSI)	BURST PRESSURE (PSI)	WEIGHT PER FOOT (LBS)
1/2	0	0.77	1.5	5.5	70	n/a	0.11
	1	0.83			1186	4743	0.22
	2	0.89			1779	7115	0.33
3/4	0	1.16	2.1	8	43	n/a	0.19
	1	1.22			898	3591	0.37
	2	1.28			1347	5387	0.55
1	0	1.47	2.7	9	43	n/a	0.26
	1	1.53			718	2872	0.50
	2	1.59			1077	4308	0.74
1 1/2	0	2.08	3.9	11	28	n/a	0.47
	1	2.16			531	2125	0.85
	2	2.24			797	3188	1.23
2	0	2.61	5.1	13	14	n/a	0.59
	1	2.69			449	1797	1.11
	2	2.77			674	2696	1.63
3	0	3.88	7.8	18	14	n/a	1.18
	1	3.98			346	1384	2.06
	2	4.08			519	2076	2.94
4*	0	4.96	9.8	22	14	n/a	1.41
	1	5.06			299	1194	2.47
	2	5.16			448	1791	3.53
5*	0	6.00	12.8	28	14	n/a	2.18
	1	6.12			275	1099	3.61
	2	6.24			412	1646	5.04
6*	0	7.01	14.8	32	11	n/a	2.69
	1	7.13			210	839	4.44
	2	7.25			315	1259	6.19

\*4", 5", and 6" diameters; consult factory for delivery.

**Notes:** The minimum bend radius is measured from the centerline of the hose. The working pressure decreases with temperature – see derating factor. For rapid pressure fluctuations, consult the factory. Braid is T316 stainless steel. Monel braid is available upon request. When Monel braid is used, stated pressure ratings need to be reduced by 0.75. Part numbers for Monel braid are AF6780 (single braid), and AF6788 (double braid).

The specifications listed represent Hose Master LLC products only and do not represent any other manufacturer's products.



# INTERFLEX STRIPWOUND METAL HOSE

INTERFLEX (Roughbore) is Hose Master's high-quality, general-purpose hose, constructed from a single strip of metal that is profiled and locked onto itself. The interlocked, or overlapping, sections of strip are able to slide back and forth, providing the ability to flex.

INSIDE DIAMETER (IN)	IN 10 (GS,SS)		IN 15 (GS,SS,16,20)		IN 18 (GS,SS,16,20)		IN 25 (GS,SS,20)		IN 30 (GS,SS)		IN 20 AL	
	WT. PER FT. (LBS)	MIN. BEND RADIUS (IN.)	WT. PER FT. (LBS)	MIN. BEND RADIUS (IN.)	WT. PER FT. (LBS)	MIN. BEND RADIUS (IN.)	WT. PER FT. (LBS)	MIN. BEND RADIUS (IN.)	WT. PER FT. (LBS)	MIN. BEND RADIUS (IN.)	WT. PER FT. (LBS)	MIN. BEND RADIUS (IN.)
1 3/8			0.7	7	0.8	7						
1 1/2	0.5	6	0.7	6	0.9	6	1.3	7				
2*	0.7	8	1	8	1.1	8	1.7	9	2.0*	11		
2 1/2*	0.8	10	1.2	10	1.4	10	2.1	11	2.5*	13		
3	1	11	1.4	12	1.6	12	2.5	13	2.9	14	0.7	14
3 1/2	1.1	13	1.6	14	1.9	14	2.8	15	3.4	16	0.8	16
4	1.2	14	1.8	16	2.2	16	3.2	17	3.8	18	0.9	18
4 1/2	1.4	17	2	17	2.4	17	3.6	19	4.3	20	1	20
5	1.5	18	2.2	19	2.7	19	4	21	4.7	22	1.1	22
6	1.8	21	2.7	23	3.2	23	4.7	25	5.6	26	1.3	26
7			3.1	27	3.7	27	5.5	29	6.5	30	1.5	30
8			3.5	30	4.2	30	6.2	33	7.4	34	1.8	34
9			3.9	34	4.7	34	7	37	8.3	38	2	38
10			4.4	38	5.2	38	7.7	41	9.2	42	2.2	42
11					5.7	42	8.5	45	10.1	46	2.4	46
12					6.2	45	9.3	49	11	50	2.6	50
13					6.7	49	10	53	11.9	54	2.8	54
14					7.2	53	10.8	56	12.8	57	3	57
15					7.7	56	11.5	60	13.7	61	3.2	61
16					8.2	60	12.3	64	14.6	65	3.4	64

\*2" & 2 1/2" diameters: 30 available in Galvanize only.

**Notes:** Other diameters are available upon request. For packed hose, add 10% to both weight per foot and minimum bend radius. Minimum bend radius is measured from the centerline of the hose.

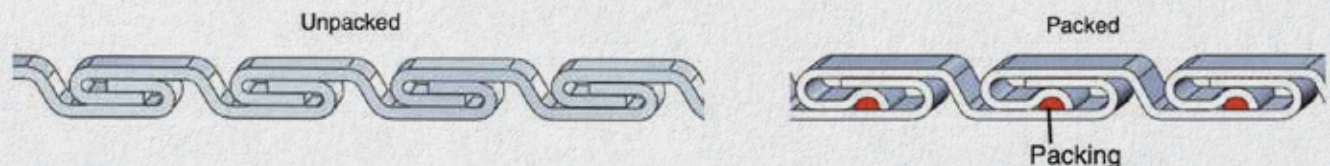

## AVAILABLE PACKINGS

PACKING TYPE	FEATURES	MAX TEMP.
Low-Temp Elastomeric	Max Pressure and Vacuum	200° F
High-Temp Elastomeric	Max Pressure and Vacuum	500° F
Low-temp Fiber	Economical	180° F
High-Temp Fiber	Elevated Temperature	1000° F
Metal	Extreme Temp.	800° F – 1200° F

## WHEN TO CONSIDER PACKING:

Interlocked metal hose, by the nature of its construction, is not pressure tight. However, pressure and media infiltration through the interlocked wall can be minimized by the insertion of one of a variety of packings into the wall during hose manufacturing. Packing consists of a continuous cord or strand of elastomer, or other material that is locked into a special channel between the interlocked hose-wall layers. The choice of packing material is tailored to the demands of the specific application.

The specifications listed represent Hose Master LLC products only and do not represent any other manufacturer's products.

\* RAGCO supports the autonomy of its locations to select the best products to service their markets. Subtle variations of these specifications may exist. Contact your RAGCO affiliate for confirmation.





# HOSE FITTINGS

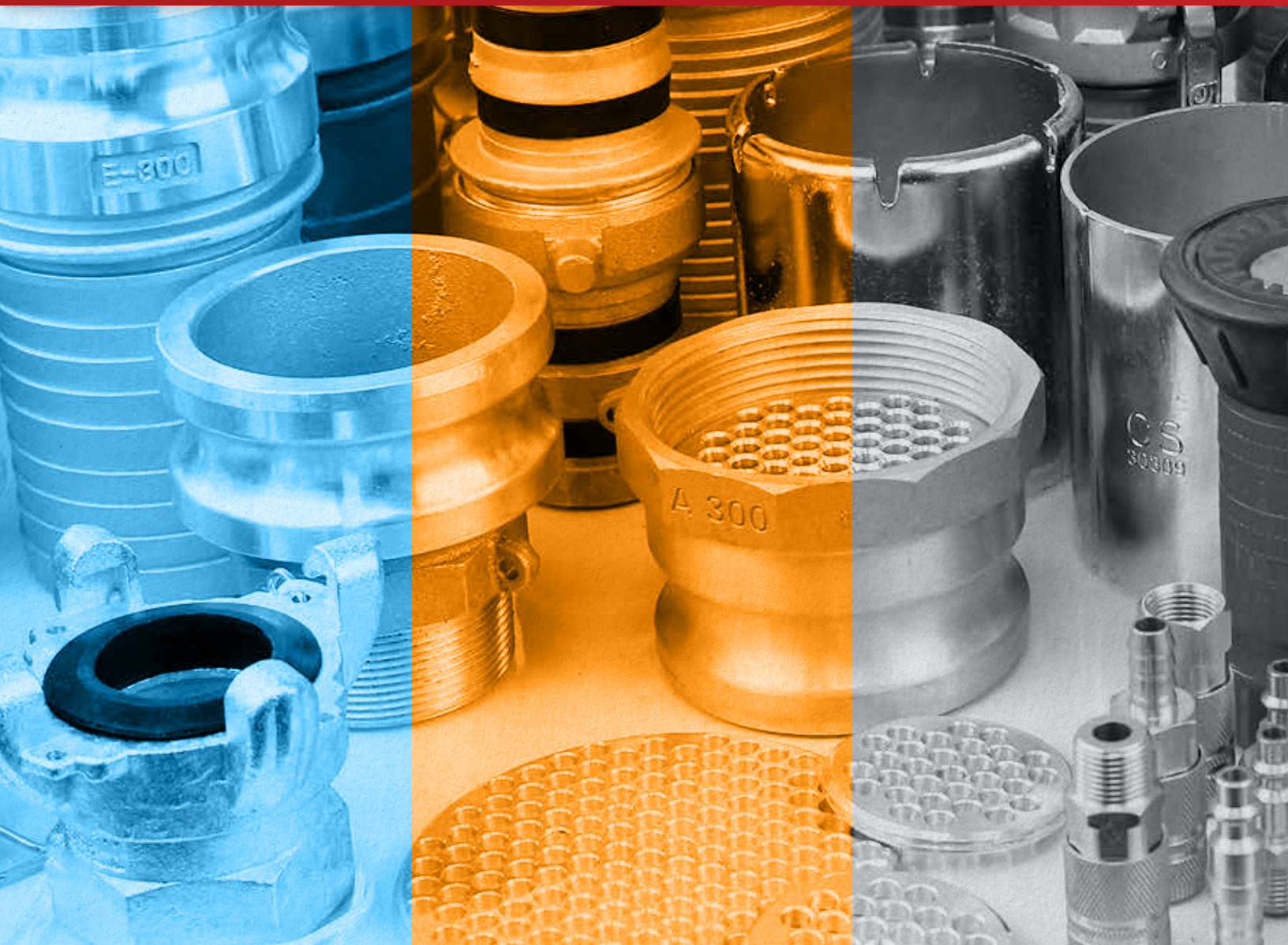



# CAM AND GROOVE FITTINGS

A cam and groove coupling, also called a "camlock" fitting, is a form of hose coupling popular because it is a simple and reliable means of connecting and disconnecting quickly and without tools.

The cams at the end of each lever on the female end align with a circumferential groove on the male end. When the levers are rotated to the locked position, they pull the male end into the female socket, creating a tight seal up against a gasket. The arms lock into position using an over-center arrangement, preventing accidental decoupling. Because the groove is cut all the way around the male end, there is no specific alignment necessary to couple as there would be with threaded connectors, and there is no opportunity for cross-threading. This results in an error-resistant, faster coupling operation. Because the compression between the two fittings is limited by the size of the cams on the end of the levers and the rotation of the levers themselves, there is also no possibility of over- or under-tightening the fitting; the pressure against the sealing gasket is effectively constant from one coupling operation to the next, reducing possibility of leaks.

Because there are no threads to become fouled, cam and groove couplings are popular in moderately dirty environments, such as septic tank pump trucks and chemical / fuel tanker trucks.

A cam and groove fitting can be used in a system where rapid filling of chemical drums takes place. It can be used by factories that have needs of dye, paint and ink medium transfers. It is used where frequent changes of hoses are required to find the right mix. It is also suitable for petroleum trucks, etc.

**Note:** Cam and groove couplings are not recommended for any type of compressed gas service, including steam.

## GENERAL SPEAKING, THE MOST COMMON TYPES OF CAM AND GROOVE COUPLING ARE THESE:

- **TYPE A:** adapter (male camlock) X female thread
- **TYPE B:** coupler (female camlock) X male thread
- **TYPE C:** coupler (female camlock) X shank
- **TYPE D:** coupler (female camlock) X female thread
- **TYPE E:** adapter (male camlock) X shank
- **TYPE F:** adapter (male camlock) X male thread
- **DUST CAP:** covers & seals adapter (male camlock) end
- **DUST PLUG:** covers & seals coupler (female camlock) end

Additional materials (hardcoat aluminum, carbon steel, food grade, nylon, and more) are also available. Additional configuration can be custom made. Please call regarding any item or spare part not seen here.

Parts denoted with an \* may be welded.

Drawings and pressure chart follow part listings.



## BASIC FITTINGS & DIMENSIONS PART A

### PART A - ADAPTER X FEMALE THREAD



#### GENERAL DIMENSIONS

REF	DESCRIPTION	E05	5	3/4"	1"	1 1/4"	1 1/2"	2"	2 1/2"	3"	4"	5"	6"	8"	10"	12"
	COUPLER OR ADAPTER SIZE	0.5	0.75	0.75	1	1.25	1.5	2	2.5	3	4	5	6	8	10	12
	THREAD SIZE	0.5	0.5	0.75	1	1.25	1.5	2	2.5	3	4	5	6	8	10	12
C	OVERALL LENGTH (in)	1.6	1.62	1.62	1.91	2.16	2.29-	2.54	2.75	2.84	3.16	3.22	3.35	4.5	4.5	4.38
E	INSIDE DIAMETER (in)	0.53	0.66	0.75	0.88	1.04	1.35-	1.72	2.14	2.8	3.78	4.79	5.99	7.8	10.1	12
F	ACROSS CORNERS (in)	1.12	1.49	1.49	1.76	2.19	2.44	2.92	3.49	4.22	5.41	6.49	7.7	10.23	12.79	14.75
G	CHAIN LUG EXTENSION (in)	N/A	N/A	N/A	0.34	0.34	0.33	0.31	0.27	0.44	0.39	0.35	0.6	0.6	0.6	0.6

#### STANDARD PARTS

SIZE	PART NAME	ALUMINUM ITEM #	BRASS ITEM #	STAINLESS STEEL ITEM #	POLYPROPYLENE ITEM #
1/2"	E05A	1000101	1200101	1400101	CALL
3/4" x 1/2"	1/2A	1000105	1200105	1400105	CALL
3/4"	07A	1000107	1200107	1400107	2700107
1"	10A	1000110	1200110	1400110	2700110
1 1/4"	12A	1000112	1200112	1400112	2700112
1 1/2"	15A	1000115	1200115	1400115	2700115
2"	20A	1000120	1200120	1400120	2700120
2 1/2"	25A	1000125	1200125	1400125	CALL
3"	30A	1000130	1200130	1400130	2700130
4"	40A	1000140	1200140	1400140	2700140
5"	50A	1000150	1200150	1400150	CALL
6"	60A	1000160	1200160	1400160	CALL
8"	80A	1000180	1200180	1400180	CALL
10"	100A	1000190	1200190	1400190	CALL
12"	120A	1000192	CALL	1400192	CALL

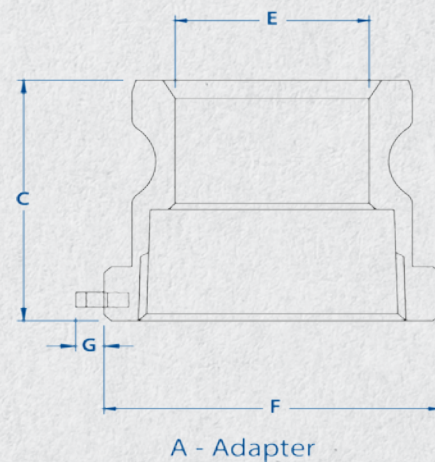

\* RAGCO supports the autonomy of its locations to select the best products to service their markets. Subtle variations of these specifications may exist. Contact your RAGCO affiliate for confirmation.



# CAM & GROOVE FITTINGS CONTINUED

## BASIC FITTINGS & DIMENSIONS PART B

### PART B - COUPLER X MALE THREAD



#### GENERAL DIMENSIONS

REF	DESCRIPTION	E05	5	3/4"	1"	1 1/4"	1 1/2"	2"	2 1/2"	3"	4"	5"	6"	8"	10"	12"
A	COUPLER OR ADAPTER SIZE	0.5	0.75	0.75	1	1.25	1.5	2	2.5	3	4	5	6	8	10	12
	THREAD SIZE	0.5	0.5	0.75	1	1.25	1.5	2	2.5	3	4	5	6	8	10	12
A	O.D. WITH CAM ARMS EXTENDED in	4.21	4.51	4.51	5.1	6.86	7.16	7.54	8.03	9.56	10.66	11.67	16.26	18.23	20.66	22.72
B	OUTSIDE DIAMETER in	1.82	2.11	2.11	2.44	3.26	3.56	3.94	4.43	5.46	6.56	7.57	10.16	12.13	14.56	16.62
C	OVERALL LENGTH in	2.1	2.1	2.1	2.5	2.89	2.93	3.2	3.63	3.82	4	4.2	4.52	4.8	5.5	5.7
D	EXPOSED LENGTH in	1.25	1.25	1.25	1.56	1.84	1.88	2.15	2.18	2.27	2.34	2.44	2.62	2.72	3.2	3.2
E	INSIDE DIAMETER in	0.56	0.56	0.78	0.97	1.25	1.5	1.88	2.38	2.88	3.6	4.5	5.6	7.5	9.4	11.4

#### STANDARD PARTS

		ALUMINUM/ STAINLESS HANDLES	ALUMINUM/ BRASS HANDLES	BRASS/ STAINLESS HANDLES	BRASS/ BRASS HANDLES	STAINLESS STEEL	POLYPROPYLENE
SIZE	PART NAME	ITEM #	ITEM #	ITEM #	ITEM #	ITEM #	ITEM #
1/2"	E05B	1000201	1070201	1290201	1200201	1400201	CALL
3/4" x 1/2"	1/2B	1000205	1070205	1290205	1200205	1400205	CALL
3/4"	07B	1000207	1070207	1290207	1200207	1400207	2700207
1"	10B	1000210	1070210	1290210	1200210	1400210	2700210
1 1/4"	12B	1000212	1070212	1290212	1200212	1400212	2700212
1 1/2"	15B	1000215	1070215	1290215	1200215	1400215	2700215
2"	20B	1000220	1070220	1290220	1200220	1400220	2700220
2 1/2"	25B	1000225	1070225	1290225	1200225	1400225	CALL
3"	30B	1000230	1070230	1290230	1200230	1400230	2700230
4"	40B	1000240	1070240	1290240	1200240	1400240	CALL
5"	50B	1000250	1070250	1290250	1200250	1400250	CALL
6"	60B	1000260	1070260	CALL	1200260	1400260	CALL
8"	80B	1000280	1070280	CALL	1200280	1400280	CALL
10"	100B	1000290	1070290	CALL	1200290	CALL	CALL
12"	120B	1000292	1070292	CALL	CALL	CALL	CALL

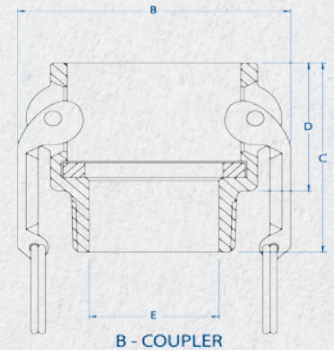



# CAM AND GROOVE FITTINGS CONTINUED

## BASIC FITTINGS & DIMENSIONS PART C

### PART C - COUPLER X HOSE SHANK



#### GENERAL DIMENSIONS

REF	DESCRIPTION	E05	5	3/4"	1"	1 1/4"	1 1/2"	2"	2 1/2"	3"	4"	5"	6"	8"	10"	12"
A	COUPLER OR ADAPTER SIZE	0.5	0.75	0.75	1	1.25	1.5	2	2.5	3	4	5	6	8	10	12
	HOSE SHANK SIZE	0.5	0.5	0.75	1	1.25	1.5	2	2.5	3	4	5	6	8	10	12
B	O.D. WITH CAM ARMS EXTENDED in	4.21	4.51	4.51	5.1	6.86	7.16	7.54	8.03	9.56	10.66	11.67	16.26	18.23	20.66	22.72
C	OUTSIDE DIAMETER in	1.82	2.11	2.11	2.44	3.26	3.56	3.94	4.43	5.46	6.56	7.57	10.16	12.13	14.56	16.62
D	OVERALL LENGTH in	2.69	2.7	3.55	4.06	4.44	4.82	5.53	5.93	6.32	6.64	7.24	9.5	9.5	12	12
E	EXPOSED LENGTH in	1.25	1.25	1.25	1.56	1.84	1.88	2.15	2.18	2.27	2.34	2.44	2.7	2.72	3.2	3.3
F	INSIDE DIAMETER in	0.38	0.38	0.53	0.78	0.97	1.22	1.71	2.16	2.65	3.53	4.53	5.53	7.53	9.4	11.4

#### STANDARD PARTS

		ALUMINUM/ STAINLESS STEEL HANDLES	ALUMINUM/ BRASS HANDLES	BRASS/ STAINLESS STEEL HANDLES	BRASS/ BRASS HANDLES	STAINLESS STEEL	POLYPROPYLENE
SIZE	PART NAME	ITEM #	ITEM #	ITEM #	ITEM #	ITEM #	ITEM #
1/2"	E05C	1000301	1070301	1290301	1200301	1400301	CALL
3/4" x 1/2"	1/2C	1000305	1070305	CALL	1200305	CALL	CALL
3/4"	07C	1000307	1070307	1290307	1200307	1400307	2700307
1"	10C	1000310	1070310	1290310	1200310	1400310	2700310
1 1/4"	12C	1000312	1070312	1290312	1200312	1400312	2700312
1 1/2"	15C	1000315	1070315	1290315	1200315	1400315	2700315
2"	20C	1000320	1070320	1290320	1200320	1400320	2700320
2 1/2"	25C	1000325	1070325	1290325	1200325	1400325	CALL
3"	30C	1000330	1070330	1290330	1200330	1400330	2700330
4"	40C	1000340	1070340	1290340	1200340	1400340	2700340
5"	50C	1000350	1070350	1290350	1200350	1400350	CALL
6"	60C	1000360	1070360	CALL	1200360	1400360	CALL
8"	80C	1000380	1070380	CALL	1200380	1400380	CALL
10"	100C	1000390	1070390	CALL	1200390	1400390	CALL
12"	120C	1000392	1070392	CALL	CALL	1400392	CALL

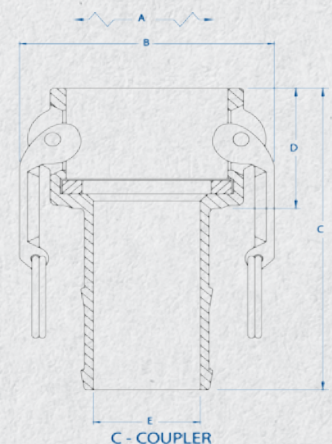

\* RAGCO supports the autonomy of its locations to select the best products to service their markets. Subtle variations of these specifications may exist. Contact your RAGCO affiliate for confirmation.



# CAM & GROOVE FITTINGS CONTINUED

## BASIC FITTINGS & DIMENSIONS PART D

### PART D - COUPLER X FEMALE THREAD



#### GENERAL DIMENSIONS

REF	DESCRIPTION	E05	5	3/4"	1"	1 1/4"	1 1/2"	2"	2 1/2"	3"	4"	5"	6"	8"	10"	12"
A	COUPLER OR ADAPTER SIZE	0.5	0.75	0.75	1	1.25	1.5	2	2.5	3	4	5	6	8	10	12
	THREAD SIZE	0.5	0.5	0.75	1	1.25	1.5	2	2.5	3	4	5	6	8	10	12
A	O.D. WITH CAM ARMS EXTENDED in	4.21	4.51	4.51	5.1	6.86	7.16	7.54	8.03	9.56	10.66	11.67	16.26	18.23	20.66	22.72
B	OUTSIDE DIAMETER in	1.82	2.11	2.11	2.44	3.26	3.56	3.94	4.43	5.46	6.56	7.57	10.16	12.13	14.56	16.62
C	OVERALL LENGTH in	2	2.1	2.1	2.5	2.7	2.8	3.1	3.4	3.5	3.9	4.1	4.4	4.8	5.5	5.7
E	INSIDE DIAMETER in	0.67	0.67	0.88	0.97	1.25	1.5	1.88	2.38	2.88	3.6	4.5	5.5	7.5	9.4	11.4

#### STANDARD PARTS

SIZE	PART NAME	ALUMINUM/ STAINLESS STEEL HANDLES	ALUMINUM/ BRASS HANDLES	BRASS/ STAINLESS STEEL HANDLES	BRASS/ BRASS HANDLES	STAINLESS STEEL	POLYPROPYLENE
SIZE	PART NAME	ITEM #	ITEM #	ITEM #	ITEM #	ITEM #	ITEM #
1/2"	E05D	1000401	1070401	1290401	1200401	1400401	CALL
3/4" x 1/2"	1/2D	1000405	1070405	1290405	1200405	1400405	CALL
3/4"	07D	1000407	1070407	1290407	1200407	1400407	2700407
1"	10D	1000410	1070410	1290410	1200410	1400410	2700410
1 1/4"	12D	1000412	1070412	1290412	1200412	1400412	2700412
1 1/2"	15D	1000415	1070415	1290415	1200415	1400415	2700415
2"	20D	1000420	1070420	1290420	1200420	1400420	2700420
2 1/2"	25D	1000425	1070425	1290425	1200425	1400425	CALL
3"	30D	1000430	1070430	1290430	1200430	1400430	2700430
4"	40D	1000440	1070440	1290440	1200440	1400440	CALL
5"	50D	1000450	1070450	1290450	1200450	1400450	CALL
6"	60D	1000460	1070460	CALL	1200460	1400460	CALL
8"	80D	1000480	1070480	CALL	1200480	1400480	CALL
10"	100D	1000490	1070490	CALL	1200490	1400490	CALL
12"	120D	1000492	1070492	CALL	CALL	1400492	CALL

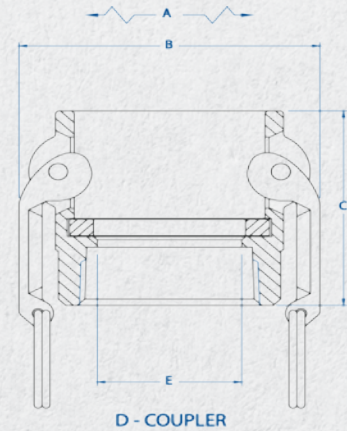

D - COUPLER



# CAM AND GROOVE FITTINGS CONTINUED

## BASIC FITTINGS & DIMENSIONS PART E

### PART E - ADAPTER X HOSE SHANK



#### GENERAL DIMENSIONS

REF	DESCRIPTION	E05	5	3/4"	1"	1 1/4"	1 1/2"	2"	2 1/2"	3"	4"	5"	6"	8"	10"	12"
	COUPLER OR ADAPTER SIZE	0.5	0.75	0.75	1	1.25	1.5	2	2.5	3.00)	4	5	6	8	10	12
	HOSE SHANK SIZE	0.5	0.5	0.75	1	1.25	1.5	2	2.5	3	4	5	6	8	10	12
B	OUTSIDE DIAMETER in	0.96	1.26	1.26	1.63	2	2.14	2.64	3.07	3.7	4.71	6.56	7.1	9.1	11.37	13.46
C	OVERALL LENGTH in	2.56	3.21	3.78	4.3	4.9	5.1	5.75	6.63	6.88	7.2	7.56	10.1	10.1	11.7	11.7
D	EXPOSED LENGTH in	1.11	1.46	1.46	1.8	2.36	2.15	2.4	2.47	2.53	2.6	2.81	3.3	3.3	2.88	2.88
E	INSIDE DIAMETER in	0.38	0.35	0.53	0.88	0.97	1.19	1.68	2.13	2.62	3.5	4.53	5.53	7.53	9.4	11.4

#### STANDARD PARTS

		ALUMINUM	BRASS	STAINLESS STEEL	POLYPROPYLENE
SIZE	PART NAME	ITEM #	ITEM #	ITEM #	ITEM #
1/2"	E05E	1000501	1200501	1400501	CALL
3/4" x 1/2"	1/2E	CALL	1200505	1400505	CALL
3/4"	07E	1000507	1200507	1400507	2700507
1"	10E	1000510	1200510	1400510	2700510
1 1/4"	12E	1000512	1200512	1400512	2700512
1 1/2"	15E	1000515	1200515	1400515	2700515
2"	20E	1000520	1200520	1400520	2700520
2 1/2"	25E	1000525	1200525	1400525	CALL
3"	30E	1000530	1200530	1400530	2700530
4"	40E	1000540	1200540	1400540	2700540
5"	50E	1000550	1200550	1400550	CALL
6"	60E	1000560	1200560	1400560	CALL
8"	80E	1000580	1200580	1400580	CALL
10"	100E	1000590	CALL	1400590	CALL
12"	120E	1000592	CALL	CALL	CALL

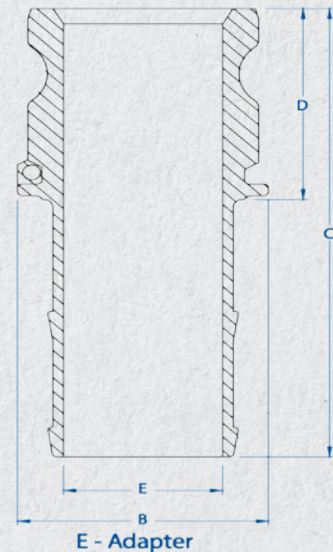

\* RAGCO supports the autonomy of its locations to select the best products to service their markets. Subtle variations of these specifications may exist. Contact your RAGCO affiliate for confirmation.



# CAM & GROOVE FITTINGS CONTINUED

## BASIC FITTINGS & DIMENSIONS PART F

### PART F - ADAPTER X MALE THREAD



#### GENERAL DIMENSIONS

REF	DESCRIPTION	E05	5	3/4"	1"	1 1/4"	1 1/2"	2"	2 1/2"	3"	4"	5"	6"	8"	10"	12"
C	COUPLER OR ADAPTER SIZE	0.5	0.75	0.75	1	1.25	1.5	2	2.5	3	4	5	6	8	10	12
	THREAD SIZE	0.5	0.5	0.75	1	1.25	1.5	2	2.5	3	4	5	6	8	10	12
D	OVERALL LENGTH in	1.96	2.47	2.47	2.89	3.23	3.29	3.57	4.18	4.37	4.79	4.91	5.2	5.9	6.75	7.2
E	EXPOSED LENGTH in	1.26	1.67	1.67	1.99	2.23	2.31	2.57	2.78	2.87	3.19	3.21	3.4	3.9	4.38	4.8
F	INSIDE DIAMETER in	0.53	0.56	0.75	0.85	1.04	1.34	1.72	2.14	2.8	3.78	4.79	5.84	7.8	9.88	12
G	MAX. ACROSS CORNERS in	1.12	1.42	1.42	1.75	2.16	2.44	2.84	3.45	4.07	5.27	6.39	7.7	10	11.87	14.1
	CHAIN LUG EXTENSION in	N/A	N/A	N/A	0.34	0.34	0.3	0.28	0.29	0.44	0.4	0.16	0.6	0.6	0.6	0.6

#### STANDARD PARTS

		ALUMINUM	BRASS	STAINLESS STEEL	POLYPROPYLENE
SIZE	PART NAME	ITEM #	ITEM #	ITEM #	ITEM #
1/2"	E05F	1000601	1200601	1400601	CALL
3/4" x 1/2"	1/2F	1000605	1200605	1400605	CALL
3/4"	07F	1000607	1200607	1400607	2700607
1"	10F	1000610	1200610	1400610	2700610
1 1/4"	12F	1000612	1200612	1400612	2700612
1 1/2"	15F	1000615	1200615	1400615	2700615
2"	20F	1000620	1200620	1400620	2700620
2 1/2"	25F	1000625	1200625	1400625	CALL
3"	30F	1000630	1200630	1400630	2700630
4"	40F	1000640	1200640	1400640	CALL
5"	50F	1000650	1200650	1400650	CALL
6"	60F	1000660	1200660	1400660	CALL
8"	80F	1000680	1200680	1400680	CALL
10"	100F	1000690	1200690	1400690	CALL
12"	120F	1000692	CALL	1400692	CALL

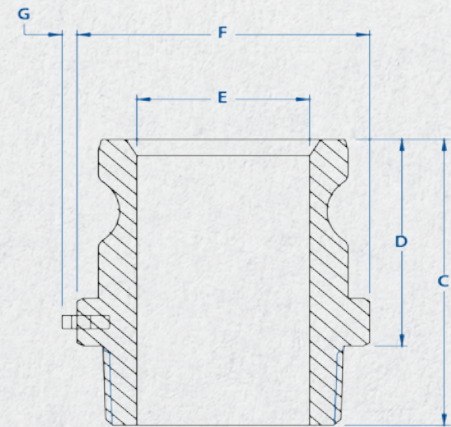

F - Adapter



# CAM AND GROOVE FITTINGS CONTINUED

## BASIC FITTINGS & DIMENSIONS PART V

### PART V - DUST CAP



### GENERAL DIMENSIONS

REF	DESCRIPTION	E05	5	3/4"	1"	1 1/4"	1 1/2"	2"	2 1/2"	3"	4"	5"	6"	8"	10"	12"
A	COUPLER OR ADAPTER SIZE	0.5	N/A	0.75	1	1.25	1.5	2	2.5	3	4	5	6	8	10	12
	O.D. WITH CAM ARMS EXTENDED in	4.21	N/A	4.51	5.1	6.86	7.16	7.54	8.03	9.56	10.66	11.67	16.26	18.23	20.66	22.72
B	OUTSIDE DIAMETER in	1.82	N/A	2.11	2.44	3.26	3.56	3.94	4.43	5.46	6.56	7.57	10.16	12.13	14.56	16.62
C	OVERALL LENGTH in	1.3	N/A	1.35	1.6	1.89	1.96	2.25	2.28	2.27	2.34	2.44	2.76	2.72	3.3	3.5
G	CHAIN LUG EXTENSION in	0.5	N/A	0.5	0.62	0.6	0.86	0.76	0.9	1.03	0.99	1.15	1.14	1.18	1.3	1.3

### STANDARD PARTS

SIZE	PART NAME	ALUMINUM/ STAINLESS STEEL HANDLES	ALUMINUM/ BRASS HANDLES	BRASS/ STAINLESS STEEL HANDLES	BRASS/ BRASS HANDLES	STAINLESS STEEL	POLYPROPYLENE
SIZE	PART NAME	ITEM #	ITEM #	ITEM #	ITEM #	ITEM #	ITEM #
1/2"	E05V	1001101	1071101	1291101	1201101	1401101	CALL
3/4"	07V	1001107	1071107	1291107	1201107	1401107	CALL
1"	10V	1001110	1071110	1291110	1201110	1401110	2701107
1 1/4"	12V	1001112	1071112	1291112	1201112	1401112	2701110
1 1/2"	15V	1001115	1071115	1291115	1201115	1401115	2701112
2"	20V	1001120	1071120	1291120	1201120	1401120	2701115
2 1/2"	25V	1001125	1071125	1291125	1201125	1401125	CALL
3"	30V	1001130	1071130	1291130	1201130	1401130	2701120
4"	40V	1001140	1071140	1291140	1201140	1401140	2701130
5"	50V	1001150	1071150	CALL	1201150	1401150	2701140
6"	60V	1001160	1071160	CALL	1201160	1401160	CALL
8"	80V	1001180	1071180	CALL	1201180	1401180	CALL
10"	100V	1001190	1071190	CALL	1201190	1401190	CALL
12"	120V	1001192	1071192	CALL	1201192	1401192	CALL
12"	120C	1000392	1070392	CALL	CALL	1400392	CALL

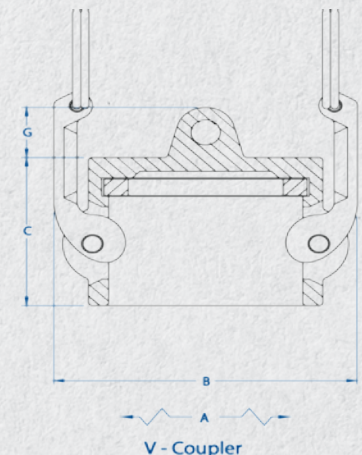

\* RAGCO supports the autonomy of its locations to select the best products to service their markets. Subtle variations of these specifications may exist. Contact your RAGCO affiliate for confirmation.



## BASIC FITTINGS & DIMENSIONS PART W

### PART W - DUST PLUG



### GENERAL DIMENSIONS

REF	DESCRIPTION	E05	5	3/4"	1"	1 1/4"	1 1/2"	2"	2 1/2"	3"	4"	5"	6"	8"	10"	12"
C	COUPLER OR ADAPTER SIZE	0.5	N/A	0.75	1	1.25	1.5	2	2.5	3	4	5	6	8	10	12
	OVERALL LENGTH in	1.06	N/A	1.41	1.35	1.94	2.06	1.9	2.44	2.03	2.1	2.63	2.28	2.28	3	2.88
G	CHAIN LUG EXTENSION in	0.5	N/A	0.59	0.96	0.62	0.5	0.7	0.81	1	1	0.85	1	1.18	0.9	0.5

### STANDARD PARTS

SIZE	PART NAME	ALUMINUM	BRASS	STAINLESS STEEL	POLYPROPYLENE
1/2"	E05W	1001201	1201201	1401201	CALL
3/4"	07W	1001207	1201207	1401207	CALL
1"	10W	1001210	1201210	1401210	2701207
1 1/4"	12W	1001212	1201212	1401212	2701210
1 1/2"	15W	1001215	1201215	1401215	2701212
2"	20W	1001220	1201220	1401220	2701215
2 1/2"	25W	1001225	1201225	1401225	CALL
3"	30W	1001230	1201230	1401230	2701220
4"	40W	1001240	1201240	1401240	2701230
5"	50W	1001250	1201250	1401250	2701240
6"	60W	1001260	1201260	1401260	CALL
8"	80W	1001280	1201280	1401280	CALL
10"	100W	1001290	1201290	1401290	CALL
12"	120W	1001292	CALL	CALL	CALL

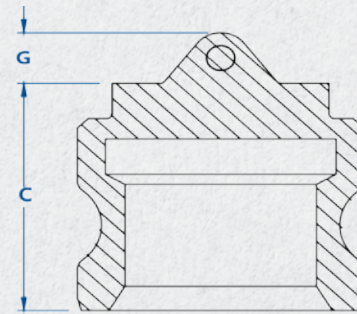

W - Adapter



## PRESSURE RATING CHART

MATERIAL	GASKET	SIZE	MAX. ALLOWABLE WORKING PRESSURE (PSI)
Metal	Standard gaskets are Buna; any variation must be specified	½", ¾ x ½", ¾", 1", 1¼", 1½", 2"	250
		2½", 3"	200
		4"	150
		5", 6"	75
		8", 10", 12"	50
Non-Metal	Standard gaskets are Buna; any variation must be specified	¾", 1", 1¼", 1½", 2"	100
		3", 4"	50

\* RAGCO supports the autonomy of its locations to select the best products to service their markets. Subtle variations of these specifications may exist. Contact your RAGCO affiliate for confirmation.



## 45- & 90-DEGREE FITTINGS

### 90-DEGREE PART A

ADAPTER X FEMALE NPT THREAD		ALUMINUM	BRASS	STAINLESS STEEL	POLYPROPYLENE
SIZE	PART NAME	ITEM #	ITEM #	ITEM #	ITEM #
1-1/4"	12LA	CALL	62491200	CALL	CALL
1-1/2"	15LA	60491500	62491500	CALL	67491500
2"	20LA	60492000	CALL	CALL	67492000
3"	30LA	60493000	CALL	64493000	CALL



### 45- & 90-DEGREE COUPLER X ADAPTER

COUPLER X ADAPTER		ALUMINUM/HBS	ALUMINUM/HB	BRASS	STAINLESS STEEL
SIZE	PART NAME	ITEM #	ITEM #	ITEM #	ITEM #
2"	20CAL - 90 Deg	60502120	CALL	62502120	64504120
3"	30CAL - 90 Deg	60503130	605000066	62503130	64503130
3"	30CAL - 45 Deg	6050313045	6050313046	62503131	64504130
4"	40CAL - 90 Deg	60504140	605000068	62504140	64504140
4"	40CAL - 45 Deg	60504145	60504147	62504141	64505153
8"	80CAL - 90 Deg	CALL	60504181H*	CALL	CALL



### 45- & 90-DEGREE COUPLER X COUPLER

COUPLER X COUPLER		ALUMINUM/STAINLESS STEEL HANDLES	ALUMINUM/BRASS HANDLES	BRASS	STAINLESS STEEL
SIZE	PART NAME	ITEM #	ITEM #	ITEM #	ITEM #
2"	20DDL - 90 Deg	60502220*	CALL	CALL	CALL
3"	30DDL - 90 Deg	60503230*	CALL	CALL	64503230
4"	40DDL - 90 Deg	60504240	605000069	62504240	64504240
4" x 3"	40X30DDL - 90 Deg	CALL	CALL	CALL	64504230
6" X 3"	60X30DDL-90 Deg	60506230*	CALL	CALL	64506260*
6"	60DDLHD - 90 Deg	60506260	CALL	CALL	CALL

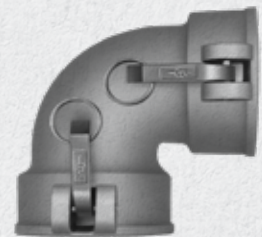



# CAM AND GROOVE FITTINGS CONTINUED

## 45- & 90-DEGREE FITTINGS CONTINUED

### 90-DEGREE PART C

COUPLER X HOSE SHANK		ALUMINUM/ STAINLESS STEEL HANDLES	ALUMINUM/ BRASS HANDLES	BRASS	STAINLESS STEEL	POLYPROPYLENE
SIZE	PART NAME	ITEM #	ITEM #	ITEM #	ITEM #	ITEM #
1"	10CL	60501000	6050000061	62501000	64501000	CALL
1-1/4"	12CL	60501200	6050000062	62501200	64501200	CALL
1-1/4" x 1-1/2"	12X15CL	CALL	CALL	62501215	CALL	CALL
1-1/2"	15CL	60501500	6050000063	62501500	64501500	67501500
2"	20CL	60502000	6050000064	62502000	64502000	67502000
2-1/2"	25CL	CALL	CALL	62502500	CALL	CALL
3"	30CL	60503000	6050000065	62503000	64503000	CALL
4"	40CL	60504000	6050000067	62504000	64504000	CALL
6"	60CL	CALL	60506000	62506000	64506000	CALL



### 45- & 90-DEGREE PART D

COUPLER X FEMALE NPT THREAD		ALUMINUM/ STAINLESS STEEL HANDLES	ALUMINUM/ BRASS HANDLES	BRASS	STAINLESS STEEL	POLYPROPYLENE
SIZE	PART NAME	ITEM #	ITEM #	ITEM #	ITEM #	ITEM #
1"	10LD	60481000	6048000062	62481000	64481000	CALL
1-1/4"	12LD	CALL	CALL	62481200	CALL	CALL
1-1/2"	15LD	60481500	6048000063	62481500	64481500	67481500
2"	20LD	60482000	6048000005	62482000	64482000	67482000
2-1/2"	25LD	60482500	6048000103	62482500	CALL	CALL
3"	30LD	60483000	6048000060	62483000	64483000	CALL
3" w/45°	30LD - 45 Deg	60483000SP	CALL	CALL	CALL	CALL
4"	40LD	60484000	6048000061	62484000	64484000	CALL
6"	60LD	60486000	CALL	62486000	64486000	CALL
10"	100LD	CALL	CALL	CALL	64481090	CALL

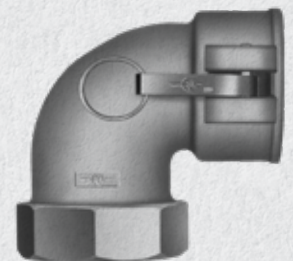

\* RAGCO supports the autonomy of its locations to select the best products to service their markets. Subtle variations of these specifications may exist. Contact your RAGCO affiliate for confirmation.



## REDUCER FITTINGS

### PART A REDUCER

		ALUMINUM	BRASS	STAINLESS STEEL
SIZE	PART NAME	ITEM #	ITEM #	ITEM #
3/4" x 1"	07X10A	60220710	CALL	CALL
1" x 1/2"	10X05A	CALL	CALL	64141001
1" x 1-1/2"	10X15A	60141015	CALL	64141015
1-1/2" x 1"	15X10A	60141510	62141510	64141510
1-1/2" x 1-1/4"	15X12A	CALL	62141512	64141512
1-1/2" x 2"	15X20A	60141520	62141520	64141520
2" x 1-1/4"	20X12A	60142012*	CALL	CALL
2" x 1-1/2"	20X15A	60142015	62142015	64142015
2" x 2-1/2"	20X25A	60142025	62142025	64142025
2" x 3"	20X30A	60142030	62142030	64142030
2" x 4"	20X40A	60142040*	CALL	64142040*
2-1/2" x 1-1/2"	25X15A	60142515	CALL	CALL
2-1/2" x 2"	25X20A	60142520	62142520	64142520
2-1/2" x 3"	25X30A	60142530	62142530	64142530
2-1/2" x 4"	25X40A	60142540	62142540	CALL
3" x 1"	30X10A	CALL	CALL	CALL
3" x 2"	30X20A	60143020	62143020	64143020
3" x 2-1/2"	30X25A	60143025	62143025	CALL
3" x 4"	30X40A	60143040	62143040	64143040
4" x 2"	40X20A	CALL	CALL	64144020*
4" x 2-1/2"	40X25A	60144025	62144025	CALL
4" x 3"	40X30A	60144030	62144030	64144030
4" x 5"	40X50A	60144050	CALL	64144050
5" x 3"	50X30A	60145030	CALL	64145030



### PART B REDUCER

		ALUMINUM	BRASS
SIZE	PART NAME	ITEM #	ITEM #
1" x 2"	10X20B	60181020	CALL
1-1/2" x 1"	15X10B	60181510	62181510
1-1/2" x 2"	15X20B	60181520	CALL
2" x 1"	20X10B	CALL	62182010
2" x 1-1/2"	20X15B	60182015	62182015
2" x 2-1/2"	20X25B	60182025*	CALL
2" x 3"	20X30B	60182030	CALL
2-1/2" x 2"	25X20B	60182520	62182520
2-1/2" x 3"	25X30B	60182530	CALL
3" x 2"	30X20B	60183020	62183020
3" x 2-1/2"	30X25B	60183025	62183025
3" x 4"	30X40B	60183040	62183040
4" x 2"	40X20B	60184020	CALL
4" x 2-1/2"	40X25B	60184025	62184025
4" x 3"	40X30B	60184030	62184030
5" x 3"	50X30B	60185030*	CALL
5" x 4"	50X40B	60185040*	CALL
8" x 6"	80X60B	60188060*	CALL
8" x 10"	80X100B	CALL	CALL
10" x 8"	100X80B	CALL	CALL

		STAINLESS STEEL
SIZE	PART NAME	ITEM #
1" x 3/4"	10X07B	64181007
1" x 1-1/2"	10X15B	64181015*
1" x 2"	10X20B	CALL
1-1/2" x 1"	15X10B	64181510*
2" x 1"	20X10B	64182010*
2" x 1-1/2"	20X15B	64182015
2" x 3"	20X30B	64182030*
2-1/2" x 2"	25X20B	64182520
2-1/2" x 3"	25X30B	64182530
3" x 2"	30X20B	64183020
3" x 2-1/2"	30X25B	64183025
3" x 4"	30X40B	64183040*
4" x 2"	40X20B	64184020*
4" x 3"	40X30B	64184030
5" x 3"	50X30B	CALL





# CAM AND GROOVE FITTINGS CONTINUED

## REDUCER FITTINGS CONTINUED

### PART C REDUCER

COUPLER X HOSE SHANK		ALUMINUM	BRASS
SIZE	PART NAME	ITEM #	ITEM #
1/2" x 3/4"	05X07C	CALL	62220107
1" x 3/4"	10X07C	CALL	CALL
1-1/4" x 1-1/2"	12X15C	CALL	62221215
1-1/2" x 1"	15X10C	60221510	62221510
1-1/2" x 2"	15X20C	60221520	62221520
2" x 1-1/2"	20X15C	60222015	62222015
2" x 2-1/2"	20X25C	60222025	62222025
2-1/2" x 1-1/2"	25X15C	60222515	CALL
2-1/2" x 2"	25X20C	60222520	CALL
3" x 1"	30X10C	60223010	CALL
3" x 1-1/2"	30X15C	60223015*	CALL
3" x 2"	30X20C	60223020	62223020
3" x 2-1/2"	30X25C	60223025	62223025
3" x 4"	30X40C	60223040*	CALL
3" x 5"	30X50C	60223050	CALL
4" x 2"	40X20C	60224020	62224020
4" x 2-1/2"	40X25C	60224025*	62224025
4" x 3"	40X30C	60224030	62224030
4" x 5"	40X50C	60224050	CALL
5" x 3"	50X30C	60225030*	CALL
5" x 4"	50X40C	60225040*	CALL
6" x 3"	60X30C	60226030	CALL
6" x 4"	60X40C	CALL	CALL
6" x 5"	60X50C	CALL	CALL
8" x 6"	80X60C	CALL	CALL
8" x 10"	80X100C	60228090*	CALL
10" x 8"	100X80C	60229080	CALL

COUPLER X HOSE SHANK		STAINLESS STEEL
SIZE	PART NAME	ITEM #
3/4" x 1/2"	07X05C	64220705
3/4" x 1"	07X10C	64220710
1" x 3/4"	10X07C	64221007*
1" x 1-1/2"	10X15C	64221015
1-1/2" x 1"	15X10C	64221510
1-1/2" x 2"	15X20C	64221520*
2" x 1"	20X10C	64222010*
2" x 1-1/2"	20X15C	64222015
2" x 2-1/2"	20X25C	64222025*
2-1/2" x 2"	25X20C	64222520*
3" x 2"	30X20C	64223020
3" x 2-1/2"	30X25C	64223025
3" x 4"	30X40C	64223040*
4" x 2"	40X20C	64224020*
4" x 3"	40X30C	64224030
4" x 5"	40X50C	64224050*
6" x 4"	60X40C	64226040
6" x 5"	60X50C	64226050*
8" x 6"	80X60C	64228060*

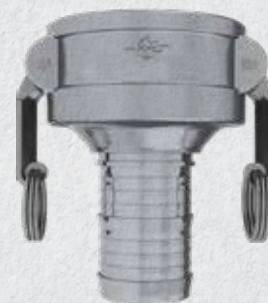

\* RAGCO supports the autonomy of its locations to select the best products to service their markets. Subtle variations of these specifications may exist. Contact your RAGCO affiliate for confirmation.



## REDUCER FITTINGS CONTINUED

### PART D REDUCER

COUPLER X FEMALE NPT THREAD		ALUMINUM/ HBS	BRASS	STAINLESS STEEL
SIZE	PART NAME	ITEM #	ITEM #	ITEM #
1-1/2" x 1"	15X10D	60201510	62201510	64201510
1-1/2" x 1-1/4"	15X12D	CALL	62201512	64201512
1-1/2" x 2"	15X20D	60201520	CALL	CALL
2" x 1"	20X10D	60202010*	CALL	CALL
2" x 1-1/2"	20X15D	60202015	62202015	64202015
2-1/2" x 1"	25X10D	60202510	CALL	CALL
2-1/2" x 2"	25X20D	60202520	62202520	64202520*
2-1/2" x 3"	25X30D	60202530	CALL	CALL
3" x 1"	30X10D	60203010*	CALL	CALL
3" x 2"	30X20D	60203020	62203020	64203020
3" x 2-1/2"	30X25D	60203025	62203025	64203025
3" x 4"	30X40D	60203040*	CALL	64203040*
4" x 3"	40X30D	60204030	62204030	64204030
5" x 4"	50X40D	60205040*	CALL	64205040*
8" x 6"	80X60D	CALL	CALL	CALL



### PART E REDUCER

ADAPTER X HOSE SHANK		ALUMINUM	BRASS	STAINLESS STEEL	HARD COAT ALUM
SIZE	PART NAME	ITEM #	ITEM #	ITEM #	ITEM #
1" x 1/2"	10X05E	CALL	CALL	64241005*	CALL
1" x 3/4"	10X07E	60241007	CALL	CALL	CALL
1" x 1-1/2"	10X15E	CALL	CALL	64241015	CALL
1-1/2" x 1"	15X10E	60241510	CALL	CALL	CALL
2" x 1"	20X10E	60242010*	CALL	CALL	CALL
2" x 1-1/2"	20X15E	60242015	62242015	64242015*	70242015
2" x 2-1/2"	20X25E	60242025	62242025	64242025*	CALL
3" x 2"	30X20E	60243020	62243020	64243020	70243020
3" x 2-1/2"	30X25E	60243025	62243025	64243025	CALL
4" x 3"	40X30E	60244030	62244030	64244030	70244030
4" x 5"	40X50E	60244050	CALL	CALL	CALL
5" x 4"	50X40E	60245040*	CALL	CALL	CALL
6" x 4"	60X40E	60246040*	CALL	64246040*	CALL
6" x 5"	60X50E	60246050*	CALL	CALL	CALL
8" x 6"	80X60E	60248060*	CALL	CALL	CALL
10" x 8"	100X80E	60249080*	CALL	CALL	CALL





# CAM AND GROOVE FITTINGS CONTINUED

## REDUCER FITTINGS CONTINUED

### PART F REDUCER

ADAPTER X MALE NPT THREAD		ALUMINUM	BRASS	STAINLESS STEEL
SIZE	PART NAME	ITEM #	ITEM #	ITEM #
1" x 3/4"	10X07F	CALL	62161007	64341007
1" x 1-1/2"	10X15F	60161015	62161015	CALL
1" x 2"	10X20F	60161020	62161020	64161020
1 1/4" x 1-1/2"	12X15F	60161215	CALL	CALL
1-1/2" x 1"	15X10F	60161510	62161510	64161510
1-1/2" x 1-1/4"	15X12F	CALL	62161512	64161512
1-1/2" x 2"	15X20F	60161520	62161520	64161520
2" x 1"	20X10F	CALL	CALL	64162010*
2" x 1-1/2"	20X15F	60162015	62162015	64162015
2" x 2-1/2"	20X25F	60162025	CALL	64162025*
2" x 3"	20X30F	60162030	62162030	64162030
2-1/2" x 3"	25X30F	60162530	62162530	64162530*
2-1/2" x 4"	25X40F	CALL	62162540	CALL
3" x 1-1/2"	30X15F	60163015	62163015	64163015
3" x 2"	30X20F	60163020	62163020	64163020
3" x 2-1/2"	30X25F	60163025	62163025	64163025*
3" x 4"	30X40F	60163040	62163040	64163040
4" x 2"	40X20F	60164020	62164020	64164020*
4" x 2-1/2"	40X25F	60164025	62164025	CALL
4" x 3"	40X30F	60164030	62164030	64164030
5" x 4"	50X40F	60165040	62165040	CALL



### COUPLER X ADAPTER REDUCER

COUPLER X ADAPTER		BRASS	STAINLESS STEEL
SIZE	PART NAME	ITEM #	ITEM #
3/4" X 2"	07CX20A LONG	CALL	64260720
1" x 3/4"	10CX07A LONG	CALL	64261007*
1" x 1-1/2"	10CX15A LONG	62261015	64261015*
1" x 2"	10CX20A LONG	CALL	64261020*
1" x 3"	10CX30A LONG	CALL	64261030*
1-1/2" X 1"	15CX10A LONG	62261510	64261510
1-1/2" x 2"	15CX20A LONG	62261520	64261520
1-1/2" x 3"	15CX30A LONG	CALL	64261530*
1-1/2" x 4"	15CX40A LONG	62261540	CALL
2" x 3/4"	20CX07A LONG	CALL	64262007*
2" x 1"	20CX10A LONG	62262010	CALL
2" x 1-1/4"	20CX12A LONG	CALL	64262012
2" x 1-1/2"	20CX15A LONG	62262015	64262015
2" x 2"	20CX20A LONG	CALL	64262020*
2" x 2-1/2"	20CX25A LONG	CALL	64262025*
2" x 3"	20CX30A LONG	62262030	64262030
2" x 4"	20CX40A LONG	CALL	64262040*
2-1/2" x 2"	25CX20A LONG	62262520	64262520*
2-1/2" x 3"	25CX30A LONG	CALL	64262530*
2-1/2" x 4"	25CX40A LONG	62262540	64262540*
3" x 1"	30CX10A LONG	CALL	64263010*
3" x 1-1/2"	30CX15A LONG	62263015	CALL
3" x 2"	30CX20A LONG	62263020G	64263020
3" x 2-1/2"	30CX25A LONG	62263025	CALL
3" x 4"	30CX40A LONG	62263040	64263040
3" x 6"	30CX60A LONG	CALL	CALL
4" x 2-1/2"	40CX25A LONG	62264025	CALL
4" x 3"	40CX30A LONG	62264030G	64264030
4" x 5"	40CX50A LONG	62264050	64264050*
4" x 6"	40CX60A LONG	CALL	64264060*
5" x 4"	50CX40A LONG	62265040	64265040
5" X 6"	50CX60A LONG	CALL	64265060*
6" x 1-1/2"	60CX15A LONG	CALL	CALL
6" x 2"	60CX20A LONG	CALL	64266020*
6" x 3"	60CX30A LONG	CALL	64266030*
6" x 4"	60CX40A LONG	CALL	64266040
6" x 5"	60CX50A LONG	CALL	64266050
8" x 4"	80CX40A LONG	CALL	64268040*
8" x 6"	80CX60A LONG	CALL	64268060*

\* RAGCO supports the autonomy of its locations to select the best products to service their markets. Subtle variations of these specifications may exist. Contact your RAGCO affiliate for confirmation.



## REDUCER FITTINGS CONTINUED

### COUPLER X ADAPTER REDUCER (CONTINUED)

COUPLER X ADAPTER	ALUMINUM	
SIZE	PART NAME	ITEM #
1" x 3/4"	10CX07A LONG	60261007*
1" x 1-1/2"	10CX15A LONG	60261015
1-1/4" x 1-1/2"	12CX15A LONG	60261215
1-1/4" x 2"	12CX20A LONG	60261220*
1-1/2" x 1"	15CX10A LONG	60261510
1-1/2" x 1-1/4"	15CX12A LONG	60261512*
1-1/2" x 2"	15CX20A LONG	60261520
1-1/2" x 2-1/2"	15CX25A LONG	60261525*
1-1/2" x 3"	15CX30A LONG	60261530
1-1/2" x 4"	15CX40A LONG	60261540*
2" x 3/4"	20CX07A LONG	60262007
2" x 1"	20CX10A LONG	60262010
2" x 1-1/4"	20CX12A LONG	60262012
2" x 1-1/2"	20CX15A LONG	60262015
2" x 2-1/2"	20CX25A LONG	60262025*
2" x 3"	20CX30A LONG	60262030
2" x 4"	20CX40A LONG	60262040
2-1/2" x 2"	25CX20A LONG	60262520
2-1/2" x 2-1/2"	25CX25A LONG	60262525
2-1/2" x 3"	25CX30A LONG	60262530*
2-1/2" x 4"	25CX40A LONG	60262540
3" x 1-1/2"	30CX15A LONG	60263015

COUPLER X ADAPTER	ALUMINUM	
SIZE	PART NAME	ITEM #
3" x 2"	30CX20A LONG	60263020G
6" x 3"	60CX30A LONG	CALL
6" x 4"	60CX40A LONG	CALL
6" x 5"	60CX50A LONG	CALL
6" x 8"	60CX80A LONG	60266080*
8" x 4"	80CX40A LONG	60268040*
8" x 6"	80CX60A LONG	60268060G*
12" x 6"	120CX60A LONG	CALL
3" x 2-1/2"	30CX25A LONG	60263025
3" x 4"	30CX40A LONG	60263040
3" x 5"	30CX50A LONG	60263050
3" x 6"	30CX60A LONG	60263060*
4" x 1-1/2"	40CX15A LONG	60264015
4" x 2"	40CX20A LONG	60264020G
4" x 2-1/2"	40CX25A LONG	60264025
4" x 3"	40CX30A LONG	CALL
4" x 4"	40CX40A LONG	60264040
4" x 5"	40CX50A LONG	60264050
4" x 6"	40CX60A LONG	60264060
5" x 4"	50CX40A LONG	60265040
5" X 6"	50CX60A LONG	60265060*
6" x 2"	60CX20A LONG	CALL





## REDUCER FITTINGS CONTINUED

### COUPLER X COUPLER

COUPLER X COUPLER		ALUMINUM	BRASS	STAINLESS STEEL
SIZE	PART NAME	ITEM #	ITEM #	ITEM #
1" x 1"	10CX10C	60271010	62271010	64271010
1-1/4" x 1-1/4"	12CX12C	60271212	CALL	64271220*
1-1/2" x 1-1/2"	15CX15C	60271515	62271515	64271515
2" x 1-1/2"	20CX15C	60272015*	CALL	64272015*
2" x 2"	20CX20C	60272020	62272020	64272020
2-1/2" x 2"	25CX20C	60272520*	CALL	CALL
2-1/2" x 2-1/2"	25CX25C	60272525	62272525	64272525*
3" x 2"	30CX20C	60273020	62273020	64273020
3" x 2-1/2"	30CX25C	60272530	CALL	64272530*
3" x 3"	30CX30C	60273030	62273030	64273030
4" x 2"	40CX20C	60274020	CALL	64274020
4" x 3"	40CX30C	60274030	62274030	64273040
4" x 4"	40CX40C	60274040	62274040	64274040
5" x 4"	50CX40C	60275040*	CALL	64275040*
5" x 5"	50CX50C	60275050*	CALL	CALL
6" x 2"	60CX20C	60276020*	CALL	CALL
6" x 4"	60CX40C	60276040*	CALL	CALL
6" x 5"	60CX50C	60276050*	CALL	CALL
8" x 4"	80CX40C	60278040*	CALL	CALL
8" x 6"	80CX60C	60278060	CALL	CALL
8" x 8"	80CX80C	60278080	CALL	CALL



\* RAGCO supports the autonomy of its locations to select the best products to service their markets. Subtle variations of these specifications may exist. Contact your RAGCO affiliate for confirmation.



## REDUCER FITTINGS CONTINUED

### SA SPOOL ADAPTER - ADAPTER X ADAPTER

ADAPTER X ADAPTER		ALUMINUM	BRASS	STAINLESS STEEL	DUCTILE IRON	HARD COAT ALUM
SIZE	PART NAME	ITEM #	ITEM #	ITEM #	ITEM #	ITEM #
1/2" x 1/2"	SAE05XE05	60280101	62280101	64280101	CALL	CALL
3/4" x 3/4"	SA07X07	60280707	62280707	64280707	CALL	70280707
1" x 3/4"	SA10X07	60281007	62281007	CALL	CALL	CALL
1" x 1"	SA10X10	60281010	62281010	64281010	68281010	70281010
1" x 1 1/2"	SA10X15	60281015	62281015	64281015*	CALL	70281015
1" x 2"	SA10X20	CALL	62281020	64281020*	CALL	CALL
1" x 3"	SA10X30	CALL	62281030	CALL	CALL	CALL
1-1/4" x 1-1/4"	SA12X12	60281212	62281212	64281212	CALL	70281212
1-1/4" x 1-1/2"	SA12X15	60281215	62281215	64281215	CALL	CALL
1-1/2" x 1-1/2"	SA15X15	60281515	62281515	64281515	68281515	70281515
1-1/2" x 2"	SA15X20	60281520	62281520	64281520	68281520	70281520
1-1/2" x 4"	SA15X40	60281540	62281540	CALL	CALL	CALL
2" x 3/4"	SA20X07	60282007	CALL	CALL	CALL	CALL
2" x 2"	SA20X20	60282020	62282020	64282020	68282020	70282020
2" x 2-1/2"	SA20X25	60282025	62282025	CALL	CALL	70282025
2" x 3"	SA20X30	60282030	62282030	64282030	68282030	70282030
2-1/2" x 2"	SA25X20	CALL	CALL	64282520*	CALL	CALL
2-1/2" x 2-1/2"	SA25X25	60282525	62282525	64282525	68282525	CALL
2-1/2" x 3"	SA25X30	60282530	62282530	64282530	68282530	70282530
3" x 1-1/2"	SA30X15	60283015	62283015	64283015*	CALL	70283015
3" x 3"	SA30X30	60283030	62283030	64283030	68283030	70283030
3" x 4"	SA30X40	60283040	62283040	64283040	68283040	70283040
4" x 2"	SA40X20	60284020	62284020	64284020	CALL	70284020
4" x 4"	SA40X40	60284040	62284040	64284040	68284040	70284040
5" x 4"	SA50X40	60285040	CALL	64285040*	68285040	CALL
5" x 5"	SA50X50	60285050	62285050	64285050	68285050	CALL
6" x 3"	SA60X30	60286030	CALL	64286030*	CALL	70286030
6" x 4"	SA60X40	60286040	62286040	64284060*	68286040	70286040
6" x 5"	SA60X50	60286050*	CALL	CALL	CALL	CALL
6" x 6"	SA60X60	60286060	62286060	64286060*	CALL	70286060
6" x 8"	SA60X80	60286080*	CALL	CALL	CALL	CALL
8" x 4"	SA80X40	60288040*	CALL	CALL	CALL	CALL
10" x 6"	SA100X60	60289060*	CALL	CALL	CALL	CALL
10" x 8"	SA100X80	60289080*	CALL	CALL	CALL	CALL





## Y & T FITTINGS

### COUPLER X ADAPTER X ADAPTER "Y" FITTING

		ALUMINUM	BRASS	STAINLESS STEEL
SIZE	PART NAME	ITEM #	ITEM #	ITEM #
2"	20CX20AY	60592020	62592020	64592020
3" x 2"	30CX20AY	CALL	CALL	64593020*
3"	30CX30AY	CALL	CALL	64593030*
4"	40CX40AY	60594040*	CALL	CALL
6"	60CX60AYHD	60596060	CALL	CALL
6" x 6" x 4"	60CX60AX40AYHD	60596064	CALL	CALL

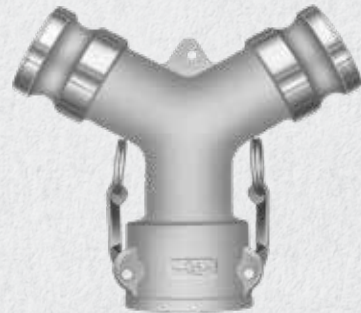

### COUPLER X COUPLER X ADAPTER "Y" FITTING

		ALUMINUM	BRASS
SIZE	PART NAME	ITEM #	ITEM #
2"	20AX20CY	60312020	62312020
4"	40AX40CY	60594140	CALL
6" x 4"	60AX40CYHD	60596041	CALL
6"	60AX60CYHD	60596061	CALL

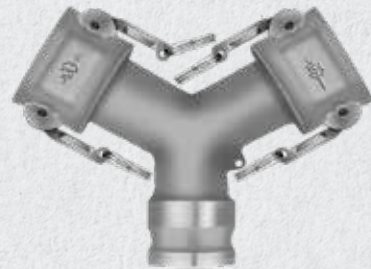

### COUPLER X ADAPTER X ADAPTER "T" FITTING

		ALUMINUM
SIZE	PART NAME	ITEM #
1-1/2"	15AX15AX15CT	60591515
2"	2AX20AX20CT	CALL
3"	30AX30AX30CT	CALL

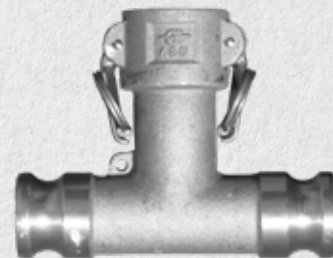

\* RAGCO supports the autonomy of its locations to select the best products to service their markets. Subtle variations of these specifications may exist. Contact your RAGCO affiliate for confirmation.



## FITTING X FLANGE

### COUPLER X FLANGE

		ALUMINUM/ BRASS HANDLES	ALUMINUM/ STAINLESS STEEL HANDLES	BRASS	STAINLESS STEEL
SIZE	PART NAME	ITEM #	ITEM #	ITEM #	ITEM #
3/4" X 1"	PF07X10C	CALL	CALL	CALL	64540710
1"	PF10C*	CALL	60541000*	CALL	64541000
1-1/2"	PF15C	CALL	60541500	62541500	64541500
1-1/2" X 2"	PF15X20C	CALL	CALL	CALL	64541520
2"	PF20C	6054000070	60542000	62542000	64542000
2" X 3"	PF20X30C	CALL	CALL	CALL	64542030*
2-1/2"	PF25C	CALL	60542500	62542500	64542500*
2-1/2" X 3"	PF25X30C	CALL	CALL	62542530	CALL
2-1/2" X 4"	PF25X40C	CALL	CALL	62542540	64542540
3"	PF30C	6054000071	60543000	62543000	64543000
3" x 2"	PF30X20C	CALL	CALL	CALL	64543020*
3" x 4"	PF30X40C	CALL	CALL	CALL	64543040*
3" x 6"	PF30X60C	60543060*	CALL	CALL	CALL
4"	PF40C	6054000072	60544000	62544000	64544000
4" x 3"	PF40X30C	6054030	CALL	CALL	CALL
4" x 6"	PF40X60C	6054060	6054060	CALL	CALL
5"	PF50C	CALL	60545000*	CALL	64545000
6"	PF60C	60546000	CALL	62546000	64546000
6" x 8"	PF60X80C	CALL	CALL	CALL	CALL
8"	PF80C	6054000073	60548000	62548000	64548000
8" x 12"	PF80X120C	605408092	CALL	CALL	CALL
10"	PF100C	60549000	CALL	CALL	64549000
12"	PF120C	60549200	60549201	CALL	CALL





## FITTING X FLANGE CONTINUED

### ADAPTER X FLANGE

		ALUMINUM	BRASS	STAINLESS STEEL
SIZE	PART NAME	ITEM #	ITEM #	ITEM #
3/4"	PF07A	CALL	CALL	64520700*
1"	PF10A	60521000	CALL	64521000
1" x 2"	PF10X20A	CALL	CALL	64521020
1-1/4" X 1-1/2"	PF12X25A	CALL	CALL	64521215*
1-1/2"	PF15A	60521500	62521500	64521500
1-1/2" x 2"	PF15X20A	CALL	CALL	64521520*
1-1/2" x 3"	PF15X30A	CALL	CALL	64521530*
2"	PF20A	60522000	62522000	64522000
2" x 1-1/2"	PF20X15A	CALL	CALL	64522015*
2" x 2-1/2"	PF20X25A	CALL	CALL	64522025
2" x 3"	PF20X30A	CALL	CALL	64522030*
2" x 4"	PF20X40A	CALL	CALL	64522040
2-1/2"	PF25A	60522500	62522500	64522500
2-1/2" x 4"	PF25X40A	60522540	CALL	64522540
3"	PF30A	60523000	62523000	64523000
3" x 2"	PF30X20A	CALL	CALL	64523020
3" x 4"	PF30X40A	60523040	62523040	64523040*
3" x 6"	PF30X60A	60523060*	CALL	CALL
4"	PF40A	60524009	62524000	64524000
4" x 3"	PF40x30A	60524030	CALL	64524030*
4" x 6"	PF40X60A	60524060	CALL	64524060
4" x 8"	PF40X80A	60524080	CALL	CALL
5"	PF50A	60525000	62525000	64525000
6"	PF60A	60526000	62526000	64526000
6" x 8"	PF60X80A	60526080	CALL	CALL
8"	PF80A	60528000	62528000	64528000
8" x 4"	PF80X40A	60528040*	CALL	CALL
10"	PF100A	60529000	62529000	64529000
10" x 12"	PF100X120A	CALL	CALL	64529092*
12"	PF120A	60529200	62529200	64529200



\* RAGCO supports the autonomy of its locations to select the best products to service their markets. Subtle variations of these specifications may exist. Contact your RAGCO affiliate for confirmation.



## FITTING ACCESSORIES

### SECURITY CHAINS

		SS CHAIN W/SS HOOKS	SS CHAIN W/SS RINGS
LENGTH	PART NAME	ITEM #	ITEM #
6"	S56	5101060A	5101061A
8"	S51	5101080A	5101081A
12"	S52	5101092A	5101093A

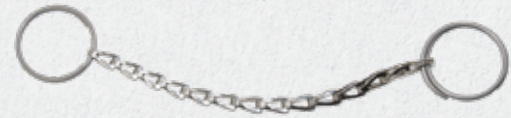

		BRASS CHAIN W/SS HOOKS	BRASS CHAIN W/ZINC RINGS
LENGTH	PART NAME	ITEM #	ITEM #
6"	C51	5100560A	5100560B
12"	C52	5100592A	5105592A



### STANDARD CAM ARM SETS

		BRASS		300 SERIES STAINLESS STEEL	
COUPLER SIZE	PART NAME	ITEM #	PART NAME	ITEM #	ITEM #
1/2 & 3/4"	HB10	5000505S	HBS10	5001505S	5001505S
1"	HB11	5000510S	HBS11	5001510S	5001510S
1-1/4"	HB12	5000512S	HBS12	5001512S	5001512S
1-1/2"	HB15	5000515S	HBS15	5001515S	5001515S
2 & 2-1/2"	HB20/25	5000520S	HBS20/25	5001520S	5001520S
3, 4, & 5"	HB30/40/50	5000530S	HBS30/40/50	5001530S	5001530S
6, 8, 10 & 12"	HB60/80	5000560S	HBS60/80	CALL	CALL



### CAM ARM RINGS

	STAINLESS STEEL	ZINC PLATED STEEL	BRASS CHAIN W/ ZINC RINGS
SIZE	ITEM #	ITEM #	ITEM #
1/2" - 2-1/2" Small Rings	5201005	5201505	5100560B
3" - 12" Large Rings	5201030	5201530	5105592A





## CAMLOCK GASKETS

### REPLACEMENT GASKETS

	STANDARD BUNA		EXTRA FUEL RESISTANT BUNA		NEOPRENE		VITON		SILICONE	
SIZE	PART NAME	ITEM #	PART NAME	ITEM #	PART NAME	ITEM #	PART NAME	ITEM #	PART NAME	ITEM #
1/2"	B05Y	5500205	CALL	CALL	N05Y	5500405	V05Y	5500805	S05Y	5502205
3/4"	B01	5500207	B01F	5500207F	N01	5500407	V01	5500807	S01	5502207
1"	B02	5500210	B02F	5500210F	N02	5500410	V02	5500810	S02	5502210
1-1/4"	B03	5500212	B03F	5500212F	N03	5500412	V03	5500812	S03	5502212
1-1/2"	B04	5500215	B04F	5500215F	N04	5500415	V04	5500815	S04	5502215
2"	B05	5500220	B05F	5500220F	N05Y	5500420	V05Y	5500820	S05	5502220
2-1/2"	B06	5500225	B06F	5500225F	N06	5500425	V06	5500825	S06	5502225
3"	B07	5500230	B07F	5500230F	N07	5500430	V07	5500830	S07	5502230
4"	B08	5500240	B08F	5500240F	N08	5500440	V08	5500840	S08	5502240
5"	B09	5500250	B09F	5500250F	N09	5500450	V09	5500850	S011	5502280
6"	B010	5500260	B010F	5500260F	N010	5500460	V010	5500860	CALL	CALL
8"	B011	5500280	CALL	CALL	N011	5500480	V011	5500880	CALL	CALL
10"	B012	5500290	CALL	CALL	CALL	CALL	V012	5500890	CALL	CALL
12"	B013	5500292	CALL	CALL	CALL	CALL	CALL	CALL	CALL	CALL

Other materials including silicone, PTFE enveloped, EPDM, food grade, etc. are available. Contact your Ragco location for more info.





# PIN-LUG COUPLINGS

Also called "suction hose couplings," these are threaded couplings used for suction or discharge of water or other fluids. Standard threading is NPSM (National Pipe Straight Mechanical). 1-1/2" and 2-1/2" are available in NST thread (American National Fire Hose Straight Thread). NST does not interchange. Pin lugs are on all sizes of the female end. Sizes 2-1/2" through 6" also have pin lugs on the male end. Fittings seal on a washer that sits in the female end. Replacement washers are available.

## PIN-LUG COUPLING SETS

SIZE	THREAD	ALUMINUM W/ BRASS SWIVEL	BRASS W/ BRASS SWIVEL
1 1/2"	NPSM	AB150	BR150
1 1/2"	NST	AB150NST	BR150NST
2"	NPSM	AB200	BR200
2 1/2"	NPSM	AB250	BR250
2 1/2"	NST	AB250NST	BR250NST
3"	NPSM	AB300	BR300
4"	NPSM	AB400	BR400
6"	NPSM	AB600	BR600



## WASHERS FOR PIN LUGS

SIZE	PART #
1 1/2"	RW150
1 1/2" NST	RW150NST
2"	RW200
2 1/2"	RW250
2 1/2" NST	RW250NST
3"	RW300
4"	RW400
6"	RW600





# COMBINATION HOSE NIPPLES

Combination hose nipples are used in a variety of fluid applications. They are available in unplated steel, plated steel, polypropylene, and stainless steel. End (male) threads are NPT (will mate with foot valves, strainers, cam- and-groove part A, D etc.) and are the same size as shanks. Jump sizes and reducers are also available.

## PLATED



## POLYPROPYLENE



## STAINLESS



SIZE	UNPLATED STEEL PART #	PLATED STEEL PART #	STAINLESS STEEL PART #	POLYPROPYLENE PART #
1/2"	CN050	CN050P	CN050S	CN050PP
3/4"	CN075	CN075P	CN075S	CN075PP
1"	CN100	CN100P	CN100S	CN100PP
1 1/4"	CN125	CN125P	CN125S	CN125PP
1 1/2"	CN150	CN150P	CN150S	CN150PP
2"	CN200	CN200P	CN200S	CN200PP
2 1/2"	CN250	CN250P	CN250S	CN250PP
3"	CN300	CN300P	CN300S	CN300PP
4"	CN400	CN400P	CN400S	CN400PP
5"	CN500	CN500P	CN500S	CN500PP
6"	CN600	CN600P	CN600S	CN600PP
8"	CN800	CN800P	CN800S	CN800PP
10"	CN1000	CN1000P	CN1000S	CN1000PP
12"	CN1200	CN1200P	CN1200S	CN1200PP

\* RAGCO supports the autonomy of its locations to select the best products to service their markets. Subtle variations of these specifications may exist. Contact your RAGCO affiliate for confirmation.



# UNIVERSAL AIR COUPLINGS 2-LUG & 4-LUG

Also called "Chicago," "CP," or "Crow's Foot" couplings. Used to connect air lines from compressors or other air sources to all types of pneumatic tools and equipment. All 2-lug head connections are of one size for easy interchange. Hose shank or threaded end is coupling size. Male and female threads are NPT. Malleable iron plated. (European style universals are available by special order.) Universal crowfoot couplings are recommended to be used in the transfer of air and/or water.

**2-LUG FEMALE END**



**4-LUG FEMALE END**



**2-LUG DEAD END**



**3-WAY CONNECTOR**



**2-LUG HOSE END**



**4-LUG HOSE END**



**2-LUG MALE DEAD END**



**WASHERS UG2 & UG4**



The application should be in an open system where the air or water is in motion (dynamic) and not in a closed, pressurized (static) condition. This dynamic application involves continuous flow; therefore, back pressure would be relieved by the very nature of the application. The applicable system should contain pressure relief valves to relieve any excess pressure. Safety clips and safety cables should be installed on either side of the coupling connection. The rated, maximum working pressure of Universal Crowfoot Air Hose Couplings is 150 psi (at ambient temperature - 70°F) for all parts. Standard parts are iron; parts are available made of other metals.

**2-lug:** for connections ¼" - 1"

**4-lug:** for connections 1 ¼" - 2"

**WARNING:** Universal Air Hose Couplings should NEVER be used for steam service.

## MALE END

MALE END SIZE	LUG	PART #
1/4"	2	ME-25
3/8"	2	ME-38
1/2"	2	ME-50
3/4"	2	ME-75
1"	2	ME-100
1 1/4"	4	-
1 1/2"	4	-
2"	4	-

## FEMALE END

MALE END SIZE	LUG	PART #
1/4"	2	FE-25
3/8"	2	FE-38
1/2"	2	FE-50
3/4"	2	FE-75
1"	2	FE-100
1 1/4"	4	FE-125
1 1/2"	4	FE-150
2"	4	FE-200

## HOSE END

HOSE END SIZE	LUG	PART #
1/4"	2	HE-25
3/8"	2	HE-38
1/2"	2	HE-50
3/4"	2	HE-75
1"	2	HE-100
1 1/4"	4	HE-125
1 1/2"	4	HE-150
2"	4	HE-200

## ACCESSORIES

ACCESSORIES	PART #
Washer for 2-Lug	UG2
Washer for 4-Lug	UG4
3-Way Connector	TWC
Dead End	BEC
Safety Pin & Lanyard	SPL



# GROUND JOINT COUPLINGS

An all-purpose coupling, the female ground joint consists of a **MALE STEM**, **WING NUT** and **FEMALE SPUD**. The female spud has NPT threads to accept the NPT threads of a rigid connection or male NPT nipple. Widely used for air, water or steam, the ground joint is secured with an interlocking clamp or ferrule. By replacing the female spud of a ground joint coupling with a double or male spud, hose-to-hose ground joint connections or hose-to-rigid connections are simplified. Double spuds for hose-to-hose connections are threaded **NPS MALE X NPS MALE**. (GJ wing nut is also NPS). For hose-to-rigid connection, the male spud is threaded **NPS MALE X NPT MALE**.

## FEMALE SPUD



SIZE	PART #
1/2"	GFS050
3/4"	GFS075
1"	GFS100
1 1/4"	GFS125
1 1/2"	GFS150
2"	GFS200
2 1/2"	GFS250
3"	GFS300
4"	GFS400

## MALE SPUD



SIZE	PART #
1/2"	GMS050
3/4"	GMS075
1"	GMS100
1 1/4"	GMS125
1 1/2"	GMS150
2"	GMS200
2 1/2"	GMS250
3"	GMS300
4"	GMS400

## DOUBLE SPUD



SIZE	PART #
1/2"	GDS050
3/4"	GDS075
1"	GDS100
1 1/4"	GDS125
1 1/2"	GDS150
2"	GDS200
2 1/2"	GDS250
3"	GDS300
4"	GDS400

## FEMALE GROUND JOINT



SIZE	PART #
1/2"	GJF050
3/4"	GJF075
1"	GJF100
1 1/4"	GJF125
1 1/2"	GJF150
2"	GJF200
2 1/2"	GJF250
3"	GJF300
4"	GJF400

## MALE STEM HEX HOSE NIPPLES

For air or many other applications, MS nipples are economical and reusable. The MS nipple accepts bands or clamps. However, each MS is especially designed with a collar behind the hex to engage the gripping fingers of an interlocking clamp. MS threads are NPT. Steel plated. Use also as companion end of female ground joint.

HOSE SIZE	THREAD SIZE	PART #
1/4"	1/4"	MS4-4
1/4"	3/8"	MS4-6
3/8"	1/4"	MS6-4
3/8"	3/8"	MS6-6
3/8"	1/2"	MS6-8
1/2"	1/4"	MS8-4
1/2"	3/8"	MS8-6
1/2"	1/2"	MS8-8
1/2"	3/4"	MS8-12
3/4"	1/2"	MS12-8

HOSE SIZE	THREAD SIZE	PART #
3/4"	3/4"	MS12-12
3/4"	1"	MS12-16
1"	3/4"	MS16-12
1"	1"	MS-16-16
1 1/4"	1 1/4"	MS20-20
1 1/2"	1 1/2"	MS24-24
2"	2"	MS32-32
2 1/2"	2 1/2"	MS40-40
3"	3"	MS48-48
4"	4"	MS64-64



\* RAGCO supports the autonomy of its locations to select the best products to service their markets. Subtle variations of these specifications may exist. Contact your RAGCO affiliate for confirmation.



# SANDBLAST COUPLINGS

There are three active sandblast system couplings: **NOZZLE HOLDERS** that accept the male threaded end of a sandblast nozzle, the **THREADED POT END** that is connected to the combination air and abrasive mix from the sandblast pot, and **HOSE ENDS** that are used to make hose-to-hose connections or hose-to-blast pot connections. All three are available in aluminum or brass. Hose ends are also available in iron.

## NOZZLE HOLDERS

Nozzle Holders are sleeve type couplings, secured to the hose with wood screws and have the same features as the sandblast hose end. The exception is that the end of the nozzle holder is NPT threaded to accept the sandblasting nozzle.

SIZE	ALUMINUM	BRASS
3/4"	NH1A	MH1B
1"	NH2A	NH2B
1 1/4"	NH3A	NH3B
1 1/2"	NH4A	NH4B



## THREADED POT ENDS

Threaded Pot Ends do not fit the hose, but rather are threaded (NPT or NPS) onto the sandblast pot. Once properly threaded to the discharge pipe on the pot, the 2-lug crowfoot design can now be connected to the 2-lug crowfoot design of the hose end. Now the pot can supply mix to the operator by way of the hose to the sandblast nozzle.

SIZE	TYPE	ALUMINUM	BRASS
1 1/4"	NPT	SB1A	SB1B
1 1/4"	NPS	SB10A	SB10B
1 1/2"	NPT	SB2A	SB2B
1 1/2"	NPS	SB20A	SB20B



## HOSE ENDS

Hose Ends are sleeve type couplings that fit over the OD of the sandblast hose. They are secured to the hose with wood screws. Countersunk holes on the hose end ensure that the screws fit correctly and will not be snagged while the hose is in operation. Within the ID of the hose end is a corkscrew ridge that helps to twist the coupling onto the hose and, more importantly, helps to minimize the force of blow-back. Hose-to-hose or hose-to-pot connections are made by the 2-lug crowfoot design. No matter what the hose size, the 2-lug hose ends interchange for common connections.

SIZE	ALUMINUM	BRASS
3/4"	Q1A	Q1B
1"	Q2A	Q2B
1 1/4"	Q3A	Q3B
1 1/2"	Q4A	Q4B





# HOSE MENDERS

Hose menders repair hoses up to and including IDs of 12". After cutting out the damaged hose portion, insert each end of the mender (shanks) into the remaining good ends of the hose. Secure the mender with bands or DB double bolt clamps. Each end will accommodate two or more bands or two clamps for an economical and efficient return to service. Typically plated steel.

SIZE	PART #
1/2"	SM050
3/4"	SM075
1"	SM100
1 1/4"	SM125
1 1/2"	SM150
2"	SM200
2 1/2"	SM250

SIZE	PART #
3"	SM300
4"	SM400
5"	SM500
6"	SM600
8"	SM800
10"	SM1000
12"	SM1200





# PUSH-ON FITTINGS

Brass Push-On Fittings are specially manufactured for use with push-on hoses in low pressure applications. No clamp or ferrule is required if properly inserted. The barb will secure itself to the tube of the hose. Females also available in a swivel.

## MALE THREADS

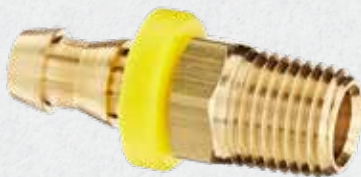

## FEMALE THREADS



## PUSH-ON MENDERS



## MALE THREADS

HOSE SIZE	THREAD SIZE	PART #
1/4"	1/8"	BMP-0402
1/4"	1/4"	BMP-0404
1/4"	3/8"	BMP-0406
5/16"	1/4"	BMP-0504
3/8"	1/8"	BMP-0602
3/8"	1/4"	BMP-0604
3/8"	3/8"	BMP-0606
3/8"	1/2"	BMP-0608
1/2"	1/4"	BMP-0804
1/2"	3/8"	BMP-0806
1/2"	1/2"	BMP-0808
1/2"	3/4"	BMP-0812
5/8"	3/8"	BMP1008
5/8"	1/2"	BMP-1012
3/4"	1/2"	BMP-1208
3/4"	3/4"	BMP-1212

## FEMALE THREADS

HOSE SIZE	THREAD SIZE	PART #
1/4"	1/8"	BFP-0402
1/4"	1/4"	BFP-0404
5/16"	1/4"	BFP-0504
3/8"	1/4"	BFP-0604
3/8"	3/8"	BFP-0606
1/2"	3/8"	BFP-0806
1/2"	1/2"	BFP-0808

## PUSH-ON MENDERS

HOSE SIZE	PART #
1/4"	BHP-0404
5/16"	BHP-0505
3/8"	BHP-0606
1/2"	BHP-0808
5/8"	BHP-1010
3/4"	BHP-1212



# BRASS THREADED HOSE FITTINGS

Recommended for low pressure air and water applications. Attachable with ferrules or hose clamps. Also available in stainless steel.

## MALE NPT



HOSE SIZE X NPT	PART #
1/4 x 1/8	BM-0402
1/4 x 1/4	BM-0404
1/4 x 3/8	BM-0406
5/16 x 1/8	BM-0502
5/16 x 1/4	BM-0504
3/8 x 1/8	BM-0602
3/8 x 1/4	BM-0604
3/8 x 3/8	BM-0606
3/8 x 1/2	BM-0608
1/2 x 1/4	BM-0804
1/2 x 3/8	BM-0806
1/2 x 1/2	BM-0808
1/2 x 3/4	BM-0812
5/8 x 3/8	BM-1006
5/8 x 1/2	BM-1008
5/8 x 3/4	BM-1012
3/4 x 1/2	BM-1208
3/4 x 3/4	BM-1212
1 x 3/4	BM-1612
1 x 1	BM-1616
1-1/4 x 1	BM-2016

## FEMALE NPT



HOSE SIZE X NPT	PART #
1/4 x 1/8	BF-0402
1/4 x 1/4	BF-0404
5/16 x 1/4	BF-0504
3/8 x 1/4	BF-0604
3/8 x 3/8	BF-0606
1/2 x 3/8	BF-0806
1/2 x 1/2	BF-0808

## FEMALE NPSM SWIVEL (BALL SEAT)



HOSE SIZE X NPSM	PART #
1/4 x 1/4	BFS-0404
5/16 x 1/4	BFS-0504
3/8 x 1/4	BFS-0604
3/8 x 3/8	BFS-0606
1/2 x 3/8	BFS-0806
1/2 x 1/2	BFS-0808
3/4 x 3/4	BFS-1212

\* RAGCO supports the autonomy of its locations to select the best products to service their markets. Subtle variations of these specifications may exist. Contact your RAGCO affiliate for confirmation.



# GARDEN HOSE FITTINGS

Brass fittings with standard garden hose thread (GHT) for general purpose use. The female end swivels for easy connection. Many adapters are available for making the connection to the pipe thread.

## GARDEN HOSE FITTING SET

HOSE SIZE	PART #
3/8"	GHS-06
1/2"	GHS-08
5/8"	GHS-10
3/4"	GHS-12

## GARDEN HOSE MALE

HOSE SIZE	PART #
3/8"	GHM-06
1/2"	GHM-08
5/8"	GHM-10
3/4"	GHM-12

## GARDEN HOSE FEMALE

HOSE SIZE	PART #
3/8"	GHF-06
1/2"	GHF08
5/8"	GHF-10
3/4"	GHF-12





# LOCKING LEVER COUPLINGS

For use with water pumps and irrigation. Locking lever fittings are galvanized quick couplings, each with a double-pin locking lever for smooth closing. Not recommended for use with toxic chemicals. O-Ring is included in all female parts.

**FULL VACUUM RATED**  
**30° ARTICULATION**  
**TYPE B INDUSTRIAL**  
**NBR O-RING**

**LOCK PIN LEVER**  
**INTERCHANGEABLE**  
**GALVANIZED**  
**QUICK AND EASY CONNECTIONS**

## MALE X FEMALE ASSEMBLY

SIZE	PART #
2"	BGA200
3"	BGA300
4"	BGA400
6"	BGA600
8"	BGA800

## MALE X HOSE SHANK

SIZE	PART #
2"	BMS200
3"	BMS300
4"	BMS400
6"	BMS600
8"	BMS800

## FEMALE X HOSE SHANK

SIZE	PART #
2"	BFS200
3"	BFS300
4"	BFS400
6"	BFS600
8"	BFS800



\* RAGCO supports the autonomy of its locations to select the best products to service their markets. Subtle variations of these specifications may exist. Contact your RAGCO affiliate for confirmation.



# LOCKING LEVER COUPLINGS CONTINUED

## MALE X MALE THREAD

SIZE	PART #
2"	BMT200
3"	BMT300
4"	BMT400
6"	BMT600
8"	BMT800



## FEMALE X MALE THREAD

SIZE	PART #
2"	BFT200
3"	BFT300
4"	BFT400
6"	BFT600
8"	BGT800



## MALE X 150# FLANGE

SIZE	PART #
4"	BMF400
6"	BMF600
8"	BMF800



## FEMALE X 150# FLANGE

SIZE	PART #
4"	BFF400
6"	BFF600
8"	BFF800



## LOCKING LEVER

SIZE	PART #
2"	BLR200
3"	BLR300
4"	BLR400
6"	BLR600
8"	BLR800



## O-RING

SIZE	PART #
2"	BOR200
3"	BOR300
4"	BOR400
6"	BOR600
8"	BOR800





# QUICK DISCONNECT FITTINGS





# QUICK DETACHABLE COUPLERS

**HOW TO SELECT:** Proper coupler selection is important because of the variety of media for which they are used. Four basic factors should be considered to assure proper selection: **type – operation – flow – media**

**TYPE:** All couplers consist of two basic components – a socket and a plug. The type of coupler varies by the valving arrangements in these two components.



**MANUAL SOCKETS** require manual retraction of the sleeve to both connect and disconnect the plug. Ball Lock (BL) is an optional feature available on manual sockets. After connection, the sleeve is rotated locking the coupler against accidental disconnect.



**AUTOMATIC SOCKETS** accept the plug by simple insertion into the socket and do not require retraction of the sleeve to connect. Sleeve Lock (SL) is an optional feature on automatic sockets to prevent accidental disconnect. It is functionally the same as the Ball Lock (BL) on manual sockets.



**SAFETY SOCKETS** are a variation of automatic operation. The socket accepts the plug by insertion. The sleeve is moved straight forward to lock and turn on the air. The sleeve is moved back by rotating first to the left and then to the right. This shuts off the supply line, exhausts the downstream line, and then releases the plug.

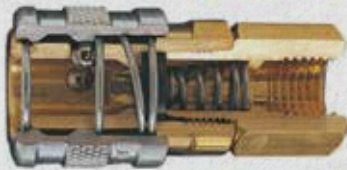

**ONE-WAY SHUT-OFFS** are the only sockets that have valving to shut off the flow when disconnected; they are, therefore, installed on the pressure side of the line. The plug has no valving and exhausts the downstream line at disconnect.

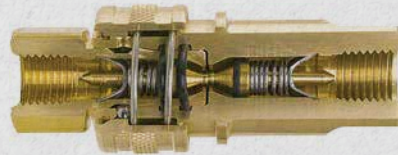

**TWO-WAY SHUT-OFFS** provide valving in both the socket and the plug, thereby shutting off flow at both of the disconnected ends. Originally developed for hydraulic lines, they are suitable for many other media because of the variety of metals and seal compounds offered.



**STRAIGHT-THRU** couplers, as the name implies, do not have valving in either the socket or the plug. Therefore, both ends of the line are exhausted at disconnect.

**OPERATION:** Operation refers to the action required to connect and disconnect a coupler. Operation is a function of sockets only and does not vary for plugs.

**FLOW:** The most important factor in properly sizing couplers is flow. Flow data is given throughout the catalog for industrial interchange design couplers, as well as many of Ragco's interchanges for competitors' non-standard designs. Where flow information is not shown, it is the same as the originating competitors' non-standard design. Most one-way shut-off non-standard couplers have the same flow as the same basic size industrial interchange design. All flows shown are for FPT couplers.

**MEDIA:** The media flowing through the coupler will usually determine the type. Compressed air, many other gasses, and some liquids can be handled by one-way shut-off couplers. Hydraulic fluids as well as many other liquids and some gasses require two-way shut-off. Straight-thru couplers are suitable where there is no pressure in the line at connect or disconnect, and loss of media at disconnect does not matter.



# ONE-WAY SHUT-OFF SERIES 3 THRU 6

Ragco 3 thru 6 Series couplers are designed for rigid mounting that allows a simple push-to-connect operation, constructed of a solid brass body and a steel valve. The "FM" Series are mechanically interchangeable with similar industrial interchange couplings made by other manufacturers and accept plugs that conform to MIL-C4109-F. Plugs used with the "FM" Series are the Industrial Interchange plugs. FM Series 3 and 5 couplers comply with A-A-59439.

## SLEEVE-LOCK OPTION

Sleeve-Lock feature locks automatic socket against accidental disconnect. To connect, align ball with slot. After connection, rotate sleeve to lock. To disconnect, realign ball with slot and retract sleeve. Sizes available with sleeve lock are shown in the tables on following pages.



SPECIFICATIONS	BODY SIZE			
	1/4"	3/8"	1/2"	3/4"
Rated Pressure (psi)	300 PSIG; vacuum to 26" Hg			
Temperature Range (std seals)	-40° to +250° F			
Locking Device	3 pawls	4 pawls	5 pawls	6 pawls
<b>Vacuum Data</b>				
Disconnected (coupler only)	Not Recommended			
Connected	27.4 inches Hg			
Approximate CFM at 100 (psi)	37	70	150	

## OPTIONAL SEAL [ORDERING]:

Buna-N seal is standard. Alternate seals are specified by the appropriate suffix on the catalog number. For example, 3003 socket with Heat Adder is 3003H.

SERVICE	CONSTRUCTION	SEAL	TEMPERATURE	SUFFIX
Air, Vacuum, Grease & Oil	Brass & Steel	Buna-N	40° to +250°F	none
Water	Brass & S/S	Buna-N	+32° to +100°F	W
Hot Water	Brass & S/S	Viton	-40° to +400°F	HW
Steam	Brass & S/S	EPDM	-40° to +250°F	S
Heat	Brass & Steel	Viton	-40° to +400°F	H
Less Valve	Brass & Steel	Buna-N	-40° to +250°F	LV

Note: Temperatures shown are seal compatibility. Consult factory for operational characteristics.



# ONE-WAY SHUT-OFF SERIES 2 THRU 6

## FEATURES:

- High flow metal valves.
- Precision molded seals form a “bubble-tight” seal for reliable operation within rated working pressures. Nitrile (Buna-N) seals are standard. EPDM, Viton and Neoprene seals are available as options.
- Proven ball-locking mechanism with large numbers of stainless-steel locking balls evenly distribute the load to resist wear and provide positive connections, and allow a swiveling action to reduce hose torque.
- Integral sleeve guard protects the sleeve and resists accidental disconnects for the “SG” series.
- Knurling and/or grooves on the sleeve provide a gripping surface for ease of operation.
- Wide range of body sizes, materials, options and end terminations are available to meet specific needs.
- Accepts Industrial Interchange Plug.



**OPERATION:** Sleeve-type couplings are widely used to connect air and low-pressure fluid lines. Their compact and economical design uses a ball-locking mechanism consisting of captive stainless-steel balls that engage the locking groove on the mating plug. The sliding spring-loaded sleeve on the socket must be manually retracted in order to connect or disconnect the plug.

**MATERIAL:** Brass body and socket end, zinc-plated steel sleeve

**WORKING PRESSURE:** 300 PSIG; vacuum to 26” Hg

**INTERCHANGEABILITY:** Complies with ANSI/NFPA T3.20.14-1990 & ISO 6150-B

SPECIFICATIONS	BODY SIZE		
	1/4"	3/8"	1/2"
Rated Pressure (psi)	300	300	300
Temp. Range (Buna-N Seal)	-40° to +250° F		
Locking Device	Stainless Steel Balls		
Vacuum Data (inches Hg)			
-- Disconnected (coupler only)	Not Recommended		
-- Connected	27.4	27.4	27.4
Approximate CFM at 100 (psi)	37	70	150

# ONE-WAY SHUT-OFF 2 SERIES

## 2 SERIES 1/8" PLUGS

REUSABLE		PART NO.	I.D. X O.D.	DESCRIPTION
		PB3-2	1/4" x 1/2"	Steel
		PB5-2	1/4" x 9/16"	
		PB7-2	1/4" x 5/8"	

FEMALE THREAD		PART NO.	FPT	DESCRIPTION
		23-2	1/8"	Steel
		27-2	1/4"	



  

MALE THREAD		PART NO.	MPT	DESCRIPTION
		22-2	1/8"	Steel
		22-2B	1/8"	Brass
		22-2S/S	1/8"	303 Stainless
		24-2	1/4"	Steel

HOSE STEM		PART NO.	I.D.	DESCRIPTION
		02-2	1/8"	Steel Requires Hose Clamp
		03-2	3/16"	
		04-2	1/4"	

REUSABLE		PART NO.	I.D. X O.D.	DESCRIPTION
		PB3-2	1/4" x 1/2"	Steel
		PB5-2	1/4" x 9/16"	
		PB7-2	1/4" x 5/8"	

 Non-Standard Product       Standard Product







# ONE-WAY SHUT-OFF 2 SERIES

## 2 SERIES 1/8" SOCKETS

PLASTIC AND METAL TUBING		PART NO.	SIZE	DESCRIPTION
		SJ8-2	.170" x 1/4"	Plastic
		BLSJ8-2		Ball Lock, 1/4" Plastic
		SJ8-2M	1/4"	Soft Metal
		BLSJ8-2M		Ball Lock, Soft Metal
		SJ8-2S/S		303 Stainless

PLASTIC & METAL TUBING		PART NO.	SIZE	DESCRIPTION
		SJ8P-2	.170" x 1/4"	Plastic
		BLSJ8P-2		Ball Lock, Plastic
		SJ8P-2HW		Plastic for Hot Water
		SJ8P-2W		Plastic, for Water
		SJ8P-2M	1/4"	Soft Metal
		BLSJ8P-2M		Ball Lock, Soft Metal

MALE THREAD		PART NO.	MPT	DESCRIPTION
		2202	1/8"	Brass/Steel
		BL2202		Ball Lock
		2202S/S		Brass
		BL2202S/S		Ball Lock, 303 Stainless
		2202H		For Heat, Viton Seal
		2202S	For Steam, Brass/SS, EPDM Seal	
		2202W	For Water, Brass/SS, Buna-N Seal	
		2402	1/4"	Brass/Steel
BL2402	Ball Lock			
2402H	For Heat, Viton Seal			

Non-Standard Product       Standard Product

FEMALE THREAD		PART NO.	FPT	DESCRIPTION
		2302	1/8"	Brass/Steel
		BL2302		Ball Lock
		2302H		Brass/Steel For Heat, Viton Seal
		2302HW		Brass/SS For Hot Water, Viton Seal
		2302S/S		303 Stainless
		BL2302S/S		Ball Lock, 303 Stainless
		2302S/SH	303 Stainless For Heat, Viton Seal	
		2302W	Brass/SS For Water, Buna-N Seal	
		2702	1/4"	Brass/Steel
		BL2702		Ball Lock
		2702H		Brass/Steel For Heat, Viton Seal
2702HW	Brass/SS For Hot Water, Viton Seal			

HOSE STEM		PART NO.	I.D.	DESCRIPTION
		2022	1/8"	Brass/Steel
		BL2022		Ball Lock
		2022W		For Water, Brass/SS, Buna-N Seal
		2032	3/16"	Brass/Steel
		BL2032		Ball Lock
		2032HW		For Hot Water, Brass/SS, Viton Seal
		2032S		For Steam, Brass/SS, EPDM Seal
		2042	1/4"	Brass/Steel
		BL2042		Ball Lock
2042HW	For Hot Water, Brass/SS, Viton Seal			

Requires Hose Clamp

\* RAGCO supports the autonomy of its locations to select the best products to service their markets. Subtle variations of these specifications may exist. Contact your RAGCO affiliate for confirmation.



# ONE-WAY SHUT-OFF 3 SERIES

## 3 SERIES 1/4" PLUGS

FEMALE THREAD		PART NO.	FPT	DESCRIPTION
		13-3	1/8"	Steel
		13-3B		Brass
		13-3S/S		303 Stainless
		11-3	1/4"	Steel
		11-3B		Brass
		11-3S/S		303 Stainless
		15-3	3/8"	Steel

HOSE STEM		PART NO.	I.D.	DESCRIPTION
		16-3	1/4"	Steel
		16-3B		Brass
		165-3	5/16"	Steel
		17-3	3/8"	Steel
		17-3B		Brass

Requires Hose Clamp

MALE THREAD		PART NO.	MPT	DESCRIPTION
		12-3	1/8"	Steel
		12-3B		Brass
		12-3S/S		303 Stainless
		12S-3		Free Swivel Under Pressure Steel
		10-3	1/4"	Steel
		10-3B		Brass
		10-3S/S		303 Stainless
		10-3D		w/Dill Valve Steel
		10-3G		Ball Check, Steel
		10-3GB		Ball Check, Brass
		10-3GS		Ball Check, Spring Loaded, For Steam, Brass/SS Material, EPDM Seal
		10-3GS/S		Ball Check, 303 Stainless
		10S-3		Free Swivel Under Pressure
		10-3DB		Brass, Valve Core Plug
		14-3	3/8"	Steel
		14-3B		Brass
		14-3GB		Ball Check, Brass
		14S-3		Free Swivel Under Pressure

PUSH-ON HOSE STEM		PART NO.	I.D.	DESCRIPTION
		51-3	1/4"	Steel
		71-3	3/8"	Steel

Hose clamps not required when used with "Push On" hose.

REUSABLE HOSE CLAMP		PART NO.	I.D. X O.D.	DESCRIPTION
		PB3-3	1/4" x 1/2"	Steel
		PB3-3B	1/4" x 1/2"	Brass
		PB3-3S/S	1/4" x 1/2"	303 Stainless
		PB5-3	1/4" x 9/16"	Steel
		PB5-3B	1/4" x 9/16"	Brass
		PB7-3	1/4" x 5/8"	Steel
		PB7-3B	1/4" x 5/8"	Brass
		PB7-3S/S	1/4" x 5/8"	303 Stainless
		PC5-3	5/16" x 9/16"	Steel
		PC7-3	5/16" x 5/8"	Steel
		PD7-3	3/8" x 5/8"	Steel
		PD9-3	3/8" x 11/16"	Steel
		PD11-3	3/8" x 3/4"	Steel
		PD13-3	3/8" x 13/16"	Steel

Non-Standard Product

Standard Product

[1] Ball check plug eliminates hose whip at disconnect by checking the rapid flow of downstream exhaust air.

[2] Swivel Plug – Eliminates hose twist on end-drop applications such as blow guns, air tools, etc.



# ONE-WAY SHUT-OFF 3 SERIES

## DUST CAPS

DUST CAP		PART NO.	SIZE	DESCRIPTION
		3PDC	1/4"	Plastic

DUST CAP		PART NO.	I.D. X O.D.	DESCRIPTION
		3SDC	1/4"	For Manual 1/4" only

## 3 SERIES 1/4" ONE-WAY MANUAL SLEEVE-GUARD SOCKETS

FEMALE THREAD		PART NO.	FPT	DESCRIPTION
		SG2803	1/8"	Brass
		SG3003	1/4"	
		SG3003LV	1/4"	Brass, less Valve
SG3203	3/8"	Brass		

HOSE STEM		PART NO.	I.D.	DESCRIPTION
		SG3603	1/4"	Brass
		SG3703	3/8"	

MALE THREAD		PART NO.	MPT	DESCRIPTION
		SG2903	1/8"	Brass
		SG3103	1/4"	
		SG3103D	1/4"	Brass w/Dill Valve
SG3303	3/8"	Brass		

PUSH-ON HOSE STEM		PART NO.	I.D.	DESCRIPTION
		SG1513	1/4"	Brass
		SG1713	3/8"	

Hose clamps not required when used with "Push-On" hose.

[1] Sockets with modified valves are recommended for use with valve core plugs. Suffix-D to socket Cat. No.

## 3 SERIES 1/4" ONE-WAY AUTOMATIC SOCKETS

REUSABLE HOSE CLAMP		PART NO.	I.D. X O.D.	DESCRIPTION
		FMSB3-3	1/4" x 1/2"	Brass
		FMSB5-3	1/4" x 9/16"	
		FMSB7-3	1/4" x 5/8"	
		FMSC5-3	5/16" x 9/16"	
		FMSC7-3	5/16" x 5/8"	
		FMSD7-3	3/8" x 5/8"	
		FMSD9-3	3/8" x 11/16"	
		FMSD11-3	3/8" x 3/4"	
		FMSD13-3	3/8" x 13/16"	

REUSABLE HOSE CLAMP WITH SLEEVE LOCK		PART NO.	I.D. X O.D.	DESCRIPTION
		SLSB3-3	1/4" x 1/2"	Sleeve Lock, Brass
		SLSB5-3	1/4" x 9/16"	
		SLSB7-3	1/4" x 5/8"	
		SLSB7-3W		Sleeve Lock, For Water, Brass/SS, Buna-N Seal
		SLSC5-3	5/16" x 9/16"	Sleeve Lock, Brass
		SLSC7-3	5/16" x 5/8"	
		SLSL7-3	3/8" x 5/8"	
		SLSL9-3	3/8" x 11/16"	
		SLSL11-3	3/8" x 3/4"	
SLSL13-3	3/8" x 13/16"			



Non-Standard Product



Standard Product

\* RAGCO supports the autonomy of its locations to select the best products to service their markets. Subtle variations of these specifications may exist. Contact your RAGCO affiliate for confirmation.



# ONE-WAY SHUT-OFF 3 SERIES

## 3 SERIES 1/4" ONE-WAY AUTOMATIC SOCKETS (CONTINUED)

FEMALE THREAD		PART NO.	FPT	DESCRIPTION
		FM2803	1/8"	Brass
		FM2803S		For Steam, Brass/SS, EPDM Seal
		SL2803		Sleeve Lock
		FM2803W		For Water, Brass/SS, Buna-N Seal
		FM3003	1/4"	Brass
		SL3003		Sleeve Lock
		FM3003HW		For Hot Water, Brass/SS, Viton Seal
		FM3003S		For Steam, Brass/SS, EPDM Seal
		FM3003W		For Water, Brass/SS, Buna-N Seal
		SL3003W		Sleeve Lock, For Water, Brass/SS, Buna-N Seal
		FM3203	3/8"	Brass
		SL3203		Sleeve Lock
		FM3203H		For Heat, Viton Seal
FM3203W	For Water, Brass/SS, Buna-N Seal			



MALE THREAD		PART NO.	MPT	DESCRIPTION
		FM2903	1/8"	Brass
		SL2903		Sleeve Lock, Brass
		FM3103		Brass
		SL3103		Sleeve Lock, Brass
		FM3103D	1/4"	w/Dill Valve
		SL3103D		Sleeve Lock, w/Dill Valve, Brass
		FM3103H		For Heat, Viton Seal
		FM3103HW		For Hot Water, Brass/SS, Viton Seal
		SL3103HW		Sleeve Lock, For Hot Water, Brass/SS, Viton Seal
		FM3103S		For Steam, Brass/SS, EPDM Seal
		FM3103W	3/8"	For Water, Brass/SS, Buna-N Seal
		SL3103W		Sleeve Lock, For Water, Brass/SS, Buna-N Seal
		FM3303		Brass
SL3303	Sleeve Lock, Brass			
FM3303W		For Water, Brass/SS, Buna-N Seal		

HOSE STEM		PART NO.	I.D.	DESCRIPTION
		FM3603	1/4"	Brass
		SL3603	1/4"	Sleeve Lock, Brass
		FM3603S	1/4"	For Steam, Brass/SS, EPDM Seal
		FM3653	5/16"	Brass
		SL3653	5/16"	Sleeve Lock, Brass
		FM3703	3/8"	Brass
		SL3703	3/8"	Sleeve Lock, Brass
		FM3703S	3/8"	For Steam, Brass/SS, EPDM Seal

Requires Hose Clamps

PUSH-ON HOSE STEM		PART NO.	I.D.	DESCRIPTION
		FM1513	1/4"	Brass
		SL1513	1/4"	Sleeve Lock, Brass
		FM1713	3/8"	Brass
		SL1713	3/8"	Sleeve Lock, Brass
		FM1713W	3/8"	For Water, Brass/SS, Buna-N Seal

Hose clamps not required when used with "Push-On" hose.

 Non-Standard Product     Standard Product



# ONE-WAY SHUT-OFF 3 SERIES

## 3 SERIES 1/4" ONE-WAY MANUAL SOCKETS

FEMALE THREAD			MALE THREAD			
PART NO.	FPT	DESCRIPTION	PART NO.	MPT	DESCRIPTION	
2803	1/8"	Brass/Steel	2903	1/8"	Brass/Steel	
BL2803		Ball Lock	BL2903		Ball Lock	
2803GB		Brass	2903GB		Brass	
2803GS		Steel	2903GS		Steel	
2803H		Steel, For Heat, Viton Seal	2903H		Steel, For Heat, Viton Seal	
2803S		Brass/SS, For Steam, EPDM Seal	2903S		Brass/SS, For Steam, EPDM Seal	
2803S/S		303 Stainless	2903S/S		303 Stainless	
BL2803S/S		Ball Lock, 303 Stainless	BL2903S/S		Ball Lock, 303 Stainless	
2803W		Brass/SS, For Water, Buna-N Seal	3103		1/4"	Brass/Steel
3003		Brass/Steel	BL3103			Brass/Steel, Ball Lock
BL3003	Ball Lock	3103D	Brass/Steel, w/Dill Valve			
3003D	w/Dill Valve	3103GB	Brass			
3003GB	Brass	3103GS	Steel			
3003GS	Steel	3103H	Brass/Steel, For Heat, Viton Seal			
3003H	Steel, For Heat, Viton Seal	3103LV	Brass/Steel, Less Valve			
3003HW	Brass/SS, For Hot Water, Viton Seal	3103S	Brass/SS, For Steam, EPDM Seal			
3003LV	Steel, Less Valve	3103S/S	303 Stainless			
3003S	Brass/SS, For Steam, EPDM Seal	BL3103S/S	Ball Lock, 303 Stainless			
3003S/S	303 Stainless	BL3103S/S-104	Ball Lock, 303 Stainless, w/Silicone Seal			
BL3003S/S	Ball Lock, 303 Stainless	3103S/SH	303 Stainless, For Heat, Viton Seal			
3003S/SH	303 Stainless, For Heat, Viton Seal	3103S/SLV	303 Stainless, Less Valve			
3003W	Brass/SS, For Water, Buna-N Seal	3103W	Brass/SS, For Water, Buna-N Seal			
BL3003W	Brass/SS, Ball Lock, For Water, Buna-N Seal	BL3103W	Ball Lock, For Water, Brass/SS, Buna-N Seal			
3203	3/8"	Brass/Steel	3303	3/8"	Brass/Steel	
BL3203		Ball Lock	BL3303		Ball Lock	
3203GB		Brass	3303GB		Brass	
3203GS		Steel	3303GS		Steel	
3203H		Steel, For Heat, Viton Seal	3303H		Steel, For Heat, Viton Seal	
3203LV		Steel, Less Valve	3303S/S		303 Stainless	
3203S/S		303 Stainless	BL3303S/S		Ball Lock, 303 Stainless	
BL3203S/S		Ball Lock, 303 Stainless	3303W		Brass/SS, For Water, Buna-N Seal	
3203S/SLV		Less Valve, 303 Stainless				
3203W		Brass/SS, For Water, Buna-N Seal				

 Non-Standard Product

 Standard Product

\* RAGCO supports the autonomy of its locations to select the best products to service their markets. Subtle variations of these specifications may exist. Contact your RAGCO affiliate for confirmation.



# ONE-WAY SHUT-OFF 3 SERIES

## 3 SERIES 1/4" ONE-WAY MANUAL SOCKETS (CONTINUED)

HOSE STEM		PART NO.	I.D.	DESCRIPTION
		3603	1/4"	Brass/Steel
		BL3603		Ball Lock
		3603GB		Brass
		3603GS		Steel
		3603S		Brass/SS, For Steam, EPDM Seal
		3603S/S		303 Stainless
		BL3603S/S		Ball Lock, 303 Stainless
		3603W		Brass/SS, For Water, Buna-N Seal
		3653		5/16"
BL3653	Ball Lock			
3653GB	Brass			
3653GS	Steel			
3703	3/8"	Brass/Steel		
BL3703		Ball Lock		
3703GB		Brass		
3703GS		Steel		
3703S		Brass/SS, For Steam, EPDM Seal		
3703S/S		303 Stainless		
BL3703S/S		Ball Lock, 303 Stainless		
3703W		Brass/SS, For Water, Buna-N Seal		

Requires Hose Clamp

PUSH-ON HOSE STEM		PART NO.	I.D.	DESCRIPTION
		1513	1/4"	Brass/Steel
		BL1513		Ball Lock
		1513GB		Brass
		1513W	For Water, Brass/SS, Buna-N Seal	
		1713	3/8"	Brass/Steel
		BL1713		Ball Lock
		1713GB		Brass
		1713W		For Water, Brass/SS, Buna-N Seal

Hose clamps not required when used with "Push-On" hose.

Non-Standard Product       Standard Product

REUSABLE HOSE CLAMP		PART NO.	I.D. X O.D.	DESCRIPTION	
		SB3-3	1/4" x 1/2"	Brass/Steel	
		BLSB3-3W		Ball Lock, For Water, Brass/SS, Buna-N Seal	
		SB3-3GB		Brass	
		SB3-3GS		Steel	
		SB3-3S/S		303 Stainless	
		SB3-3W		For Water, Brass/SS, Buna-N Seal	
		SB5-3		1/4" x 9/16"	Brass/Steel
		BLSB5-3			Ball Lock
		SB5-3GB			Brass
SB5-3GS	Steel				
BLSB5-3W	Ball Lock, For Water, Brass/SS, Buna-N Seal				
SB7-3	1/4" x 5/8"	Brass/Steel			
BLSB7-3		Ball Lock			
SB7-3GB		Brass			
SB7-3GS		Steel			
SB7-3S/S		303 Stainless			
BLSB7-3S/S		Ball Lock, 303 Stainless			
SB7-3W		For Water, Brass/SS, Buna-N Seal			
BLSB7-3W		Ball Lock, For Water, Brass/SS, Buna-N Seal			
SC5-3		5/16" x 9/16"	Brass/Steel		
BLSC5-3			Ball Lock		
SC7-3	5/16" x 5/8"	Brass/Steel			
BLSC7-3		Ball Lock			
SD7-3	3/8" x 5/8"	Brass/Steel			
BLSD7-3		Ball Lock			
SD7-3GB		Brass			
SD7-3GS	Steel				
SD9-3	3/8" x 11/16"	Brass/Steel			
BLSD9-3		Ball Lock			
SD11-3	3/8" x 3/4"	Brass/Steel			
BLSD11-3		Ball Lock			
SD11-3GB		Brass			
SD11-3GS		Steel			
SD13-3	3/8" x 13/16"	Brass/Steel			
BLSD13-3		Ball Lock			

[1] Sockets with modified valves (Dill Valve) are recommended for use with valve core plugs.







# ONE-WAY SHUT-OFF 4 SERIES

## 4 SERIES 3/8" PLUGS

HOSE STEM		PART NO.	I.D.	DESCRIPTION
		46-4	1/4"	Steel
		47-4	5/16"	
		48-4	3/8"	
		48-4B	3/8"	Brass
49-4	1/2"	Steel		

Requires Hose Clamps

MALE THREAD FREE SWIVEL - UNDER PRESSURE		PART NO.	MPT	DESCRIPTION
		40S-4	1/4"	Steel
42S-4	3/8"			

FEMALE THREAD		PART NO.	FPT	DESCRIPTION
		41-4	1/4"	Steel
		43-4	3/8"	
		43-4S/S		303 Stainless
		45-4	1/2"	Steel

PUSH-ON HOSE STEM		PART NO.	I.D.	DESCRIPTION
		51-4	1/4"	Steel
		71-4	3/8"	
		71-4B		Brass
81-4	1/2"	Steel		

Hose clamps not required when used with "Push On" hose.

MALE THREAD		PART NO.	MPT	DESCRIPTION
		38-4	1/8"	Steel
		40-4	1/4"	
		40-4B		Brass
		40-4S/S		303 Stainless
		42-4	3/8"	Steel
		42-4B		Brass
		42-4S/S		303 Stainless
		44-4	1/2"	Steel

REUSABLE		PART NO.	I.D. X O.D.	DESCRIPTION
		PB3-4	1/4" x 1/2"	Steel
		PB5-4	1/4" x 9/16"	Steel
		PB7-4	1/4" x 5/8"	Steel
		PD7-4	3/8" x 5/8"	Steel
		PD9-4	3/8" x 11/16"	Steel
		PD11-4	3/8" x 3/4"	Steel
PD13-4	3/8" x 13/16"	Steel		

## 4 SERIES 3/8" ONE-WAY MANUAL SOCKETS

FEMALE THREAD		PART NO.	FPT	DESCRIPTION
		4004	1/4"	Brass/Steel
		BL4004		Ball Lock, Brass/Steel
		4204	3/8"	Brass/Steel
		BL4204		Ball Lock, Brass/Steel
		4204H		For Heat, Viton Seal, Brass/Steel
		4204S		For Steam, Brass/SS, EPDM Seal
		4204S/S		303 Stainless
		BL4204S/S		Ball Lock, 303 Stainless
		4204W		For Water, Brass/SS, Buna-N Seal
		4404	1/2"	Brass/Steel
		BL4404		Ball Lock, Brass/Steel

HOSE STEM		PART NO.	I.D.	DESCRIPTION
		4604	1/4"	Brass/Steel
		BL4604		Ball Lock, Brass/Steel
		4604W		For Water, Brass/SS, Buna-N Seal
		4704	5/16"	Brass/Steel
		BL4704		Ball Lock, Brass/Steel
		4804	3/8"	Brass/Steel
		BL4804		Ball Lock, Brass/Steel
		4804S		For Steam, Brass/SS, EPDM Seal
		4804W		For Water, Brass/SS, Buna-N Seal
		4904	1/2"	Brass/Steel
		BL4904		Ball Lock, Brass/Steel
4904S	For Steam, Brass/SS, EPDM Seal			

Requires Hose Clamp

Non-Standard Product       Standard Product

\* RAGCO supports the autonomy of its locations to select the best products to service their markets. Subtle variations of these specifications may exist. Contact your RAGCO affiliate for confirmation.



# ONE-WAY SHUT-OFF 4 SERIES

## 4 SERIES 3/8" ONE-WAY MANUAL SOCKETS

MALE THREAD		PART NO.	MPT	DESCRIPTION
		4104	1/4"	Brass/Steel
		BL4104		Ball Lock, Brass/Steel
		4104H		For Heat, Viton Seal, Brass/Steel
		4104S		For Steam, Brass/SS, EPDM Seal
		4104W		For Water, Brass/SS, Buna-N Seal
		4304	3/8"	Brass/Steel
		BL4304		Ball Lock, Brass/Stel
		4304S		For Steam, Brass/SS, EPDM Seal
		4304S/S		303 Stainless
		BL4304S/S		Ball Lock, 303 Stainless
		4304W	For Water, Brass/SS, Buna-N Seal	
		4504	1/2"	Brass/Steel
		BL4504		Ball Lock, Brass/Steel
		4504H		For Heat, Viton Seal, Brass/Steel
4504S	For Steam, Brass/SS, EPDM Seal			
4504W	For Water, Brass/SS, Buna-N Seal			



REUSABLE HOSE CLAMP		PART NO.	I.D. X O.D.	DESCRIPTION
		SB3-4	1/4" x 1/2"	Brass/Steel
		BLSB3-4		Ball Lock, Brass/Steel
		SB5-4	1/4" x 9/16"	Brass/Steel
		BLSB5-4		Ball Lock, Brass/Steel
		SB7-4	1/4" x 5/8"	Brass/Steel
		BLSB7-4		Ball Lock, Brass/Steel
		SD7-4	3/8" x 5/8"	Brass/Steel
		B LSD7-4		Ball Lock, Brass/Steel
		SD9-4	3/8" x 11/16"	Brass/Steel
		B LSD9-4		Brass/Steel
		SD11-4	3/8" x 3/4"	Brass/Steel
		B LSD11-4		Ball Lock, Brass/Steel
		SD13-4	3/8" x 13/16"	Brass/Steel
		B LSD13-4		Ball Lock, Brass/Steel

[1] Ball check plugs eliminate hose whip at disconnect by checking the rapid flow of downstream exhaust air.

[2] Swivel Plug – Eliminates hose twist on end-drop applications such as blow guns, air tools, etc.

PUSH-ON HOSE STEM		PART NO.	I.D.	DESCRIPTION
		1714	3/8"	Brass/Steel
		BL1714		Ball Lock
		1714W		For Water, Brass/SS, Buna-N Seal
		1814	1/2"	Brass/Steel
		BL1814		Ball Lock
1814W	For Water, Brass/SS, Buna-N Seal			

Hose clamps not required when used with "Push-On" hose.

 Non-Standard Product       Standard Product



# ONE-WAY SHUT-OFF 4 SERIES

## 4 SERIES 3/8" ONE-WAY AUTOMATIC SOCKETS

FEMALE THREAD		PART NO.	FPT	DESCRIPTION
		FM4004	1/4"	Brass
		SL4004		Sleeve Lock Brass
		FM4204	3/8"	Brass
		SL4204		Sleeve Lock, Brass
		FM4204H		For Heat, Viton Seal
		FM4204W		For Water, Brass/SS, Buna-N Seal
		FM4404	1/2"	Brass
		SL4404		Sleeve Lock, Brass
		FM4404S		For Steam, Brass/SS, EPDM Seal
FM4404W	For Water, Brass/SS, Buna-N Seal			

HOSE STEM		PART NO.	I.D.	DESCRIPTION
		FM4604	1/4"	Brass
		SL4604		Sleeve Lock, Brass
		FM4704	5/16"	Brass
		SL4704		Sleeve Lock, Brass
		FM4804	3/8"	Brass
		SL4804		Sleeve Lock, Brass
		FM4804H		For Heat, Viton Seal
		FM4804W		For Water, Brass/SS, Buna-N Seal
		FM4904	1/2"	Brass
SL4904	Sleeve Lock, Brass			
FM4904W	For Water, Brass/SS, Buna-N Seal			

Requires Hose Clamp

REUSABLE HOSE CLAMP		PART NO.	I.D. X O.D.	DESCRIPTION
		FMSB3-4	1/4" x 1/2"	Brass
		SLSB3-4		Sleeve Lock, Brass
		FMSB5-4	1/4" x 9/16"	Brass
		SLSB5-4		Sleeve Lock, Brass
		FMSB7-4	1/4" x 5/8"	Brass
		SLSB7-4		Sleeve Lock, Brass
		FMSD7-4	3/8" x 5/8"	Brass
		S LSD7-4		Sleeve Lock, Brass
		FMSD9-4	3/8" x 11/16"	Brass
		S LSD9-4		Sleeve Lock, Brass
		FMSD11-4	3/8" x 3/4"	Brass
		S LSD11-4		Sleeve Lock, Brass
		FMSD13-4	3/8" x 13/16"	Brass
		S LSD13-4		Sleeve Lock, Brass

PUSH-ON HOSE STEM		PART NO.	I.D.	DESCRIPTION
		FM1714	3/8"	Brass
		SL1714		Sleeve Lock, Brass
		FM1814	3/8"	Brass
		SL1814		Sleeve Lock, Brass
		FM1814W		For Water, Brass/SS, Buna-N Seal
FM1814W	For Water, Brass/SS, Buna-N Seal			

Hose clamps not required when used with "Push-On" hose.

MALE THREAD		PART NO.	MPT	DESCRIPTION
		FM4104	1/4"	Brass
		SL4104		Sleeve Lock, Brass
		FM4104S		For Steam, Brass/SS, EPDM Seal
		FM4104W		For Water, Brass/SS, Buna-N Seal
		FM4304	3/8"	Brass
		SL4304		Sleeve Lock, Brass
		FM4304S		For Steam, Brass/SS, EPDM Seal
		FM4304W		For Water, Brass/SS, Buna-N Seal
		FM4504	1/2"	Brass
		SL4504		Sleeve Lock, Brass
		FM4504S		For Steam, Brass/SS, EPDM Seal
FM4504W	For Water, Brass/SS, Buna-N Seal			

[1] Swivel Plug – Eliminates hose twist on end-drop applications such as blow guns, air tools, etc.

[2] Ball Lock (BL) – Locks manual socket against accidental disconnect.

[3] Sleeve Lock (SL) – Locks automatic socket against accidental disconnect.

Non-Standard Product       Standard Product

\* RAGCO supports the autonomy of its locations to select the best products to service their markets. Subtle variations of these specifications may exist. Contact your RAGCO affiliate for confirmation.





# ONE WAY SHUT-OFF 5 SERIES

## 5 SERIES 1/2" PLUG

FEMALE THREAD		PART NO.	FPT	DESCRIPTION
		53-5	3/8"	Steel
		55-5	1/2"	Steel
		55-5S/S		303 Stainless
		57-5	3/4"	Steel

HOSE STEM		PART NO.	I.D.	DESCRIPTION
		59-5	3/8"	Steel
		59-5B	3/8"	Brass
		60-5	1/2"	Steel
		60-5G	1/2"	Ball Check, Steel
		60-5B	1/2"	Brass
		61-5	3/4"	Steel
		61-5B	3/4"	Brass
Requires Hose Clamps				

REUSABLE HOSE CLAMP		PART NO.	I.D. X O.D.	DESCRIPTION
		PB3-5	1/4" x 1/2"	Steel
		PB5-5	1/4" x 9/16"	
		PB7-5	1/4" x 5/8"	
		PD7-5	3/8" x 5/8"	
		PD9-5	3/8" x 11/16"	
		PD11-5	3/8" x 3/4"	
		PD13-5	3/8" x 13/16"	
		PP13-5	1/2" x 13/16"	
		PP15-5	1/2" x 7/8"	
		PP17-5	1/2" x 15/16"	
PP19-5	1/2" x 1"			

PUSH-ON HOSE STEM		PART NO.	I.D.	DESCRIPTION
		71-5	3/8"	Steel
		81-5	1/2"	
		81-5B	1/2"	Brass
Hose clamps not required when used with "Push On" hose.				

MALE THREAD		PART NO.	MPT	DESCRIPTION
		50-5	1/4"	Steel
		52-5	3/8"	Steel
		52-5B		Brass
		54-5GB	1/2"	Ball Check, Brass
		54-5		Steel
		54-5G		Ball Check, Steel
		54-5B		Brass
		54-5S/S		303 Stainless
		56-5	3/4"	Steel
56-5S/S	303 Stainless			

MALE THREAD SWIVEL UNDER PRESSURE		PART NO.	MPT	DESCRIPTION
		54S-5	1/2"	Free Swivel Under Pressure, Steel

## COAXIAL PLUG/COUPLER

MALE THREAD PLUG		PART NO.	I.D.	DESCRIPTION
		54-5CA	1/2"	Steel

FEMALE THREAD COUPLER		PART NO.	I.D.	DESCRIPTION
		SV5205CA	1/2"	Steel, Safety Coupler

MALE THREAD COUPLER		PART NO.	I.D.	DESCRIPTION
		SV5305CA	1/2"	Steel, Safety Coupler
		SV5505CA	3/4"	

Non-Standard Product     
  Standard Product







# ONE WAY SHUT-OFF 5 SERIES

## 5 SERIES 1/2" 1-WAY SHUT-OFF SOCKETS

FEMALE THREAD		PART NO.	FPT	DESCRIPTION
		4015	1/4"	Brass/Steel
		BL4015		Ball Lock, Brass/Steel
		5005	3/8"	Brass/Steel
		BL5005		Ball Lock, Brass/Steel
		5005H		For Heat, Viton Seal
		5005W		For Water, Brass/SS, Buna-N Seal
		5205	1/2"	Brass/Steel
		BL5205		Ball Lock, Brass/Steel
		5205H		For Heat, Viton Seal
		5205LV		Less Valve
		5205S/S		303 Stainless
		5205W		For Water, Brass/SS, Buna-N Seal
		5405	3/4"	Brass/Steel
BL5405	Ball Lock, Brass/Steel			
5405W	For Water, Brass/SS, Buna-N Seal			

HOSE STEM		PART NO.	I.D.	DESCRIPTION
		5605	1/4"	Brass/Steel
		BL5605		Ball Lock, Brass/Steel
		5705	3/8"	Brass/Steel
		BL5705		Ball Lock, Brass/Steel
		5705H		For Heat, Viton Seal
		5805	1/2"	Brass/Steel
		BL5805		Ball Lock, Brass/Steel
		5805H		For Heat, Viton Seal
		5805HW		For Hot Water, Brass/SS, Viton Seal
		5805W		For Water, Brass/SS, Buna-N Seal
		5905		3/4"
		BL5905	Ball Lock, Brass/Steel	
		5905W	For Water, Brass/SS, Buna-N Seal	

Requires Hose Clamps

PUSH-ON		PART NO.	I.D.	DESCRIPTION
		1815	1/2"	Brass/Steel
		1815W	1/2"	For Water, Brass/SS, Buna-N Seal
		BL1815	1/2"	Ball Lock, Brass/Steel

Hose clamps not required when used with "Push On" hose.

MALE THREAD		PART NO.	MPT	DESCRIPTION
		4905	1/4"	Brass/Steel
		BL4905		Ball Lock, Brass/Steel
		5105	3/8"	Brass/Steel
		BL5105		Ball Lock, Brass/Steel
		5305	1/2"	Brass/Steel
		BL5305		Ball Lock, Brass/Steel
		5305H		For Heat, Viton Seal
		5305S/S		303 Stainless
		5305W		For Water, Brass/SS, Buna-N Seal
		5505	3/4"	Brass/Steel
BL5505	Ball Lock, Brass/Steel			

REUSABLE HOSE CLAMP		PART NO.	I.D. X O.D.	DESCRIPTION
		SD7-5	3/8" x 5/8"	Brass/Steel
		BLS7-5		Ball Lock, Brass/Steel
		SD7-5W		For Water, Brass/SS, Buna-N Seal
		SD9-5	3/8" x 11/16"	Brass/Steel
		BLS9-5		Ball Lock, Brass/Steel
		SD9-5W		For Water, Brass/SS, Buna-N Seal
		SD11-5	3/8" x 3/4"	Brass/Steel
		BLS11-5		Ball Lock, Brass/Steel
		SD13-5	3/8" x 13/16"	Brass/Steel
		BLS13-5		Ball Lock, Brass/Steel
		SP13-5	1/2" x 13/16"	Brass/Steel
		BLS13-5		Ball Lock, Brass/Steel
		SP13-5W		For Water, Brass/SS, Buna-N Seal
		SP15-5	1/2" x 7/8"	Brass/Steel
		BLS15-5		Ball Lock, Brass/Steel
		SP17-5	1/2" x 15/16"	Brass/Steel
		BLS17-5		Ball Lock, Brass/Steel
		SP19-5	1/2" x 1"	Brass/Steel
		BLS19-5		Ball Lock, Brass/Steel

 Non-Standard Product

 Standard Product

\* RAGCO supports the autonomy of its locations to select the best products to service their markets. Subtle variations of these specifications may exist. Contact your RAGCO affiliate for confirmation.



# ONE-WAY SHUT-OFF 5 SERIES

## 5 SERIES 1/2" ONE-WAY AUTOMATIC SOCKETS

FEMALE THREAD		PART NO.	FPT	DESCRIPTION	
		FM4015	1/4"	Brass	
		SL4015		Sleeve Lock, Brass	
		FM5005	3/8"	Brass	
		SL5005		Sleeve Lock, Brass	
		FM5005H		For Heat, Viton Seal, Brass	
		FM5005S		For Steam, Brass/SS, EPDM Seal	
		FM5005W		For Water, Brass/SS, Buna-N Seal	
		FM5205		1/2"	Brass
		SL5205	Sleeve Lock, Brass		
		FM5205H	For Heat, Viton Seal, Brass		
		FM5205LV	Less Valve, Brass		
		FM5205S	For Steam, Brass/SS, EPDM Seal		
		FM5205W	For Water, Brass/SS, Buna-N Seal		
		FM5405	3/4"		Brass
		SL5405			Sleeve Lock, Brass
FM5405W	For Water, Brass/SS, Buna-N Seal				

MALE THREAD		PART NO.	MPT	DESCRIPTION
		FM4905	1/4"	Brass
		SL4905		Sleeve Lock, Brass
		FM5105	3/8"	Brass
		SL5105		Sleeve Lock, Brass
		FM5305	1/2"	Brass
		SL5305		Sleeve Lock, Brass
		FM5305S		For Steam, Brass/SS, EPDM Seal
		FM5305W		For Water, Brass/SS, Buna-N Seal
		FM5505	3/4"	Brass
		SL5505		Sleeve Lock, Brass
		FM5505S		For Steam, Brass/SS, EPDM Seal

PUSH-ON HOSE STEM		PART NO.	I.D.	DESCRIPTION
		FM1815	1/2"	Brass

Hose clamps not required when used with "Push-On" hose.

HOSE STEM		PART NO.	I.D.	DESCRIPTION
		FM5605	1/4"	Brass
		SL5605		Sleeve Lock, Brass
		FM5705	3/8"	Brass
		SL5705		Sleeve Lock, Brass
		FM5705H		For Heat, Viton Seal, Brass
		FM5805	1/2"	Brass
		SL5805		Sleeve Lock, Brass
		FM5805H		For Heat, Viton Seal, Brass
		SL5805H		For Heat, Sleeve Lock, Viton Seal
		FM5805W		For Water, Brass/SS, Buna-N Seal
		FM5905		3/4"
SL5905	Sleeve Lock, Brass			

Requires Hose Clamp

REUSABLE HOSE CLAMP		PART NO.	I.D. X O.D.	DESCRIPTION
		FMSD7-5	3/8" x 5/8"	Brass
		SLSD7-5		Sleeve Lock, Brass
		FMSD7-5H		For Heat, Viton Seal, Brass
		FMSD9-5	3/8" x 11/16"	Brass
		SLSD9-5		Sleeve Lock, Brass
		FMSD11-5	3/8" x 3/4"	Brass
		SLSD11-5		Sleeve Lock, Brass
		FMSD13-5	3/8" x 13/16"	Brass
		SLSD13-5		Sleeve Lock, Brass
		FMSP13-5	1/2" x 13/16"	Brass
		SLSP13-5		Sleeve Lock, Brass
		FMSP13-5H		For Heat, Viton Seal, Brass
		FMSP15-5	1/2" x 7/8"	Brass
		SLSP15-5		Sleeve Lock, Brass
		FMSP17-5	1/2" x 15/16"	Brass
		SLSP17-5		Sleeve Lock, Brass
		FMSP19-5	1/2" x 1"	Brass
SLSP19-5	Sleeve Lock, Brass			

[1] Swivel Plug – Eliminates hose twist for applications such as blow guns, air tools, etc.

[2] Ball check plugs eliminate hose whip at disconnect by checking the rapid flow of downstream exhaust air.

[3] Ball Lock (BL) – Locks manual socket against accidental disconnect.

[4] Sleeve Lock (SL) – Locks automatic socket against accidental disconnect.



Non-Standard Product





Standard Product



# ONE-WAY SHUT-OFF 6 SERIES

## 6 SERIES 3/4" PLUGS

FEMALE THREAD		PART NO.	FPT	DESCRIPTION
		65-6	1/2"	Steel
		67-6	3/4"	
		69-6	1"	
MALE THREAD		PART NO.	MPT	DESCRIPTION
		64-6	1/2"	Steel
		66-6	3/4"	
		68-6	1"	

HOSE STEM		PART NO.	I.D.	DESCRIPTION
		70-6	1/2"	Steel Requires Hose Clamps
		71-6	3/4"	
		72-6	1"	

## 6 SERIES 3/4" ONE-WAY AUTOMATIC SOCKETS

FEMALE THREAD		PART NO.	FPT	DESCRIPTION
		FM6206	1/2"	Brass
		SL6206		Sleeve Lock, Brass
		FM6206W		For Water, Brass/SS, Buna-N Seal
		FM6406	3/4"	Brass
		SL6406		Sleeve Lock, Brass
		FM6406H		For Heat, Viton Seal
		SL6406H		For Heat, Sleeve Lock, Viton Seal, Brass
		FM6406S		For Steam, Brass/SS, EPDM Seal
		FM6406W		For Water, Brass/SS, Buna-N Seal
		FM6606	1"	Brass
		SL6606		Sleeve Lock, Brass
		FM6606W		For Water, Brass/SS, Buna-N Seal

MALE THREAD		PART NO.	MPT	DESCRIPTION
		FM6306	1/2"	Brass
		SL6306		Sleeve Lock, Brass
		FM6306S		For Steam, Brass/SS, EPDM Seal
		FM6306W	For Water, Brass/SS, Buna-N Seal	
		FM6506	3/4"	Brass
		SL6506		Sleeve Lock, Brass
		FM6506S		For Steam, Brass/SS, EPDM Seal
		FM6506W		For Water, Brass/SS, Buna-N Seal
		FM6706	1"	Brass
SL6706	Sleeve Lock, Brass			

HOSE STEM		PART NO.	MPT	DESCRIPTION
		FM6806	1/2"	Brass
		SL6806		Sleeve Lock, Brass
		FM6806W		For Water, Brass/SS, Buna-N Seal
		FM6906	3/4"	Brass
		SL6906		Sleeve Lock, Brass
		FM6906W		For Water, Brass/SS, Buna-N Seal
		FM7006	1"	Brass
		SL7006		Sleeve Lock, Brass

[1] Sleeve Lock (SL) – Locks automatic socket against accidental disconnect.

## 6 SERIES COAXIAL PLUG/COUPLER

MALE THREAD PLUG		PART NO.	I.D.	DESCRIPTION
		64-6CA	1/2"	Steel
		66-6CA	3/4"	

FEMALE THREAD COUPLER		PART NO.	I.D.	DESCRIPTION
		SV6406CA	3/4"	Steel, Safety Coupler

MALE THREAD COUPLER		PART NO.	I.D.	DESCRIPTION
		SV6506CA	3/4"	Steel, Safety Coupler

 Non-Standard Product

 Standard Product

\* RAGCO supports the autonomy of its locations to select the best products to service their markets. Subtle variations of these specifications may exist. Contact your RAGCO affiliate for confirmation.



# LN SERIES

## FEATURES:

Ragco LN Series couplings are interchangeable with Lincoln's "Long Nose" series couplings and offer quick coupling of all air-operated equipment. They are only available in 1/4" body size, air-operated equipment. They are only available in 1/4" body size, brass and steel construction.

- Locking mechanism prevents accidental coupler detachment.
- Increased air flow due to a larger air passage.
- Automatic air-check valve shuts off air instantly when uncoupled, providing leak-proof seal.
- Corrosion-resistant steel for long service life.
- Free swivel helps prevent kinking or curling of air hoses.

## OPERATION:

**Manual:** socket sleeve must be retracted to connect and disconnect

**Automatic:** Push-To connect

## SPECIFICATIONS:

**Type:** One-Way Shut-Off

**Rated Pressure:** 300 PSIG

**Temperature Range (std seals):** -40° to +250°F.

## PLUGS - 1/4"

FEMALE THREAD		PART NO.	FPT	DESCRIPTION
		LN13	1/8"	Steel
		LN11	1/4"	

MALE THREAD		PART NO.	MPT	DESCRIPTION
		LN12	1/8"	Steel
		LN10	1/4"	

## AUTOMATIC - 1/4" SOCKETS

FEMALE THREAD		PART NO.	FPT	DESCRIPTION
		LN2803	1/8"	Brass/Steel
		LN3003	1/4"	
		LN3203	3/8"	

MALE THREAD		PART NO.	MPT	DESCRIPTION
		LN2903	1/8"	Brass/Steel
		LN3103	1/4"	
		LN3303	3/8"	

HOSE STEM		PART NO.	I.D.	DESCRIPTION
		LN3603	1/4"	Brass/Steel Requires Hose Clamp
		LN3653	5/16"	
		LN3703	3/8"	

PUSH-ON HOSE STEM		PART NO.	SIZE I.D.	DESCRIPTION
		LN1513	1/4"	Brass/Steel
		LN1713	3/8"	

Hose clamps not required when used with "Push On" hose. See page 63.

REUSABLE HOSE CLAMP		PART NO.	SIZE (I.D. X O.D.)	DESCRIPTION
		LNSB3	1/4" x 1/2"	Brass/Steel
		LNSB5	1/4" x 9/16"	
		LNSB7	1/4" x 5/8"	
		LNSC5	15/16" x 9/16"	
		LNSC7	15/16" x 5/8"	
		LNSD11	3/8" x 5/8"	
		LNSD13	3/8" x 11/16"	
		LNSD7	3/8" x 3/4"	
LNSD9	3/8" x 13/16"			

 Non-Standard Product

 Standard Product





# LN SERIES CONTINUED

## MANUAL - 1/4" SOCKETS

MALE THREAD		PART NO.	MPT	DESCRIPTION
		LN2903M	1/8"	Brass/Steel
		LN3103M	1/4"	
		LN3303M	3/8"	

HOSE STEM		PART NO.	I.D.	DESCRIPTION
		LN3603M	1/4"	Brass/Steel Requires Hose Clamp
		LN3703M	3/8"	

FEMALE THREAD		PART NO.	FPT	DESCRIPTION
		LN2803M	1/8"	Brass/Steel
		LN3003M	1/4"	
		LN3203M	3/8"	

# SHD SERIES

### FEATURES:

- Engineered for speedy coupling and uncoupling. To lock - push in; To unlock - rotate sleeve 1/8 turn.
- Designed to protect against accidental uncoupling. A variety of types and sizes are available to meet specific needs.
- Standard Twist-Lock couplings are ideal for low-to-medium air flows, such as air tools.

**OPERATION:** Automatic Push-To connect; Twist-to-release

### SPECIFICATIONS:

**Temperature Range (Nitrile seal):** -10° to +165°F

**Locking Device:** Twist-Lock

**Vacuum Service:** 27 HG

**Type:** One-Way Shut-Off

**Rated Pressure:** 300 PSIG

**Materials:** Aluminum bodies and zinc-plated steel sleeves. Buna-N seals. Brass adapters.

## SHD3 SERIES - 1/2" PLUGS

FEMALE THREAD		PART NO.	FPT	DESCRIPTION
		SHD53	3/8"	Steel

HOSE STEM		PART NO.	I.D.	DESCRIPTION
		SHD59	3/8"	Steel Requires Hose Clamp
		SHD60	1/2"	

MALE THREAD		PART NO.	MPT	DESCRIPTION
		SHD50	1/4"	Steel
		SHD52	3/8"	
		SHD54	1/2"	

 Non-Standard Product

 Standard Product

\* RAGCO supports the autonomy of its locations to select the best products to service their markets. Subtle variations of these specifications may exist. Contact your RAGCO affiliate for confirmation.



# SHD SERIES

## SHD3 SERIES - 1/4" PLUGS

FEMALE THREAD		PART NO.	FPT	DESCRIPTION
		SHD13	1/8"	Steel
		SHD11	1/4"	Steel
		SHD11S/S	1/4"	303 Stainless

MALE THREAD		PART NO.	MPT	DESCRIPTION
		SHD12	1/8"	Steel
		SHD10	1/4"	Steel
		SHD10S/S	1/4"	303 Stainless

HOSE STEM		PART NO.	I.D.	DESCRIPTION
		SHD16	1/4"	Steel Requires Hose Clamp
		SHD17	3/8"	

PUSH-ON HOSE STEM		PART NO.	I.D.	DESCRIPTION
		SHD51	1/4"	Steel

Hose clamps not required when used with "Push On" hose.

## SHD5 SERIES - 1/2" AUTOMATIC SOCKETS

FEMALE THREAD		PART NO.	FPT	DESCRIPTION
		SHD4015	1/4"	Aluminum/Steel/ Brass
		SHD5005	3/8"	
		SHD5205	1/2"	
SHD5405	3/4"			

PUSH-ON HOSE STEM		PART NO.	I.D.	DESCRIPTION
		SHD1815	1/2"	Aluminum/Steel/Brass



Hose clamps not required when used with "Push On" hose.

MALE THREAD		PART NO.	MPT	DESCRIPTION
		SHD4905	1/4"	Aluminum/Steel/ Brass
		SHD5105	3/8"	
		SHD5305	1/2"	
SHD5505	3/4"			

REUABLE HOSE CLAMP		PART NO.	I.D. X O.D.	DESCRIPTION
		SHDSD75	3/8" x 5/8"	Aluminum/Steel/ Brass
		SHDSD95	3/8" x 11/16"	
		SHDSD115	3/8" x 3/4"	
		SHDSD135	3/8" x 13/16"	
		SHDSP135	1/2" x 13/16"	
		SHDSP155	1/2" x 7/8"	
		SHDSP175	1/2" x 15/16"	
SHDSP195	1/2" x 1"			

HOSE STEM		PART NO.	I.D.	DESCRIPTION
		SHD5605	1/4"	Aluminum/Steel/ Brass Requires Hose Clamp
		SHD5705	3/8"	
		SHD5805	1/2"	
		SHD5905	3/4"	

DUST PLUG		PART NO.	SIZE	DESCRIPTION
		SHD-DP	1/4"	Aluminum w/Lanyard

 Non-Standard Product     Standard Product



## SHD5 SERIES - 1/4" AUTOMATIC SOCKETS

FEMALE THREAD		PART NO.	FPT	DESCRIPTION
		SHD2803	1/8"	Aluminum/Steel/ Brass
		SHD2803S/S		303 Stainless
		SHD3003	1/4"	Aluminum/Steel/ Brass
		SHD3003-104		Aluminum/Steel/ Brass w/Silicone Seal
		SHD3003LV		Aluminum/Steel/ Brass Less Valve
		SHD3003S/S		303 Stainless
		SHD3203		3/8"
		SHD3203S/S	303 Stainless	

MALE THREAD		PART NO.	MPT	DESCRIPTION
		SHD2903	1/8"	Aluminum/Steel/ Brass
		SHD2903S/S		303 Stainless
		SHD3103	1/4"	Aluminum/Steel/ Brass
		SHD3103-104		Aluminum/Steel/ Brass w/Silicone Seal
		SHD3103S/S		303 Stainless
		SHD3303	3/8"	Aluminum/Steel/ Brass
SHD3303S/S	303 Stainless			

HOSE STEM		PART NO.	I.D.	DESCRIPTION
		SHD3603	1/4"	Aluminum/Steel/ Brass
		SHD3603S/S		303 Stainless
		SHD3653	5/16"	Aluminum/Steel/ Brass
		SHD3703	3/8"	Aluminum/Steel/ Brass
		SHD3703S/S		303 Stainless
Requires Hose Clamp				

REUABLE HOSE CLAMP		PART NO.	I.D. X O.D.	DESCRIPTION
		SHDSB33	1/4" x 1/2"	Aluminum/Steel/ Brass
		SHDSB33S/S		303 Stainless
		SHDSB53	1/4" x 9/16"	Aluminum/Steel/ Brass
		SHDSB73	1/4" x 5/8"	Aluminum/Steel/ Brass
		SHDSB73S/S		303 Stainless
		SHDSC53	5/16" x 9/16"	Aluminum/Steel/ Brass
		SHDSC73	5/16" x 5/8"	Aluminum/Steel/ Brass
		SHDSD73	3/8" x 5/8"	Aluminum/Steel/ Brass
		SHDSD93	3/8" x 11/16"	Aluminum/Steel/ Brass
		SHDSD113	3/8" x 3/4"	Aluminum/Steel/ Brass
		SHDSD133	3/8" x 13/16"	Aluminum/Steel/ Brass

PUSH-ON HOSE STEM		PART NO.	I.D.	DESCRIPTION
		SHD1513	1/4"	Aluminum/Steel/ Brass
		SHD1713	3/8"	
Hose clamps not required when used with "Push On" hose.				

Non-Standard Product

Standard Product

\* RAGCO supports the autonomy of its locations to select the best products to service their markets. Subtle variations of these specifications may exist. Contact your RAGCO affiliate for confirmation.



# FRL SERIES

**TYPE:** One-Way Shut-Off

**OPERATION:** Automatic Push-To connect; Twist-to-release

**FEATURES:**

- High flow capacity
  - 2RL flow equals that of most 3/8" couplings
  - 3RL flow equals that of most 1/2" couplings
- Ring lock
- Push-To connect
- Will not disconnect when hose is dragged on the ground
- Rotate locking sleeve approximately 20° to disconnect
- Optional seal materials available

**RATED PRESSURE:** 300 PSIG

**STANDARD MATERIALS:**

- Socket
  - Zinc-Plated Steel Body
  - Brass Socket End
  - Nickel-Plated Steel Sleeve
  - Zinc-Plated Steel Valve
  - Buna-N (Nitrile) Seal
  - Stainless Steel Spring
  - Zinc-Plated Steel Locking Ring
- Plug
  - Zinc-Plated Case-Hardened Steel

**ACCESSORIES:** Dust caps and dust plugs

## 2FRL SERIES 3/8" PLUGS

FEMALE THREAD		PART NO.	FPT	DESCRIPTION
		2L41	1/4"	Steel
		2L43	3/8"	
		2L45	1/2"	

MALE THREAD		PART NO.	MPT	DESCRIPTION
		2L38	1/8"	Steel
		2L40	1/4"	
		2L42	3/8"	
2L44	1/2"			

HOSE STEM		PART NO.	I.D.	DESCRIPTION
		2L46	1/4"	Steel Requires Hose Clamp
		2L48	3/8"	
		2L49	1/2"	



REUSABLE HOSE CLAMP		PART NO.	I.D. X O.D.	DESCRIPTION
		2LPD7	3/8" x 5/8"	Steel
		2LPD9	3/8" x 11/16"	
		2LPD11	3/8" x 3/4"	
		2LPD13	3/8" x 13/16"	
		2LPP13	1/2" x 13/16"	
		2LPP15	1/2" x 7/8"	
		2LPP17	1/2" x 15/16"	
2LPP19	1/2" x 1"			

## 3FRL SERIES 1/2" PLUGS

HOSE STEM (3FRL SERIES 1/2")		PART NO.	I.D.	DESCRIPTION
		3L58	1/4"	Steel
		3L59	3/8"	
		3L60	1/2"	
		3L60G	1/2"	Steel, Ball Check
		3L61	3/4"	Steel
		3L61G	3/4"	Steel, Ball Check
Requires Hose Clamp				

FEMALE THREAD		PART NO.	FPT	DESCRIPTION
		3L51	1/4"	Steel
		3L55	1/2"	
		3L57	3/4"	

MALE THREAD		PART NO.	MPT	DESCRIPTION
		3L50	1/4"	Steel
		3L52	3/8"	
		3L54	1/2"	
		3L56	3/4"	

 Non-Standard Product     Standard Product







## 2FRL SERIES 3/8" AUTOMATIC SOCKETS

FEMALE THREAD		PART NO.	FPT	DESCRIPTION
		2R4004	1/4"	Brass/Steel
		2R4204	3/8"	
		2R4404	1/2"	

MALE THREAD		PART NO.	MPT	DESCRIPTION
		2R4104	1/4"	Brass/Steel
		2R4304	3/8"	
		2R4504	1/2"	

HOSE STEM		PART NO.	I.D.	DESCRIPTION
		2R4604	1/4"	Brass/Steel Requires Hose Clamp
		2R4704	5/16"	
		2R4804	3/8"	
		2R4904	1/2"	

PUSH-ON HOSE STEM		PART NO.	I.D.	DESCRIPTION
		2R1714	3/8"	Brass/Steel
		2R1814	1/2"	

Hose clamps not required when used with "Push On" hose. See page 63.

REUSABLE HOSE CLAMP		PART NO.	I.D. X O.D.	DESCRIPTION
		2RSD7	3/8" x 5/8"	Brass/Steel
		2RSD9	3/8" x 11/16"	
		2RSD11	3/8" x 3/4"	
		2RSD13	3/8" x 13/16"	

## 3FRL SERIES 1/2" AUTOMATIC SOCKETS

FEMALE THREAD		PART NO.	FPT	DESCRIPTION
		3R4015	1/4"	Brass/Steel
		3R5005	3/8"	
		3R5205	1/2"	
		3R5405	3/4"	

MALE THREAD		PART NO.	MPT	DESCRIPTION
		3R4905	1/4"	Brass/Steel
		3R5105	3/8"	
		3R5305	1/2"	
		3R5505	3/4"	

PUSH-ON HOSE STEM		PART NO.	I.D.	DESCRIPTION
		3R1815	1/2"	Brass/Steel

Hose clamps not required when used with "Push-On" hose. See page 63.

HOSE STEM		PART NO.	I.D.	DESCRIPTION
		3R5605	1/4"	Brass/Steel Requires Hose Clamp
		3R5705	3/8"	
		3R5805	1/2"	
		3R5905	3/4"	

REUSABLE HOSE CLAMP		PART NO.	I.D. X O.D.	DESCRIPTION
		3RSD7	3/8" x 5/8"	Brass/Steel
		3RSD9	3/8" x 11/16"	
		3RSD11	3/8" x 3/4"	
		3RSD13	3/8" x 13/16"	
		3RSP13	1/2" x 13/16"	
		3RSP15	1/2" x 7/8"	
		3RSP17	1/2" x 15/16"	
		3RSP19	1/2" x 1"	

 Non-Standard Product

 Standard Product

\* RAGCO supports the autonomy of its locations to select the best products to service their markets. Subtle variations of these specifications may exist. Contact your RAGCO affiliate for confirmation.



# 210 SERIES

## SERIES 210 1/4" SAFETY VENT SOCKETS

FEMALE THREAD		PART NO.	FPT	DESCRIPTION
		SV210-3003	1/4"	Steel, Safety Coupler
		SV210-3203	3/8"	

MALE THREAD		PART NO.	MPT	DESCRIPTION
		SV210-3103	1/4"	Steel, Safety Coupler
		SV210-3303	3/8"	

HOSE STEM		PART NO.	I.D.	DESCRIPTION
		SV210-3603	1/4"	Steel, Safety Coupler Requires Hose Clamp
		SV210-3703	3/8"	

PUSH-ON HOSE STEM		PART NO.	I.D.	DESCRIPTION
		SV210-1513	1/4"	Steel, Safety Coupler
		SV210-1713	3/8"	

Hose clamps not required when used with "Push On" hose.

## SERIES 210 1/4" AUTOMATIC SOCKETS

FEMALE THREAD		PART NO.	FPT	DESCRIPTION
		210-2803	1/8"	Brass/Steel
		210-2803S/S	1/8"	303 Stainless
		210-3003	1/4"	Brass/Steel
		210-3003S/S	1/4"	303 Stainless
		210-3203	3/8"	Brass/Steel
		210-3203S/S	3/8"	303 Stainless

MALE THREAD		PART NO.	MPT	DESCRIPTION
		210-2903	1/8"	Brass/Steel
		210-2903S/S	1/8"	303 Stainless
		210-3103	1/4"	Brass/Steel
		210-3103S/S	1/4"	303 Stainless
		210-3303	3/8"	Brass/Steel
		210-3303S/S	3/8"	303 Stainless

HOSE STEM		PART NO.	I.D.	DESCRIPTION
		210-3603	1/4"	Brass/Steel
		210-3603S/S	1/4"	303 Stainless
		210-3653	5/16"	Brass/Steel
		210-3703	3/8"	Brass/Steel
		210-3703S/S	3/8"	303 Stainless

Requires Hose Clamp.

PUSH-ON HOSE STEM		PART NO.	I.D.	DESCRIPTION
		210-1513	1/4"	Brass/Steel
		210-1713	3/8"	

Hose clamps not required when used with "Push On" hose. See page 63.

REUSABLE HOSE CLAMP		PART NO.	I.D. X O.D.	DESCRIPTION
		210-SB3	1/4" x 1/2"	Brass/Steel
		210-SB3S/S	1/4" x 1/2"	303 Stainless
		210-SB5	1/4" x 9/16"	Brass/Steel
		210-SB7	1/4" x 5/8"	
		210-SB7S/S	1/4" x 5/8"	303 Stainless
		210-SC5	5/16" x 9/16"	Brass/Steel
		210-SC7	5/16" x 5/8"	
		210-SD7	3/8" x 5/8"	
		210-SD9	3/8" x 11/16"	
		210-SD11	3/8" x 3/4"	
		210-SD13	3/8" x 13/16"	

 Non-Standard Product

 Standard Product





# 310 SERIES

**TYPE:** One-Way Shut-Off

**RATED PRESSURE:** 300 PSIG

**OPERATION:**

**Manual** - Retract socket sleeve to connect and disconnect

**Automatic** - Push-To connect

## 310 SERIES 3/8" PLUGS

FEMALE THREAD		PART NO.	FPT	DESCRIPTION
		310-43	3/8"	Steel

MALE THREAD		PART NO.	MPT	DESCRIPTION
		310-42	3/8"	Steel

HOSE STEM		PART NO.	I.D.	DESCRIPTION
		310-48	3/8"	
		310-49	1/2"	

## 310 SERIES 3/8" AUTOMATIC SOCKETS

FEMALE THREAD		PART NO.	FPT	DESCRIPTION
		310-4004	1/4"	Brass/Steel
		310-4204	3/8"	Brass/Steel
		310-4404	1/2"	Brass/Steel

MALE THREAD		PART NO.	MPT	DESCRIPTION
		310-4104	1/4"	Brass/Steel
		310-4304	3/8"	Brass/Steel
		310-4504	1/2"	Brass/Steel

HOSE STEM		PART NO.	I.D.	DESCRIPTION	
		310-4604	1/4"		Brass/Steel Requires Hose Clamp
		310-4704	5/16"		
		310-4804	3/8"		
		310-4904	1/2"		

PUSH-ON HOSE STEM		PART NO.	I.D.	DESCRIPTION
		310-1714	3/8"	
		310-1814	1/2"	

Hose clamps not required when used with "Push-On" hose.

REUSABLE HOSE CLAMP		PART NO.	I.D. X O.D.	DESCRIPTION	
		310-SB3	1/4" x 1/2"		Brass/Steel
		310-SB5	1/4" x 9/16"		
		310-SB7	1/4" x 5/8"		
		310-SD7	3/8" x 5/8"		
		310-SD9	3/8" x 11/16"		
		310-SD11	3/8" x 3/4"		
		310-SD13	3/8" x 13/16"		

 Non-Standard Product

 Standard Product

\* RAGCO supports the autonomy of its locations to select the best products to service their markets. Subtle variations of these specifications may exist. Contact your RAGCO affiliate for confirmation.



## 310 SERIES 3/8" MANUAL SOCKETS

FEMALE THREAD		PART NO.	FPT	DESCRIPTION
		310M-4004	1/4"	Brass/Steel
		310M-4204	3/8"	
		310M-4204NP	3/8"	Brass/Steel Nickel Plated sleeve
		310M-4404	1/2"	Brass/Steel

MALE THREAD		PART NO.	MPT	DESCRIPTION
		310M-4104	1/4"	Brass/Steel
		310M-4304NP	1/4"	Brass/Steel Nickel Plated sleeve
		310M-4303	3/8"	Brass/Steel
		310M-4504	1/2"	Brass/Steel

HOSE STEM		PART NO.	I.D.	DESCRIPTION
		310M-4604	1/4"	Brass/Steel
		310M-4704	5/16"	
		310M-4804	3/8"	
		310M-4804NP	3/8"	Brass/Steel Nickel Plated sleeve
		310M-4904	1/2"	Brass/Steel
		Requires Hose Clamp.		

Non-Standard Product
  Standard Product

# FST SERIES

**TYPE:** FST Straight-Thru, no valve in either socket or plug.

**INTERCHANGEABILITY:** Standard industrial interchange design, most widely used in industry. Within each series, only sockets and plugs of the same size will couple together.

**OPERATION:** Manual – Socket sleeve must be manually retracted to connect and disconnect.

**OPTIONS:** Ball Lock (BL) – Locks socket against accidental disconnect. To connect, align ball with slot. After connection, rotate sleeve to lock. To disconnect, realign ball with slot and retract sleeve.

**SEAL COMPOUND:** Standard seals are Buna-N

**PERFORMANCE DATA FLOW:** Couplers have same inside diameter as nominal pipe.

**RATED PRESSURE:** Rated pressures as defined by ANSI/B93.2-1986, based on 4:1 Safety Factor and non-shock service.

**VACUUM SERVICE:** 27" Hg maximum

BODY SIZE	BRASS SOCKET W/ BRASS PLUG	BRASS SOCKET W/ STEEL PLUG	S/S SOCKET W/ S/S PLUG
	PSIG	PSIG	PSIG
1/8"	2500	2600	4200
1/4"	5200	5500	6700
3/8"	2700	3500	5500
1/2"	2200	2700	3000
3/4"	1700	2700	3000
1"	1700	2000	1700
1 1/4"	1700	2700	-
1 1/2"	1400	2200	-



# FST SERIES

## FST SERIES PLUGS, STRAIGHT THRU

FEMALE THREAD		PART NO.	FPT	DESCRIPTION
		12FPB	1/8"	Brass
		12FPS		303 Stainless
		25FP	1/4"	Steel
		25FPB		Brass
		25FPS	303 Stainless	
		38FP	3/8"	Steel
		38FPB		Brass
		38FPS	303 Stainless	
		50FP	1/2"	Steel
		50FPB		Brass
		50FPS	303 Stainless	
		75FP	3/4"	Steel
		75FPB		Brass
		75FPS	303 Stainless	
		100FP	1"	Steel
		100FPB		Brass
		100FPS	303 Stainless	
		125FP	1-1/4"	Steel
		125FPB		Brass
150FP	1-1/2"	Steel		
150FPB		Brass		

MALE THREAD		PART NO.	MPT	DESCRIPTION
		12MP	1/8"	Steel
		12MPB		Brass
		12MPS	1/4"	303 Stainless
		25MP		Steel
		25MPB	3/8"	Brass
		25MPS		303 Stainless
		38MP	1/2"	Steel
		38MPB		Brass
		38MPS	3/4"	303 Stainless
		50MP		Steel
		50MPB	1"	Brass
		50MPS		303 Stainless
		75MP	1-1/4"	Steel
		75MPB		Brass
		75MPS	1-1/2"	303 Stainless
		100MP		Steel
		100MPB	1"	Brass
		100MPS		303 Stainless
		125MP	1-1/4"	Steel
125MPB	Brass			
150MP	1-1/2"	Steel		
150MPB		Brass		

HOSE STEM		PART NO.	I.D.	DESCRIPTION
		25HP	1/4"	Steel
		38HPB	3/8"	Brass
75HPB	3/4"			

 Non-Standard Product

 Standard Product

\* RAGCO supports the autonomy of its locations to select the best products to service their markets. Subtle variations of these specifications may exist. Contact your RAGCO affiliate for confirmation.





# FST SERIES

## FST SERIES SOCKETS, STRAIGHT THRU

MALE THREAD		PART NO.	MPT	DESCRIPTION
		12MS	1/8"	Brass
		BL12MS		Ball Lock, Brass
		25MS	1/4"	Brass
		BL25MS		Ball Lock, Brass
		25MS-101		Brass, w/Viton Seal
		38MS	3/8"	Brass
		38MS-101		Brass, w/Viton Seal
		BL38MS		Ball Lock, Brass
		50MS	1/2"	Brass
		50MS-101		Brass, w/Viton Seal
		BL50MS		Ball Lock, Brass
		75MS	3/4"	Brass
BL75MS	Ball Lock, Brass			
100MS	1"	Brass		
BL100MS		Ball Lock, Brass		

HOSE STEM		PART NO.	I.D.	DESCRIPTION
		38HS	3/8"	Brass
		BL38HS	3/8"	Ball Lock, Brass
		50HS	1/2"	Brass
		BL50HS	1/2"	Ball Lock, Brass

Requires Hose Clamp



 Non-Standard Product     Standard Product



FEMALE THREAD		PART NO.	FPT	DESCRIPTION
		12FS	1/8"	Brass
		12FS-101		Brass, w/Viton Seal
		BL12FS		Ball Lock, Brass
		12FSS	1/8"	303 Stainless
		12FSS-101		303 Stainless, w/Viton Seal
		12FSS-103		303 Stainless, w/EPDM Seal
		BL12FSS	1/4"	Ball Lock, 303 Stainless Steel
		25FS		Brass
		25FS-101		Brass, w/Viton Seal
		BL25FS	1/4"	Ball Lock, Brass
		25FS-SWVL		Power Washer Swivel Tip, Brass
		25FSS		303 Stainless
		25FSS-101	1/4"	303 Stainless, w/Viton Seal
		25FSS-103		303 Stainless, w/EPDM Seal
		BL25FSS		Ball Lock, 303 Stainless Steel
		38FS	3/8"	Brass
		38FS-101		Brass, w/Viton Seal
		38FS-103		Brass, w/EPDM Seal
		BL38FS	3/8"	Ball Lock, Brass
		38FSS		303 Stainless
		38FSS-101		303 Stainless, w/Viton Seal
		38FSS-103	3/8"	303 Stainless, w/EPDM Seal
		BL38FSS		Ball Lock, 303 Stainless Steel
		50FS		Brass
		50FS-101	1/2"	Brass, w/Viton Seal
		50FS-103		Brass, w/EPDM Seal
		BL50FS		Ball Lock, Brass
		50FSS	1/2"	303 Stainless
		50FSS-101		303 Stainless, w/Viton Seal
		50FSS-103		303 Stainless, w/EPDM Seal
		BL50FSS	1/2"	Ball Lock, 303 Stainless Steel
		75FS		Brass
		BL75FS		Ball Lock, Brass
		75FS-101	3/4"	Brass, w/Viton Seal
		75FS-103		Brass, w/EPDM Seal
		75FS-104		Brass, w/Silicone Seal
		75FSS	3/4"	303 Stainless
		75FSS-101		303 Stainless, w/Viton Seal
		75FSS-103		303 Stainless, w/EPDM Seal
BL75FSS	3/4"	Ball Lock, 303 Stainless Steel		
100FS		Brass		
100FS-101		Brass, w/Viton Seal		
BL100FS	1"	Ball Lock, Brass		
100FSS		303 Stainless		
BL100FSS		Ball Lock, 303 Stainless Steel		
125FS	1-1/4"	Brass		
BL125FS		Ball Lock, Brass		
125FS-103		Brass, w/EPDM Seal		
150FS	1-1/2"	Brass		
BL150FS		Ball Lock, Brass		



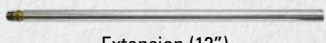

# BLOW GUNS AND ACCESSORIES

## HANDY-AIR® BLOW GUNS AND ACCESSORIES

		PART NO.	DESCRIPTION
LEVER OPERATED		BG2L-30P	Pressed – Standard Tip
		BG2L-30STP	Pressed – Safety Tip
		BG2L-30STT	Threaded – Safety Tip
		BG2L-30T	Threaded – Standard Tip
BUTTON OPERATED		BG2-30P	Pressed – Standard Tip
		BG2-30STP	Pressed – Safety Tip
		BG2-30STT	Threaded – Safety Tip
		BG2-30T	Threaded – Standard Tip
PISTOL GRIP		PG2P	Pressed – Safety Tip
		PG2T	Threaded – Safety Tip

		PART NO.	
BLOW GUN ACCESSORIES		Extension (10")	EX10DH
		Extension (12")	EX12
		High Flow Safety Nozzle	EX2
		Rubber Tip	EX2RT
		Safety Air Screen Tip	EX2ST
			EX2RT-104 w/Silicone Seal

 Non-Standard Product

 Standard Product

## BLOW GUN KITS



**BG-KIT-F1** – The versatile Ragco blow gun kit BG-KIT-F1 contains three of the most popular nozzles for industrial and automotive uses as well as a 1/4" standard plug for easy air-hose connection. This kit includes a high quality, lever-operated heavy-duty blow gun featuring a quick-disconnect coupler that allows users to switch nozzles quickly and easily. Also included are a high-flow safety nozzle, six-inch extension safety nozzle, rubber-tip nozzle and quick-connector plug for connecting the blow gun to shop air supply. The kit comes ready for hanging display in a clear clamshell package.



**BG-KIT-F2** – The Ragco BG-KIT-F2 contains five of the most popular nozzles for industrial and automotive uses. This kit includes a high quality, lever-operated heavy-duty blow gun featuring a quick disconnect coupler which allows users to switch nozzles quickly and easily. This multi-use kit also contains a high flow safety nozzle, six-inch extension safety nozzle, rubber-tip nozzle, needle-tip nozzle, and air-screen safety nozzle. For handy storage, a clear vinyl compartmented snap pouch is included.

\* RAGCO supports the autonomy of its locations to select the best products to service their markets. Subtle variations of these specifications may exist. Contact your RAGCO affiliate for confirmation.

QUICK DETACHABLE  
COUPLERS







# HOSE ACCESSORIES

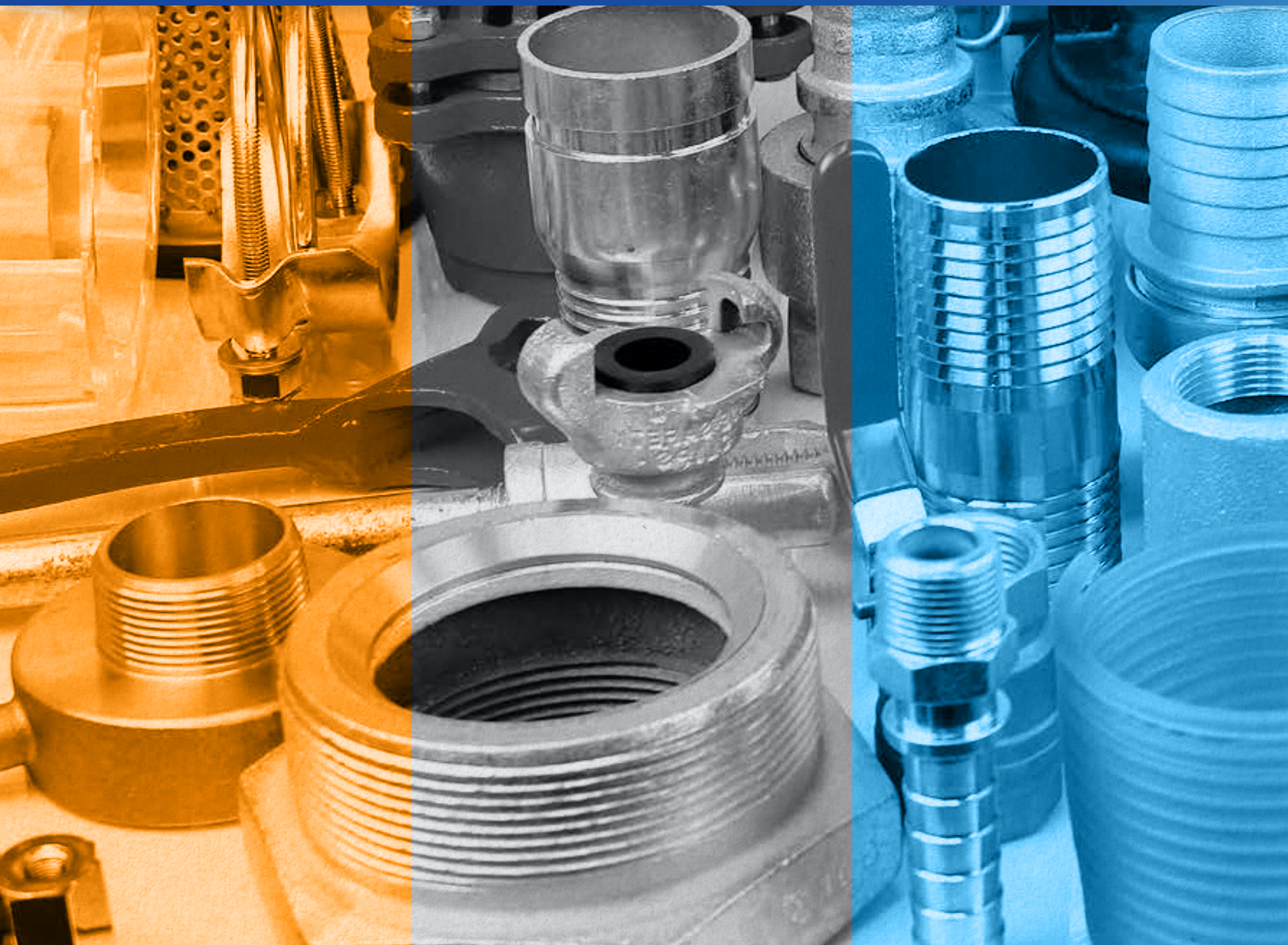



# SUCTION HOSE STRAINERS

Used on the submersed end of suction hose to prevent debris from entering the pump during operation. All threads are NPS. "Trash strainers" are square hole. For the best strainer for your application, call your local RAGCO location.

## STRAINERS

SIZE	ROUND HOLE PART #	TUBE PART #	SQUARE HOLE PART #	TOP HOLE PART #	BOTTOM HOLE PART #
1 1/2"	RHS150	TRHS150	SHS150	THS150	BHS150
2"	RHS200	TRHS200	SHS200	THS200	BHS200
2 1/2"	RHS250	CALL	CALL	CALL	CALL
3"	RHS300	TRHS300	SHS300	THS300	BHS300
4"	RHS400	CALL	SHS400	CALL	CALL
6"	RHS600	CALL	SHS600	CALL	CALL
8"	RHS800	CALL	CALL	CALL	CALL

ROUND HOLE PART



TUBE PART



SQUARE HOLE PART

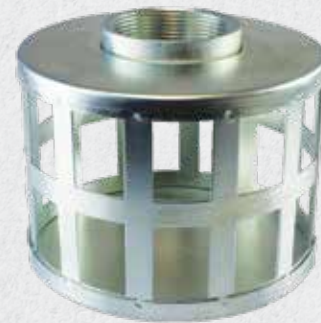

TOP HOLE PART



BOTTOM HOLE PART





# FOOT VALVES

Foot valves are used on the submersed end of the water suction hose to prevent the pump from losing its prime when it's shut down. The foot valve stops the water from draining by a closing leather-flapper gate. Each valve has a built-in strainer that prevents debris from entering during operation. All sizes have NPS threads and complete valves are painted red.

SIZE	PART #
1 1/2"	FV150
2"	FV200
2 1/2"	FV250
3"	FV300
4"	FV400
6"	FV600
8"	FV800

FOOT VALVE



# BRASS BALL VALVES

Standard full-port, quarter-turn, brass ball valves rated for 600psi WOG (up to 2") and 400psi WOG (2 1/2" thru 4"). Female NPT thread each side. Chromium-plated brass ball and Teflon® ball seat. Available with locking handles and in stainless steel.

SIZE	PART #
1/4"	BV025BF
3/8"	BV038BF
1/2"	BV050BF
3/4"	BV075BF
1"	BV100BF
1 1/4"	BV125BF
1 1/2"	BV150BF
2"	BV200BF
2 1/2"	BV250BF
3"	BV300BF
4"	BV400BF

COMPONENT	MATERIAL
Valve Body	Brass
Valve Cap	Brass
O-Ring	PTFE
Ball	Chrome Plated Brass
Stem Spacer/Gasket	PTFE
O-Ring	PTFE
Stem Spacer/Gasket	Brass
Nut	Brass
Cap	Brass
Handle	Carbon Steel

BRASS BALL VALVE



\* RAGCO supports the autonomy of its locations to select the best products to service their markets. Subtle variations of these specifications may exist. Contact your RAGCO affiliate for confirmation.



# THREADED FLANGES

Forged carbon steel, raised-face, threaded 150# ANSI flanges. Female threaded for easy installation on hose, pipe, or equipment with male threads. Available in blank, slip-on, and weldable version. Also available in stainless steel.

PART #	NOMINAL SIZE	OUTER DIAMETER	BOLT CIRCLE	HOLES	BOLT HOLE DIAMETER	THICKNESS
CSF-050	1/2"	3 1/2"	2 3/8"	4	5/8"	5/8"
CSF-075	3/4"	3 7/8"	2 3/4"	4	5/8"	5/8"
CSF-100	1"	4 1/4"	3 1/8"	4	5/8"	3/4"
CSF-125	1 1/4"	4 5/8"	3 1/2"	4	5/8"	7/8"
CSF-150	1 1/2"	5"	3 7/8"	4	5/8"	7/8"
CSF-200	2"	6"	4 3/4"	4	3/4"	1"
CSF-250	2 1/2"	7"	5 1/2"	4	3/4"	1 1/8"
CSF-300	3"	7 1/2"	6"	4	3/4"	1 1/4"
CSF-400	4"	9"	7 1/2"	8	3/4"	1 3/8"
CSF-500	5"	10"	8 1/2"	8	7/8"	1 3/8"
CSF-600	6"	11"	9 1/2"	8	7/8"	1 1/2"
CSF-800	8"	13 1/2"	11 3/4"	8	7/8"	1 3/4"
CSF-1000	10"	16"	14 1/4"	12	1"	2"
CSF-1200	12"	19"	17"	12	1"	2 1/8"

THREADED FLANGE



# WHIP CHECKS

Whip Checks are attachable safety cables for the prevention of hose whip in case of the accidental separation of a coupling or clamp device.

## HOSE-TO-TOOL

CABLE DIMENSIONS	HOSE I.D.	PART #
1/8" X 20"	1/2" - 1 1/4"	HTWS1
1/4" X 38"	1 1/2" - 3"	HTWS2

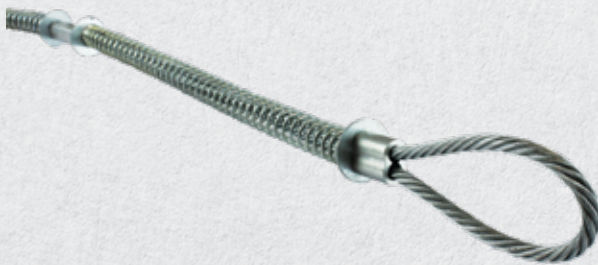

## HOSE-TO-HOSE

CABLE DIMENSIONS	HOSE I.D.	PART #
1/8" X 20"	1/2" - 1 1/4"	HHWC1
1/4" X 38"	1 1/2" - 3"	HHWC2

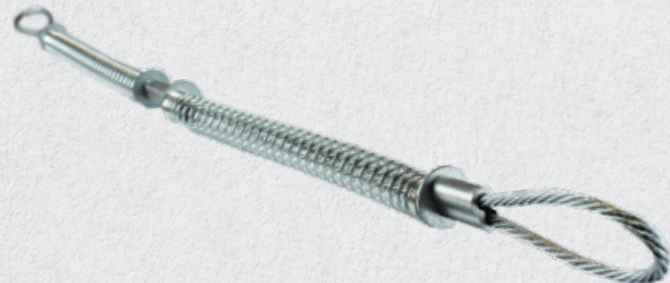



# WRENCHES

## HYDRANT WRENCHES

Part # HYD-1 is a standard and complete tool for fire hydrant operation. The pentagonal nut head is adjustable to fit hydrant valves to 1-3/4" for on/off operation. The head also operates pin-lug or rocker-lug connections from 1-1/2" to 6"

Part # HYD-3 is lighter in weight than the HYD-1 with the same adjustable features. Fits 1-3/4" pentagonal nuts. The head will operate hydrant cap and adapter-pin or rocker lugs. Handle is plated.

HYDRANT WRENCH TYPE	PART #
Standard	HYD-1
Lightweight	HYD-3

### STANDARD HYDRANT



### LIGHTWEIGHT HYDRANT

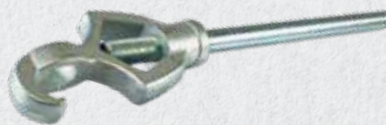

## SPANNER WRENCHES

Made from ductile iron with easy-grip handle, contour head to fit the coupling curve and a special round hole to engage the pin-lug. Dual diameter available for 2" x 2 1/2" size. Universal spanner wrench is painted red complete with pry bar end and gas cock shut off/on feature. Other end used as pin-lug or rocker-lug wrenching.

SPANNER WRENCH SIZE	PART #
1 1/2"	SW150
2"	SW200
2" X 2 1/2" *	SW2025
2 1/2"	SW250
3"	SW300
4"	SW400
Universal	US-1

### STANDARD SPANNER



### DUAL DIAMETER SPANNER



### UNIVERSAL SPANNER



\* RAGCO supports the autonomy of its locations to select the best products to service their markets. Subtle variations of these specifications may exist. Contact your RAGCO affiliate for confirmation.



# NOZZLES

## FOG NOZZLES

Plastic nozzles are made of high-impact bright red plastic with corrosion-resistant metal parts. Brass nozzles are high-quality heavy brass. These nozzles allow for straight stream or fog spray pattern in industrial, utility or commercial use. All sizes, for use at 100 PSI, water only at 70°F.

### BRASS FOG NOZZLE



### PLASTIC FOG NOZZLE



### BRASS FOG NOZZLE

THREAD SIZE	THREAD TYPE	PART #
1 1/2"	NPS	FN150B
1 1/2"	NST	FN150BNST
2"	NPS	FN200B
2 1/2"	NPS	FN250BNST
2 1/2"	NST	FN250BNST

### PLASTIC FOG NOZZLE

THREAD SIZE	THREAD TYPE	PART #
1 1/2"	NPS	FN150
1 1/2"	NST	FN150NST

## TWIST GARDEN-HOSE NOZZLE

Features all-brass valve stem, four nozzle openings for full flow, and replaceable front and rear O-ring seals for leakproof shut-off. Precise tip angle eliminates side spray. Adjustable from fine spray to needle stream to heavy rinse. Heavy-duty, solid brass construction. Roughly 4" length.

THREAD SIZE	THREAD TYPE	PART #
3/4"	GHT	TGHN



## INSULATED PISTOL-GRIP GARDEN-HOSE NOZZLE

Insulated for use with hot or cold water. Inlet is female garden-hose thread. Tip is male garden-hose thread as an easy combination with other attachments.

THREAD SIZE	THREAD TYPE	PART #
3/4"	GHT	IPGN





# NOZZLES CONTINUED

## TAPERED (SUICIDE) NOZZLES

Made from cast brass with satin finish. Orifice tip sizes are standard. All sizes, for use at 100 psi, water only at 70°F.

### TAPERED NOZZLE



THREAD SIZE	THREAD TYPE	NOZZLE LENGTH	PART #
3/4"	GHT	6"	BN075GHT
3/4"	NPSH	6"	BN075
1"	NPSH	8"	BN100
1 1/4"	NPSH	9"	BN125
1 1/2"	NPSH	10"	BN150
1 1/2"	NST	10"	BN150NST
2"	NPSH	12"	BN200
2 1/2"	NPSH	CALL	BN250
2 1/2"	NST	CALL	BN250NST

# BRASS PIN-LUG HYDRANT ADAPTERS

For industrial utility and fire department applications, these adapters allow easy connections from hydrant to smaller size hose. Made of heavy-duty cast brass with satin finish. Pin-lug style. All threads are V cut. Replacement gasket part # HAG250. Hex adapters and other configurations not shown are available. Please call for more information.

### HYDRANT ADAPTER



FEMALE SIDE	MALE SIDE	PART #
1 1/2" NPT	1 1/2" NST	HAB1516
1 1/2" NST	1 1/2" NPT	HAB1615
2" NPT	1 1/2" NST	HAB2016
2 1/2" NST	3/4" GHT	HAB075
2 1/2" NST	3/4" NPSM	HAB076
2 1/2" NST	1" NPSM	HAB100
2 1/2" NST	1 1/2" NPSM	HAB150
2 1/2" NST	1 1/2" NPT	HAB150NPT
2 1/2" NST	1 1/2" NST	HAB150NST
2 1/2" NST	2" NPSM	HAB200
2 1/2" NST	2" NPT	HAB200NPT
2 1/2" NST	2 1/2" NPT	HAB250NPT

\* RAGCO supports the autonomy of its locations to select the best products to service their markets. Subtle variations of these specifications may exist. Contact your RAGCO affiliate for confirmation.



# HOSE CLAMPS

## WORM-GEAR CLAMPS

Engineered with efficient three-piece construction for tough installation. No spot welds to corrode material, and edges are rounded to protect the hose. Easily installed with a screwdriver, nut driver, or socket wrench. Available in partial- or all-stainless construction or in "quick release" style.

CLAMP NUMBER	BAND WIDTH	DIAMETER MIN	DIAMETER MAX
#6	1/2"	3/8"	7/8"
#8	1/2"	7/16"	1"
#10	1/2"	9/16"	1-1/16"
#12	1/2"	9/16"	1-1/4"
#16	1/2"	11/16"	1-1/2"
#20	1/2"	3/4"	1-3/4"
#24	1/2"	1-1/16"	2"
#28	1/2"	1-5/16"	2-1/4"
#32	1/2"	1-9/16"	2-1/2"
#36	1/2"	1-13/16"	2-3/4"
#40	1/2"	2-1/16"	3"
#44	1/2"	2-5/16"	3-1/4"
#48	1/2"	2-9/16"	3-1/2"
#52	1/2"	2-13/16"	3-3/4"
#56	1/2"	3-1/16"	4"
#60	1/2"	3-5/16"	4-1/4"
#64	1/2"	3-9/16"	4-1/2"
#72	1/2"	4-1/16"	5"
#80	1/2"	4-5/8"	5-1/2"
#88	1/2"	4-3/32"	6"
#96	1/2"	4-1/2"	6-1/2"
#104	1/2"	5"	7"
#116	1/2"	5-3/4"	7-1/2"



## LARGE DIAMETER WORM-GEAR CLAMPS

Similar design to worm-gear clamps for larger diameter applications. Usually open-ended for easy installation.

CLAMP NUMBER	BAND WIDTH	DIAMETER MIN	DIAMETER MAX
#128	1/2"	1-3/4"	8-9/16"
#152	1/2"	2"	10"
#188	1/2"	2-1/16"	12-5/16"
#216	1/2"	10-3/16"	14"
#248	1/2"	1-3/4"	16"
#312	1/2"	1-7/8"	20"





# HOSE CLAMPS CONTINUED

## T-BOLT CLAMPS

T-Bolt clamps are a step up from basic worm-gear clamps. The principle is the same with a 3/4" band providing 360 degrees of sealing surface, and they are particularly useful in high-torque applications. Note: The T-Bolt clamp's design allows a smaller size range than other styles of field clamp. Please choose size carefully.

CLAMP NUMBER	SIZE RANGE (INCHES)	CLAMP NUMBER	SIZE RANGE (INCHES)	CLAMP NUMBER	SIZE RANGE (INCHES)
TBCS-21	1.31 X 1.56	TBCS-53	3.31 X 3.62	TBCS-93	5.81 X 6.12
TBCS-25	1.56 X 1.81	TBCS-57	3.56 X 3.87	TBCS-97	6.06 X 6.37
TBCS-27	1.69 X 1.94	TBCS-58	3.63 X 3.94	TBCS-101	6.31 X 6.62
TBCS-29	1.81 X 2.06	TBCS-61	3.81 X 4.12	TBCS-105	6.56 X 6.87
TBCS-33	2.06 X 2.31	TBCS-65	4.06 X 4.37	TBCS-109	6.81 X 7.12
TBCS-35	2.19 X 2.50	TBCS-69	4.31 X 4.62	TBCS-113	7.06 X 7.37
TBCS-37	2.31 X 2.62	TBCS-73	4.56 X 4.87	TBCS-117	7.31 X 7.62
TBCS-38	2.38 X 2.69	TBCS-77	4.81 X 5.12	TBCS-121	7.56 X 7.87
TBCS-39	2.44 X 2.75	TBCS-81	5.06 X 5.37	TBCS-125	7.81 X 8.12
TBCS-41	2.56 X 2.87	TBCS-85	5.31 X 5.62	TBCS-129	8.06 X 8.37
TBCS-43	2.69 X 3.00	TBCS-89	5.56 X 5.87	TBCS-139	8.69 X 9.19
TBCS-45	2.81 X 3.12	TBCS-93	5.81 X 6.12	TBCS-170	10.63 X 11.13
TBCS-47	2.94 X 3.25	TBCS-97	6.06 X 6.37	TBCS-202	12.63 X 13.13
TBCS-49	3.06 X 3.37				



## PUNCH-LOK CLAMPS

Preformed and ready for application to be installed with a center-punch tool. Diameter displayed is the actual diameter of the clamp. Choose the correct clamp for your application by selecting the next diameter over the outside diameter of your hose.

CLAMP NUMBER SS	CLAMP NUMBER GALV.	BAND WIDTH	DIAMETER
P-311S	P-311	3/8"	1-3/8"
P-3S	P-3	5/8"	13/16"
P-5S	P-5	5/8"	1-1/4"
P-6S	P-6	5/8"	1-1/2"
P-7S	P-7	5/8"	1-3/4"
P-8S	P-8	5/8"	2"
P-10S	P-10	5/8"	2-1/2"
P-12S	P-12	5/8"	3"
P-16S	P-16	5/8"	4"
P-20S	P-20	5/8"	5"
P-24S	P-24	5/8"	6"
P-28S	P-28	5/8"	7"
P-32S	P-32	5/8"	8"

### PUNCH-LOK CLAMP



### OPEN-ENDED PUNCH-LOK CLAMP



\* RAGCO supports the autonomy of its locations to select the best products to service their markets. Subtle variations of these specifications may exist. Contact your RAGCO affiliate for confirmation.



# HOSE CLAMPS CONTINUED

## J-LOK CLAMPS

For use with special air-actuated and mechanical machines. Not for use with center-punch tools.

CLAMP NUMBER	DIAMETER
PJ-201	13/16"
PJ-202	1-3/8"
PJ-206	1-3/4"
PJ-207	2"
PJ-208	2-1/4"
PJ-209	2-1/2"
PJ-210	2-3/4"
PJ-211	3"

CLAMP NUMBER	DIAMETER
PJ-212	3-1/2"
PJ-213	4"
PJ-214	4-1/2"
PJ-215	5"
PJ-216	6"
PJ-218	7"
PJ-219	8"



## HEAVY DUTY DOUBLE-BOLT CLAMPS

Heavy duty clamps with two bolts 180° and saddles for demanding applications.

CLAMP NUMBER	DIAMETER MIN	DIAMETER MAX
400	3-7/16"	3-13/16"
463	4"	4-3/8"
525	4-1/2"	5-1/8"
550	4-11/16"	5-15/16"
600	5-1/2"	5-15/16"
675	6-1/8"	6-7/8"
769	6-7/8"	7-3/8"
818	7-3/8"	8"
875	8-1/4"	8-7/8"
988	8-15/16"	9-3/4"
1125	9-5/16"	11-3/8"
1275	11-3/16"	13"





# HOSE CLAMPS CONTINUED

## DOUBLE-BOLT CORRUGATED HOSE CLAMPS

Clamps (for corrugated hose) manufactured in either clockwise (right hand) or counter clockwise (left hand) design, the spiral double-bolt clamp fits between the convolutions on a corrugated hose. When fully tightened, the wire secures the full circumference of the outside hose wall—not the convolutions—for a safe, economical and efficient securing method. Consult hose manufacturer for correct convolution direction. Direction of clamp spiral and hose convolutions are the same. \*Specify clockwise (CW) or counterclockwise (CCW).

CLAMP NUMBER	HOSE SIZE
SDB150	1 ½"
SDB200	2"
SDB250	2 ½"
SDB300	3"
SDB400	4"
SDB500	5"
SDB600	6"
SDB800	8"
SDB1000	10"
SDB1200	12"







# PUMPS





## ADVANTAGES AND CHARACTERISTICS

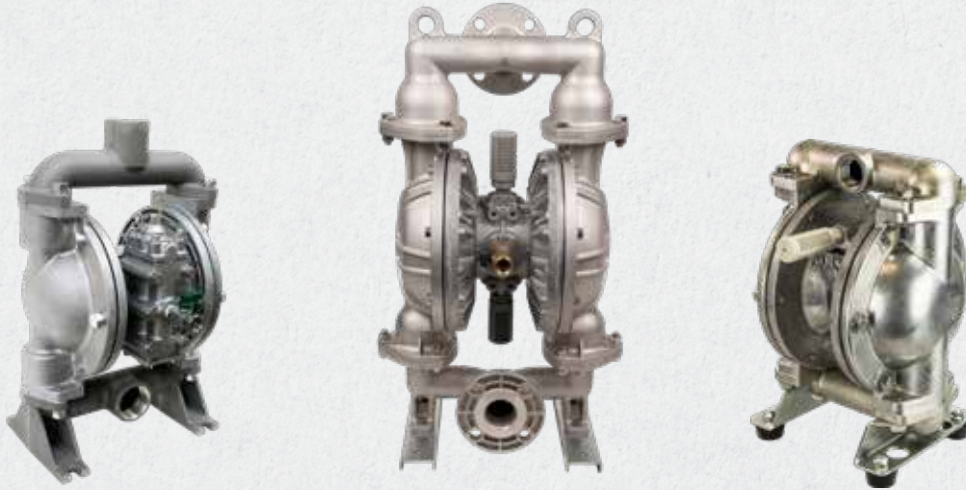

- 1. Handle a wide variety of fluids with high solids content:** No close-fitting or rotating parts so liquid with high solids content and/or size can be easily pumped.
- 2. Self Priming:** The RAGCO pump design (incorporating internal check valves) provides high suction lift even at dry start-up and with heavier fluids.
- 3. Ability to Run Dry:** No close-fitting or sliding parts are at risk—the pump can run dry without damage.
- 4. Variable Flow Rate and Discharge Pressure:** RAGCO pumps will run at any setting within their operating range simply by adjusting the air inlet pressure and system conditions. One pump can fit a broad spectrum of applications.
- 5. Portable/Simple Installation:** RAGCO pumps transport easily to the application site. Simply connect an air supply, attach fluid connections, and the pump is ready to perform. There are no complex controls to install or operate.
- 6. Dead Head:** Because the discharge pressure can never exceed air inlet pressure, the discharge line can be closed with no damage or wear. The pump will simply slow down and stop.
- 7. Shear Sensitive:** The gentle nature and minimal parts contact with the liquid make RAGCO pumps an excellent choice for shear-sensitive fluids.
- 8. Safe Operation:** Powered by compressed air, RAGCO pumps are intrinsically safe.
- 9. Submersible:** If external components are compatible, RAGCO pumps can be submerged in liquids by simply running the exhaust line above the liquid level.
- 10. Pumping Efficiency Remains Constant:** There are no rotors, gears, or pistons, which wear over time and lead to the gradual decline in performance/flow rate.



# RAPID PUMPS

## 1/2" RG-15 METAL PUMP

The RG-15 Series Metal Pump is designed to provide maximum performance, while maintaining the reliability that you've grown accustomed to from RAGCO. These 1/2" pumps are perfect for spraying and dispensing applications, particularly when on-and-off cycling reliability is critical. Constructed of aluminum, it is available with Buna N, TPO, and PTFE elastomers.

With our new Step Spool (S-Spool), RG-15 uses up to 30% less air than the competition. Maintenance is also simplified with fewer wearing parts.

Suitable for lubricants, diesel, dispensing, spraying, automotive fluid transfer, waste oil, and evacuation.



### SPECIFICATIONS

<b>Maximum Flow Rate:</b>	15 GPM
<b>Port Size:</b>	1/2" Female
<b>Air Supply Pressure:</b>	30-100 PSI
<b>Liquid Temperature:</b>	32-212°F
<b>Max. Air Consumption:</b>	18 SCFM
<b>Air Inlet:</b>	3/8" Female NPT
<b>Dry Suction Lift:</b>	15'
<b>NPT Dimensions:</b>	7.32" L x 7.64" W x 10.4" H
<b>Body Material:</b>	Aluminum (ADC 12)
<b>Weight:</b>	11.9 lbs.
<b>Diaphragm Materials:</b>	Buna N/TPO/PTFE

### FEATURES:

- No Lubrication Required
- Stall-Free / S-Spool Design
- Fewer Wearing Parts
- Ease of Repair—Quick Teardown / Rebuild
- 30% Less Air Consumption Over Competitors' Pumps
- Perfect for Dispensing and Spraying Applications
- Critical On/Off Cycling
- Optional Drum Pump Conversion Kits Available!

### ACCESSORIES:

- RG-1A Filter Regulator
- Air Motor and Liquid Kits

\* RAGCO supports the autonomy of its locations to select the best products to service their markets. Subtle variations of these specifications may exist. Contact your RAGCO affiliate for confirmation.



## 1/2" RG-15 METAL DRUM PUMP

Everything that the RG-15 Metal Pump has to offer, but available as a drum pump! RAGCO Air-Powered Double Diaphragm Pumps have distinct design advantages that make them very versatile and cost-effective drum pumps.

It's suitable for lubricants, diesel, dispensing, spraying, automotive fluid transfer, waste oil, and evacuation.



### SPECIFICATIONS

<b>Maximum Flow Rate:</b>	15 GPM
<b>Port Size:</b>	1/2" Female
<b>Air Supply Pressure:</b>	30-100 PSI
<b>Liquid Temperature:</b>	32-212°F
<b>Max. Air Consumption:</b>	18 SCFM
<b>Air Inlet:</b>	3/8" Female NPT
<b>Dry Suction Lift:</b>	15'
<b>NPT Dimensions:</b>	7.32" L x 7.64" W x 10.4" H
<b>Body Material:</b>	Aluminum (ADC 12)
<b>Weight:</b>	11.9 lbs.
<b>Diaphragm Materials:</b>	Buna N/TPO/PTFE

### FEATURES:

- No Lubrication Required
- Stall-Free / S-Spool Design
- Fewer Wearing Parts
- Ease of Repair—Quick Teardown / Rebuild
- 30% Less Air Consumption Over Competitors' Pumps
- Perfect for Dispensing and Spraying Applications
- Critical On/Off Cycling

### ACCESSORIES:

- RG-1A Filter Regulator
- Air Motor and Liquid Kits



# RAPID PUMPS

## 1/2" RG-15 PLASTIC PUMP

The RG-15 Series Plastic Pumps are designed to provide maximum performance, while maintaining the reliability that you've grown accustomed to from RAGCO. These 1/2" pumps are perfect for spraying and dispensing applications, particularly when on-and-off cycling reliability is critical. Constructed in Polypropylene, this pump is available with Buna N, TPO, and PTFE elastomers.

Suitable for lubricants, diesel, dispensing, spraying, automotive fluid transfer, waste oil, and evacuation.



### FEATURES:

- Stall Free
- Fewer Wearing Parts
- Ease of Repair—Quick Teardown / Rebuild
- Perfect for Dispensing and Spraying Applications
- Critical On/Off Cycling

SPECIFICATIONS	
<b>Maximum Flow Rate:</b>	15 GPM
<b>Port Size:</b>	1/2" Female
<b>Air Supply Pressure:</b>	20-100 PSI
<b>Liquid Temperature:</b>	32-212°F
<b>Max. Air Consumption:</b>	9 SCFM
<b>Air Inlet:</b>	1/4" Female NPT
<b>Dry Suction Lift:</b>	10'
<b>NPT Dimensions:</b>	9.68"W x 11.69" H
<b>Body Material:</b>	Polypropylene
<b>Weight</b>	9 lbs.
<b>Diaphragm Materials:</b>	Buna N/TPO/PTFE

### ACCESSORIES:

- RG-1A Filter Regulator
- Air Motor and Liquid Kits



## 1" RG-25 METAL PUMP

The new RG-25 Metal Pump has been specifically engineered with reduced parts, while ensuring maximum performance and unmatched reliability in a variety of applications.

The RG-25 is truly a non-lubricated, air distribution system with no messy grease to pre-pack. The main air valve is comprised of a patented, carbon-filled Ekonol® seal ring system that is designed to be non-stalling for reliability, while our staged exhaust design allows for an ice-free operation. All of these advanced features enable the RG-25 to use 20% less air than other brands, providing superior efficiency and exceptional durability.

Ideal for waste oil, slurries, solvents, automotive fluids, inks, paints, and more!



### SPECIFICATIONS

<b>Maximum Flow Rate:</b>	37 GPM
<b>Port Size:</b>	1" Female
<b>Air Supply Pressure:</b>	30-100 PSI
<b>Liquid Temperature:</b>	32-180°F
<b>Max. Air Consumption:</b>	30 SCFM
<b>Max. Size Solid:</b>	1/8"
<b>Air Inlet:</b>	3/8" Female NPT
<b>NPT Dimensions:</b>	8.25" L x 8.5" W x 12.4" H
<b>Body Material:</b>	Aluminum (ADC 12)
<b>Weight:</b>	17.4 lbs.
<b>Diaphragm Materials:</b>	Buna N/Hytrel®/TPO/PTFE

### FEATURES:

- No Lubrication Required
- Maintenance-Free Air Distribution System
- Stall-Free / Ice-Free Operation
- Fewer Wearing Parts
- Ease of Repair—Quick Teardown / Rebuild
- 20% Less Air Consumption
- Drop-in Replacement for Other Brands
- Graphite Filled Ekonol Seal Rings (Lube Free)
- Independent, Non-Lubricated Piloting System

### ACCESSORIES:

- RG-3A Filter Regulator
- Air Motor and Liquid Kits
- Base Cushion Kit
- Pulsation Dampener

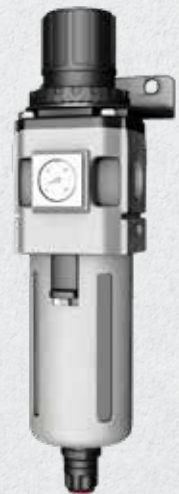



# RAPID PUMPS

## 1-1/2" RG-32 METAL PUMP

The RG-32 makes converting to a RAGCO pump easy! The 1-1/2" inlet and 1-1/4" outlet matches up dimensionally with old competing brands' designs. The re-piping issue has been solved!

Suitable for lubricants, diesel, dispensing, spraying, automotive fluid transfer, waste oil, and evacuation.



### SPECIFICATIONS

<b>Maximum Flow Rate:</b>	50.2 GPM
<b>Port Size:</b>	1-1/2" Intake / 1-1/4" Discharge
<b>Air Supply Pressure:</b>	30-100 PSI
<b>Liquid Temperature:</b>	180-248°F
<b>Max. Size Solid:</b>	1/8" (3 mm)
<b>Air Inlet:</b>	3/8" Female NPT
<b>NPT Dimensions:</b>	11.18"W x 16.87"H
<b>Body Material:</b>	Aluminum (ADC 12)
<b>Weight:</b>	16.5 lbs.
<b>Diaphragm Materials:</b>	Buna N/Hytrel®/TPO/PTFE
<b>Diaphragm Materials:</b>	Buna N/TPO/PTFE

### FEATURES:

- No Lubrication Required
- Maintenance-Free Air Distribution System
- Stall-Free / Ice-Free Operation
- Ease of Repair—Quick Teardown / Rebuild
- Drop-in Replacement for Other Brands

### ACCESSORIES:

- RG-3A Filter Regulator
- Air Motor and Liquid Kits
- Pulsation Dampener

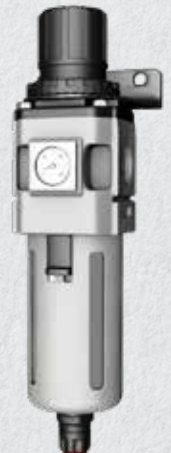

\* RAGCO supports the autonomy of its locations to select the best products to service their markets. Subtle variations of these specifications may exist. Contact your RAGCO affiliate for confirmation.



## 2" RG-50 METAL PUMP

The RG-50 is designed for use in process-type applications including filter press, high pressure, extended deadheading, long runs of discharge pipe, and where air consumption is critical. Air power is conserved by actuating the air valve using a mechanical linkage instead of relying on air pressure. Air power is reduced versus a standard air-actuated valve, providing higher pump efficiency.

Suitable for lubricants, diesel, dispensing, spraying, automotive fluid transfer, waste oil, and evacuation.



### SPECIFICATIONS

<b>Maximum Flow Rate:</b>	164 GPM
<b>Port Size:</b>	2" ANSI
<b>Air Supply Pressure:</b>	20-100 PSI
<b>Liquid Temperature:</b>	180-248°F
<b>Max. Air Consumption:</b>	105 SCFM
<b>Max. Size Solid:</b>	5/16" (8 mm)
<b>Air Inlet:</b>	3/4" Female NPT
<b>NPT Dimensions:</b>	18.63"W x 32.32"H
<b>Body Material:</b>	Aluminum (ADC 12)
<b>Weight:</b>	92 lbs.
<b>Diaphragm Materials:</b>	Neoprene/Buna-N/EPDM/ Hytrel®/ TPO/Viton®/PTFE

### FEATURES:

- Maintenance-Free Air Distribution System
- Stall-Free / Ice-Free Operation
- Ease of Repair—Quick Teardown / Rebuild
- Lower Air Consumption
- Graphite-Filled Seal Rings—Longer Life, Better Wear
- Mechanically-Actuated Air Motor

### ACCESSORIES:

- RG-3A Filter Regulator
- Air Motor and Liquid Kits
- Pulsation Dampener

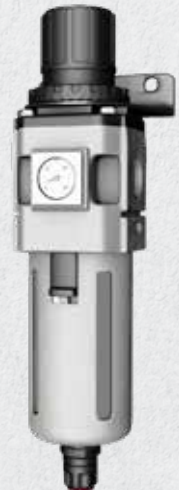



# RAPID ACCESSORIES

## AIR MOTOR AND LIQUID KITS

RAGCO Liquid and Air Motor kits are conveniently packaged and available for easy maintenance on your pump.



## FILTER REGULATOR

Protecting your valuable investment at the end of your air lines has never been so easy. RAGCO filter/regulators provide precise air inlet pressure control and prevent air-line contaminants from reaching your pump.



## PULSATION DAMPENERS

RAGCO Pulsation Dampeners greatly reduce pressure fluctuations in fluid flow when mounted close to the pump.



## DRUM PUMP KIT

Have a RAGCO RG-15 pump, but need it to be a drum pump? Not a problem. RAGCO offers drum pump kits for easy conversions.

Drum Pump Kit includes the following:

- Bung Adapter
- Coupling
- Nipple
- 3/4" Pipe
- Thumb Screw







# RESOURCES





# GLOSSARY OF TERMS A-B

**Abrasion:** external damage to a hose assembly caused by its being rubbed by a foreign object; a wearing away by friction.

**Abrasion tester:** a machine for determining the quantity of material worn away by friction under specified conditions.

**Absorption:** regarding hose, the process of taking in fluid. Hose materials are often compared with regard to relative rates and total amounts of absorption as they pertain to specific fluids.

**Accelerated life test:** a method designed to approximate in a short time the deteriorating effects obtained under normal service conditions.

**Acid resistant:** having the ability to withstand the action of identified acids within specified limits of concentration and temperature.

**Adapter, Adaptor:** 1) fittings of various sizes and materials used to change an end fitting from one type to another type or one size to another. (i.e., a male JIC to male pipe adapter is often attached to a female JIC to create a male end union fitting); 2) the grooved portion of a cam & groove coupling.

**Adhesion:** the strength of bond between cured rubber surfaces or between a cured rubber surface and a non-rubber surface.

**Adhesion failure:** (1) the separation of two bonded surfaces at an interface by a force less than specified in a test method; (2) the separation of two adjoining surfaces due to service conditions.

**Adhesive:** a material which, when applied, will cause two surfaces to adhere.

**Aerostatic testing:** see Pneumatic testing.

**Afterglow:** in fire resistance testing, the red glow persisting after extinction of the flame.

**Algaflon®:** a registered trademark of Ausimont USA. See PTFE.

**Air oven aging:** a means of accelerating a change in the physical properties of rubber compounds by exposing them to the action of air at an elevated temperature at atmospheric pressure.

**Air under water testing:** see Pneumatic testing.

**Ambient temperature:** the temperature of the atmosphere or medium surrounding an object under consideration.

**Ambient/atmospheric conditions:** the surrounding conditions, such as temperature, pressure, and corrosion, to which a hose assembly is exposed.

**Amplitude of vibrations and/or lateral movement:** the distance a hose assembly deflects laterally to one side from its normal position, when this deflection occurs on both sides of the normal hose centerline.

**Anchor:** a restraint applied to eliminate motion and restrain forces.

**Angular displacement:** displacement of two parts defined by an angle.

**Annular:** refers to the convolutions on a hose that are a series of complete circles or rings located at right angles to the longitudinal axis of the hose (sometimes referred to as "bellows").

**ANSI:** American National Standards Institute.

**Antistatic:** see Static conductive.

**Application working pressure:** unique to customer's application. See pressure, working.

**Application:** the service conditions that determine how a hose assembly will be used.

**Armor:** a protective cover slid over and affixed to a hose assembly; used to prevent over bending or for the purpose of protecting hose from severe external environmental conditions such as hot materials, abrasion or traffic.

**Assembly:** a general term referring to any hose coupled with end fittings of any style attached to one or both ends.

**ASTM:** American Society for Testing and Materials.

**Attachment:** the method of securing an end fitting to a hose (e.g., banding, crimping, swaging, or screw-together-2 piece or 3 piece-style-reusable fittings).

**Autoclave:** an apparatus using superheated high pressure steam for sterilization, vulcanization and other processes.

**Axial movement:** compression or elongation along the longitudinal axis.

**Backing:** a soft rubber layer between a hose tube and/or cover and carcass to provide adhesion.

**Band:** (1) a metal ring that is welded, shrunk, or cast on the outer surface of a hose nipple or fitting; (2) a thin strip of metal used as a non-bolted. See Hose clamp.

**Barb:** the portion of a fitting (coupling) that is inserted into the hose, usually comprised of two or more radial serrations or ridges designed to form a redundant seal between the hose and fitting.

**Barbed and ferrule fitting:** a two-piece hose fitting comprised of a barbed insert (nipple), normally with peripheral ridges or backward-slanted barbs, for inserting into a hose and a ferrule, usually crimped or swaged.

**Basket weave:** a braid pattern in which the plaits of wire alternately cross over and under two strands (two over-two under).

**Bench marks:** marks of known separation applied to a specimen used to measure strain (elongation of specimen).

**Bench test:** a modified service test in which the service conditions are approximated in the laboratory.

**Bend radius:** the radius of a bent section of hose measured to the innermost surface of the curved portion.

**Bend radius, minimum:** the smallest radius at which a hose can be used. For Metal Hose: -the radius of a bend measured to the hose centerline, as recommended by the manufacturer.

**Bend radius, dynamic:** the radius at which constant or continuous flexing occurs.

**Bending force:** an amount of stress required to induce bending around a specified radius and hence, a



# GLOSSARY OF TERMS B-C

measure of stiffness. Bend radius, static: the smallest fixed radius at which a hose can be subjected.

**Bevel seat fitting:** see Fitting, Bevel Seat.

**Beverly shear:** hand or pneumatically operated, table mounted, metal cutting shear used to cut medium pressure hose of PTFE.

**Billet:** (1) a compressed cylinder of PTFE resin, from which raw tubing is extruded. Also called a preform. (2) a solid piece of material from which a fitting is manufactured.

**Bleeding:** surface exudation. See Bloom.

**Blister:** a raised area on the surface or a separation between layers usually creating a void or air-filled space in a vulcanized article.

**Bloom:** a discoloration or change in appearance of the surface of a rubber product caused by the migration of a liquid or solid to the surface, (e.g. sulfur bloom, wax bloom). Not to be confused with dust on the surface from external sources.

**Blow out force:** the force generated from the internal pressure attempting to push the fitting from the hose.

**Body wire:** normally a round or flat wire helix embedded in the hose wall to increase strength or to resist collapse.

**Bolt hole circle:** a circle on the flange face around which the center of the bolt holes are distributed.

**Bore:** (1) an internal cylindrical passageway, as of a tube, hose or pipe; (2) the internal diameter of a tube, hose, or pipe.

**Bowl:** (1) the exterior shell of an expansion ring type coupling; (2) the larger internal diameter of the internal portion of a ferrule.

**Braid:** the woven portion of a hose used as reinforcement to increase pressure rating and add hoop strength. Various materials such as polyester, cotton or metal wire are used. A hose may have one or more braids, outside or between layers of hose material.

**Braid angle:** the angle developed at the intersection of a braid strand and a line parallel to the axis of a hose.

**Braid coverage:** the relative amount of braid material covering a hose expressed as a percent.

**Braid make up:** description of braid (i.e., 32-12-.015, T321 55), where: 32 is the number of carriers; 12 is the number of wires on each carrier; .015 is the wire diameter in inches; and T321 55 is the material, (Type 321 stainless steel).

**Braid sleeve/ring/ferrule:** a ring made from tube or metal strip placed over the ends of a braided hose to contain the braid wires for attachment of fitting and ferrule, and to immobilize heat affected corrugations.

**Braid wear:** motion between the braid and corrugated hose, which normally causes wear on the outside diameter of the corrugation and the inside diameter of the braid.

**Braided braid:** a braid where the strands of wire on each carrier of the braiding machine are braided together, and then braided in normal fashion.

**Braided ply:** a layer of braided reinforcement.

**Braid-over-braid:** multiple plies of braid having no separating layers.

**Brand:** a mark or symbol identifying or describing a product and/or manufacturer, that is embossed, inlaid or printed.

**Brass:** a family of copper/zinc alloys.

**Brazing:** a process of joining metals using a nonferrous filler metal having a melting point that is lower than the "parent metals" to be joined, typically over +800°F.

**Bronze:** an alloy of copper, tin and zinc.

**Buffing (sizing):** grinding a surface to obtain dimensional conformance or surface uniformity.

**Bumped convoluted:** a type of hose (typically fluoroplastic) made by re-forming a smooth bore tube to create annular or helical ridges or convolutions, and allow the cuffed ends to extend through the end fittings, and be flared over the fitting face, providing a seamless assembly with no metal contact. Typically used in high corrosion and sanitary applications.

**Bunch braid:** braid applied to hose in bundles rather than flat strands (plaits), usually done to achieve high pressure versus hose weight.

**Butt weld:** process in which the edges or ends of metal sections are butted together and joined by welding.

**C of C Certificate of conformance or certificate of compliance:** a document, usually signed and dated pertaining to a particular lot or purchase ( ) of item(s), which describes any standards, specifications, tests, materials and/or performance attributes to which the referenced item(s) have met or will meet.

**Cam & groove:** see Fitting/coupling -Cam & Groove.

**Capped end:** a hose end covered to protect its internal elements.

**Carcass:** the fabric, cord and/or metal reinforcing section of a hose as distinguished from the hose tube or cover.

**Casing:** see Armor.

**Cement:** unvulcanized raw or compounded rubber in a suitable solvent used as an adhesive or sealant.

**Cemented end:** a hose end sealed with the application of a liquid coating.

**Chafe sleeve:** an outer sleeve providing resistance to chafing and external resistance to damage to braided hoses, available in wide variety of materials to meet the application requirements (e.g., chafe sleeves include slip-on, heat shrinkable, integrally extruded).

**Chalking:** the formation of a powdery surface condition due to disintegration of surface binder or elastomer by weathering or other destructive environments.

**Checking:** the short, shallow cracks on the surface of a rubber product resulting from damaging action of environmental conditions.

**Chemical compatibility:** the relative degree to which a material may contact another without corrosion, degradation or adverse change of properties.

\* RAGCO supports the autonomy of its locations to select the best products to service their markets. Subtle variations of these specifications may exist. Contact your RAGCO affiliate for confirmation.



# GLOSSARY OF TERMS C

**Chemical resistance:** the ability of a particular polymer, rubber compound, or metal to exhibit minimal physical and/or chemical property changes when in contact with one or more chemicals for a specified length of time, at specified concentrations, pressure, and temperature.

**Clamp:** see Hose clamp.

**Cloth impression:** see Fabric impression.

**Coefficient of friction:** a relative measure of the surface lubricity.

**Cold flex:** see Low temperature flexibility.

**Cold flexibility:** relative ease of bending while being exposed to specified low temperature.

**Cold flow:** continued deformation under stress. See Creep.

**Collar:** 1) the portion of a fitting that is compressed by swaging or crimping to seal the hose onto the fitting barbs and create a permanent attachment; also called a ferrule. (With reusable fittings, the lock and seal are accomplished mechanically by the collar without swaging or crimping); 2) a raised portion on the hose shank which functions as a connection for a ferrule or other locking device or functions as a hose stop.

**Combustible liquid:** a combustible liquid is one having a flash point at or above +100°F (37.8°C).

**Composite hose:** non-vulcanized hose that consists of the following: An internal wire helix; A multi-ply wall of thermoplastic films and reinforcing fabrics in proportions that give the required physical properties and provide a complete seal. (Note: The film content may be built of tubular films.) A cover consisting of fabric with an abrasion resistant polymeric coating; An external helix wire.

**Compound:** the mixture of rubber or plastic and other materials, which are combined to give the desired properties when. Used in the manufacture of a product.

**Compression fitting:** see Fitting/coupling - Compression

**Compression set:** the deformation which remains in rubber after it has been subjected to and released from a specific compressive stress for a definite period of time at a prescribed temperature. (Compression set measurements are for evaluating creep and stress relaxation properties of rubber.)

**Concentricity:** the uniformity of hose wall thickness as measured in a plane normal to the axis of the hose.

**Conditioning:** the exposure of a specimen under specified conditions, e.g., temperature, humidity, for a specified period of time before testing.

**Conductive:** the ability to transfer electrical potential.

**Configuration:** the combination of fittings on a particular assembly.

**Control:** a product of known characteristics, which is included in a series of tests to provide a basis for evaluation of other products.

**Controlled flexing:** occurs when the hose is being flexed regularly, as in the case of connections to moving components (e.g., platen presses, thermal growth in pipe work).

**Convolute:** description of hose or inner core having annular or helical ridges formed to enhance flexibility.

**Convolution/corrugation:** the annular or helical flexing member in corrugated or strip wound hose/corrugation.

**Convolution count:** the number of ridges or corrugations per inch of a hose.

**Copolymer:** a blend of two polymers.

**Core:** the inner portion of a hose, usually referring to the material in contact with the medium.

**Corrosion:** the process of material degradation by chemical or electrochemical means.

**Corrosion resistance:** ability of metal components to resist oxidation.

**Corrugated cover:** a ribbed or grooved exterior.

**Corrugated hose:** hose with a carcass fluted, radially or helically, to enhance flexibility or reduce its weight.

**Coupler:** the female portion of the cam & groove connection with the cam arms.

**Coupling:** a frequently used alternative term for fitting.

**Cover wear:** the loss of material during use due to abrasion, cutting or gouging.

**Cover:** the outer component usually intended to protect the carcass of a product.

**CPE:** chlorinated polyethylene; a rubber elastomer.

**Cracking:** a sharp break or fissure in the surface, generally caused by strain and environmental conditions.

**Creep:** the deformation, in material under stress, which occurs with lapse of time after the immediate deformation.

**Crimp diameter:** the distance across opposite flats after crimping.

**Crimp/crimping:** a fitting attachment method utilizing a number of fingers or dies mounted in a radial configuration. The dies close perpendicular to the hose and fitting axis, compressing the collar, ferrule, or sleeve around the hose.

**CSM:** chlorosulfonated polyethylene.

**Cure:** the act of vulcanization. See Vulcanization.

**Cut off factor:** the hose length to be subtracted from the overall assembly length that allows for the hose coupling end connection extension beyond the end of the hose.

**Cut resistant:** having that characteristic of withstanding the cutting action of sharp object.

**Cycle-motion:** movement from normal to extreme position and return.



# GLOSSARY OF TERMS C-F

**Date Code:** any combination of numbers, letters, symbols or other methods used by a manufacturer to identify the time of manufacture of a product.

**Deburr:** to remove ragged edges from the inside diameter of a hose end; an important fabrication step for assembling hose of PTFE in order to insure a good seal.

**Deduct length:** the amount of fitting length deducted from a hose to result in the desired finished assembly length.

**Design factor:** a ratio used to establish the working pressure of the hose, based on the burst strength of the hose.

**Design pressure:** see Application working pressure and Pressure, working.

**Developed length:** see Overall length.

**Diamond weave:** braid pattern in which the strands alternately cross over one and under one of the strands (one over-one under); also known as "plain weave."

**Die:** a tool used to swage or crimp a fitting onto a hose. Swage dies usually consist of two halves machined to a predetermined diameter, designed for a specific hose type and size. A crimp die set is typically six to eight "fingers" designed for infinite diameter settings within a range or preset to a diameter for a given hose type and size.

**Dielectric strength:** the relative measure of a material's ability to resist conducting an electrical charge.

**Displacement:** the amount of motion applied to a hose defined as inches for parallel offset and degrees for angular misalignment.

**Dog-leg assembly:** two hose assemblies joined by a common elbow.

**DOT:** Department of Transportation.

**Duplex assembly:** an assembly consisting of two hose assemblies-one inside the other, and connected at the ends; also known as "jacketed assemblies."

**Durometer:** an instrument for measuring the hardness of rubber and plastic compounds.

**Durometer hardness:** a numerical value, which indicates the resistance to indentation of the blunt indenter of the durometer.

**Dye penetrant inspection/test:** nondestructive inspection method for detecting surface defects.

**Dynamic bend radius:** see bend radius, dynamic.

**Eccentric wall:** a wall of varying thickness.

**Eccentricity:** the condition resulting from the inside and outside diameters not having a common center. See eccentric wall.

**ECTFE:** ethylene-chlorotrifluoroethylene.

**Effective thrust area-hose:** cross-sectional area described by the mean diameter of the hose.

**Effusion:** the escape, usually of gases, through a material. See Permeation.

**Elastic limit:** the limiting extent to which a body may be deformed and yet return to its original shape after removal of the deforming force.

**Elastic/intermittent flexure:** The smallest radius that a given hose can be bent to without permanent deformation to the metal in its flexing members (convolutions or corrugations).

**Elastomer:** anyone of a group of polymeric materials, usually designated thermoset, such as natural rubber, or thermoplastic, which will soften with application of heat.

**Electrostatic discharge:** the sudden discharge of static electricity from an area of buildup to a grounding point.

**Elongation:** the increase in length expressed numerically as a percentage of the initial length.

**Encapsulated fitting:** see Fitting/coupling-Encapsulated fittings.

**Endurance test:** a service or laboratory test, conducted to product failure, usually under normal use conditions.

**Enlarged end:** an end having a bore diameter greater than that of the main body of the hose, in order to accommodate a larger fitting.

**EPDM:** Ethylene Propylene Diene Monomer; an elastomer.

**Exothermic:** releasing heat.

**Extrude/extruded/extrusion:** forced through the shaping die of an extruder; extrusion may have a solid or hollow cross section.

**Fabric impression:** impression formed on the rubber surface during vulcanization by contact with fabric jacket or wrapper.

**Fabricator:** the producer of hose assemblies.

**Fatigue:** the weakening or deterioration of a material occurring when a repetitious or continuous application of stress causes strain, which could lead to failure.

**FDA:** United States Food and Drug Administration.

**FEP:** fluorinated ethylene propylene.

**Ferrule:** a metal cylinder placed over a hose end to affix the fitting to the hose. See braid sleeve, interlocking ferrule, and sleeve.

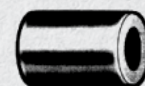

brass ferrule

**Fire sleeve:** slip-on or integrally extruded sleeve used to retard the effects of fire in certain applications; most often made with silicone and/or ceramic fiber.

**Fitting/coupling:** a device attached to the end of the hose to facilitate connection. The following is only a partial list of types of fittings available-

**Banjo Fitting** - a through bolted designed featuring a hollow circle or "donut" attached to one end of the fitting barb so that the inner diameter is along the hose axis.



barbed inserts

**Barbed inserts** - for low or medium pressure air, water and fluids. Machined brass with serrated shank; NPT or NPTF male and solid female, and



# GLOSSARY OF TERMS F

NPSM swivel female; thread seal to NPT or NPTF female, and ball end or washer seal to NPSM female. Attached with bands or clamps.

**Butt Weld Fittings** - a hose fitting designed to be permanently welded to a connecting member such as another pipe or a butt weld flange.



cam & groove

**Cam & Groove Fittings** - a type of fitting that allows connection and disconnection by means of arm(s) or cam(s) on the female fitting. The seal is accomplished by means of a gasket, available in various materials. These fittings are frequently used on product transfer hose assemblies.

**Compression Fitting** - a fitting style that seals on a mating tube by compressing an internal ferrule against the tube O.D..

**Encapsulated Fittings** - a metal fitting of various styles usually encased in a thermoplastic or fluoroplastic material by means of molding or coating. Most often done for sanitary purposes or to eliminate corrosion.

**Field Attachable Fitting** - a fitting designed to be attached to hose without crimping or swaging. This fitting is not always a Reusable type fitting.

**Flange Retainer Fittings** - a hose fitting flared to a 90° surface, designed to hold a circular rotating flange, such as a slip-on or lap joint style flange.

**Flange Style Fittings** - pipe flanges and flanged fitting standards are listed under ANSI 816.5. Flanges are rated for pressure and listed as «American Class 150, 300, 400, 600, 900, 1,500 or 2,500». Pressure- Temperature ratings can be obtained by consulting the ANSI specification or ASME 816.5 (American Society of Mechanical Engineers). Designs vary by neck and face style, or other dimensional changes based on use. Various finishes or grooves may be applied to the face for sealing on a gasket or O-ring. Bolt holes and other dimensions are per the ANSI standard.

**Slip-on Flange** - a flange designed to slip over a flange retainer and float freely in place for bolt alignment. Similar to a lap joint flange except with a very small radius on the face side of the inside diameter to mate with a machined flange retainer. May have a flat or raised face.

**Lap Joint Flange** - a flange designed to float freely on the flange retainer for bolt alignment. Made with a flat face and having a large radius on the I.D. to mate with a flared pipe style flange retainer.

**Threaded Flange** - a flange, the inside diameter of which is threaded to attach to a male pipe fitting. A leak proof seal, made with thread sealant, usually does not allow for bolt hole alignment.



interlocking

**Interlocking** - for high pressure air and water service, steam, high pressure spray, and LPG service. Plated malleable iron; insert and spud may be either steel or

malleable iron; NPT male and female with ground joint or washer seal. Attached with four bolts or two interlocking clamps.



interlocking clamps

**Interlocking Clamp** - Heavy duty high pressure applications such as air, steam, water, spray. Malleable iron, plated. Clamps are bolted into position.

**Inverted Flare Fitting** - a fitting consisting of a male or female nut, trapped on a tube by flaring the end of the tube material to either 37° or 45°.

**JIC Fittings** - joint Industrial Council (no longer in existence). An engineering group that established an industry standard fitting design incorporating a 37° mating surface, male and female styles. These standards now governed by SAE.

**Lined Fitting** - any fitting of which the wetted surface or entire fitting is covered with a protective material. The covering process may be by spray coating, molding or by inserting hose liner through the I.D. of fitting and anchoring.



long shank

**Long Shank** - designed for medium pressure air, water, sanitary and liquids in suction or discharge service. Machined brass with serrated shank; NPT or NPTF male and solid female, and

NPSM swivel female; thread seal to NPT or NPTF female, and ball end washer seal to NPSM female. Attached with clamps or bands.

**Pipe Thread Fittings** -

NPT- National Pipe Taper. Pipe thread per ANSI B1.20.1

NPTF- National Pipe Tapered for Fuels. Same as above except dry-seal per ANSI B1.20.3

NPSH- National Pipe Straight Hose per ANSI B1.20.7

NPSM- National Pipe Straight Mechanical. Straight thread per ANSI B1.20.1

NPSL- National Pipe Straight Loosefit per ANSI B1.20.1

BSPP, BSPT- British Standard Pipe Parallel, British Standard Pipe Taper. BS21.



quick acting

**Quick Acting** - for low to medium pressure; air, water or oil service where frequent and fast connections must be made. Malleable iron plated, stainless steel or bronze. Attached with interlocking clamps or bands.

**Quick Connect Fitting** - a fitting designed to quickly connect and disconnect. These fittings come in many styles and types.

**Reusable Fitting** - a fitting designed to be attached and unattached to a hose, allowing all or most of the fitting to be reused.

**Sanitary Fittings** - a fitting whose seal is accomplished by means of a round gasket in a groove on the face of the fitting. The design eliminates the need for a male and female, since the fitting mates to itself. A re-attachable clamp is also used for coupling.

**Bevel Seat** - a type of sanitary fitting incorporating a 45° beveled sealing surface. Used in the food and pharmaceutical industries.

**Combination Nipple** - for low or medium pressure suction and discharge of water, fluids, and material handling. Tubular steel, stainless, malleable



combination nipple



# GLOSSARY OF TERMS F-H

iron, aluminum or brass with serrated shank; NPT male threads, grooved, or beveled for welding. Attached with clamps or bands.



**Serrated Nipple** - for medium to high pressure air, water, and liquid service. Machined steel and plated; NPT male threads; thread or washer seal. Attached with clamps or bands

**Steel Nipple** - for medium to high pressure; wide variety of applications. Machined from cold drawn bar steel, heat treated for toughness. Attached with interlocking clamps.



steel nipple



**Short Shank**- designed for low pressure water and air service. Cast brass with serrated shank; GHT, NPSM or NPT male and HPSH female; washer seal. Attached with clamps or bands.

**Split Flange Fitting** - a fitting consisting of a flange retainer and a flange of two halves. This design allows the flanges to be installed after the retainer has been attached to the hose, making the flange reusable. SAE Code 61 and 62.



swaged or crimped

**Swaged or crimped** - for use on all types of hose where high pressures are used. Couplings consist of swaged fitting shaving serrated steel shanks with ferrules of plated steel. Attached with swaging or crimping equipment.

**Tube Fitting** - a hose fitting of which the mating end conforms to a tube diameter. The mate or male end of a compression fitting.

**2-Bolt Flange Fitting** - an elliptical flange with two bolt holes. Typically used in steam applications such as laundry and tire presses.



water suction

**Water Suction** - Heavy duty water discharge and suction service. Malleable iron and/or brass. Attached with clamps or bands.

**Flammable gases/liquid/media:** a flammable gas, including liquefied gas, is one having a closed cup flash point below +100°F (+37.8°C) and a vapor pressure greater than 25 psi. (174.2 KPa).

**Flat spots:** flat areas on the surface of cured hose caused by deformation during vulcanization.

**Flex cracking:** a surface cracking induced by repeated bending and straightening.

**Flex life:** the relative ability of an article to withstand bending stresses.

**Flex life test:** a laboratory method used to determine the life of a rubber product when subjected to dynamic bending stresses.

**Flow rate:** a volume of media being conveyed in a given time period.

**Fluid:** a gas or liquid medium.

**Fluid velocity:** the speed of fluid through a cross section expressed in length divided by time.

**Fluorocarbon:** an organic compound containing fluorine directly bonded to carbon. The ability of the carbon atom to form a large variety of structural chains gives rise to many fluorocarbons and fluorocarbon derivatives.

**Fluoron®:** a registered trademark of ICI. A term descriptive of the family of fluorocarbons and fluorocarbon derivatives in general commercial use. See PTFE.

**Fluoropolymer:** a high molecular weight (long chain) chemical containing fluorine as a major element.

**Free length:** the lineal measurement of hose between fittings or couplings.

**Frequency:** the rate of vibration or flexure in a given time period.

**Galvanic corrosion:** corrosion that occurs on the less noble of two dissimilar metals in direct contact with each other in an electrolyte, such as water, sodium chloride in solution, sulfuric acid, etc.

**GMAW:** Gas Metal Arc Weld.

**GPM:** Gallons per minute.

**GTAW:** see Tig Weld/GTAW.

**Guide (for piping):** a device that supports a pipe radially in all directions, but directs movement.

**Halar®:** Ausimont USA registered trademark. See ECTFE.

**Hand built hose:** a hose made by hand on a mandrel, reinforced by textile or wire or combination of both.

**Hardness:** resistance to indentation. See Durometer hardness.

**Heat resistance:** the property or ability to resist the deteriorating effects of elevated temperatures.

**Heat-shrink sleeving:** tubular thermoplastic sleeve used for chafe protection or identification. The sleeve is slipped over the hose and shrunk down by the application of heat to fit tightly on the hose.

**Helical wire armor/spring guard:** an abrasion resistance device.

**Helical:** used to describe a type of corrugated hose having one continuous convolution resembling a screw thread.

**Helix:** a shape formed by spiraling a wire or other reinforcement around the cylindrical body of a hose; typically used in suction hose.

**Higbee:** the thread of a hose coupling, the outermost convolution of which has been removed to such an extent that a full cross section of the thread is exposed, this exposed end being beveled.

**Hoop strength:** the relative measure of a hose's resistance to collapse of the diameter perpendicular to the hose axis.

**Hose:** a flexible conduit consisting of a tube, reinforcement, and usually an outer cover.

**Hose assembly:** see Assembly.



band clamp

device used to hold a hose onto a fitting.

\* RAGCO supports the autonomy of its locations to select the best products to service their markets. Subtle variations of these specifications may exist. Contact your RAGCO affiliate for confirmation.



# GLOSSARY OF TERMS H-L

**Band Clamp** - use with low or medium pressure and suction service. Pre-formed flat stainless steel, high carbon steel. Attached with special locking band tool.

**Double Bolt Clamp** - use with low or medium pressure and suction service with large sizes of combination nipples or couplings. Cast malleable iron, plated, and brass. Applied over hose and bolted into position.



double bolt clamp



single bolt clamp

**Single Bolt Clamp** - use with low pressure and suction service on shank couplings, combination nipples, and pipe nipples. Cast malleable iron, plated. Attached by bolting tightly on hose.

**Wire Hose Clamp** - suitable for medium pressure air, water or general purpose hose; good for hose with helical wire or corrugations; available in larger sizes for pin lug, serrated pipe nipple or combination. Pre-formed round wire made of stainless steel, galvanized steel, copper, bronze or aluminum. Wire ends pulled and crimped with special tool or machine.



wire hose clamp

**Hostafon®**: a registered trademark of Dyneon. See PFA.

**Hydrostatic testing**: the use of liquid pressure to test a hose or hose assembly for leakage, twisting, and/or hose change-in-length.

**Hypalon®**: a DuPont registered trademark. See CSM.

**Hytrel®**: a DuPont registered trademark.

**I.D.**: the abbreviation for inside diameter.

**Identification yarn**: a yarn of single or multiple colors, usually embedded in the hose wall, used to identify the manufacturer.

**Impression**: a design formed during vulcanization in the surface of a hose by a method of transfer, such as fabric impression or molded impression.

**Impulse service**: an application parameter characterized by continuous cyclical pressure changes from low to high.

**Impulse**: an application of force in a manner to produce sudden strain or motion, such as hydraulic pressure applied in a hose.

**Indentation**: 1) the extent of deformation by the indenter point of anyone of a number of standard hardness testing instruments; 2) a recess in the surface of a hose.

**Innecore**: the innermost layer of a hose; the hose material in contact with the medium.

**Insert**: optional term for nipple. See Nipple.

**Interlocked hose**: formed from profiled strip and wound into flexible metal tubing with no subsequent welding, brazing, or soldering; may be made pressure-tight by winding in strands of packing.

**Interlocking clamp**: a clamp which engages the fitting in a manner which prevents the clamp from sliding off the fitting, typically a bolt or U-bolt style with interlocking fingers which engage an interlock ring on the fitting.

**Interlocking ferrule**: a ferrule, which physically attaches to the fitting preventing the ferrule from sliding off the fitting.

**Interstice**: a small opening, such as between fibers in a cord or threads in a woven or braided fabric.

**IPT**: iron pipe threads; a reference to NPT or NPTF.

**ISO**: International Organization for Standardization.

**Jacket**: seamless tubular braided or woven ply generally on the outside of hose.

**JIC**: see Fitting/coupling-JIC.

**Kinking**: temporary or permanent distortion of the hose induced by bending beyond the minimum bend radius.

**Kynar®**: ELF Atochem registered trademark. See PVDF.

**Lap seam**: seam made by placing the edge of one piece of material extended flat over the edge of the second piece of material.

**Lap weld (LW)**: type of weld in which the ends or edges of the metal overlap each other.

**Lay**: 1) the direction of advance of any point in a strand for one complete turn; (2) the amount of advance of any point in a strand for one complete turn. See Pitch.

**Layer**: a single thickness of rubber or fabric between adjacent parts.

**Leaker**: 1) a crack or hole in the tube which allows fluids to escape; 2) a hose assembly which allows fluids to escape at the fittings or couplings.

**Life test**: a laboratory procedure used to determine the resistance of a hose to a specific set of destructive forces or conditions. See Accelerated life test.

**Light resistance**: the ability to retard the deleterious action of light.

**Lined bolt holes**: the bolt holes, which have been given a protective coating to cover the internal structure.

**Liner**: flexible sleeve used to line the inside diameter of hose when conveying a high velocity media, also prevents erosion.

**Live length**: see Free length.

**LJF (lap joint flange)**: see Fitting/coupling -Lap Joint Flange.

**Long shank**: a shank length greater than the nominal diameter, typically two diameters in length, which allows more than a single clamp.

**Loop installation**: the assembly is installed in a loop or "U" shape, and is most often used when frequent and/or large amounts of motion are involved.

**Low temperature flexibility**: the ability of a hose to be flexed, bent or bowed at low temperatures without loss of serviceability.

**LPG, LP Gas**: the abbreviation for liquefied petroleum gas.

**MAWP**: see pressure, maximum allowable working.

**Mandrel**: 1) a form, generally of elongated round section used for size and to support hose during fabrications and/



# GLOSSARY OF TERMS L-P

or vulcanization. It may be rigid or flexible; 2) a tapered expanding device, fixed in diameter, which is pulled through a shank of a fitting thus expanding the diameter to exert force on the hose between the shank and ferrule.

**Mandrel built:** a hose fabricated and/or vulcanized on a mandrel.

**Mandrel, flexible:** a long, round, smooth rod capable of being coiled in a small diameter. It is used for support during the manufacture of certain types of hose. (The mandrel is made of rubber or plastic material and may have a core of flexible wire to prevent stretching.)

**Mandrel, rigid:** a non-flexible cylindrical form on which a hose may be manufactured.

**Manufacturer's identification:** a code symbol used on or in some hose to indicate the manufacturer.

**Mass flow rate:** the mass of fluid per unit of time passing through a given cross-section of a flow passage in a given direction.

**Mean diameter:** the midpoint between the inside diameter and the outside diameter of a corrugated/convoluted hose.

**Mechanical fitting/reusable fitting:** a fitting attached to a hose, which can be disassembled and used again.

**Media, medium:** the substance(s) being conveyed through a system.

**Mender:** a fitting or device used to join two sections of hose.

**Metal hose:** thin wall metal tubing formed into flexible hose with helical or annular ridges and grooves, often braided with stainless steel to increase the operating pressure capability. With fittings welded on, assemblies are used in applications outside temperature range of rubber, thermoplastic and fluoroplastic.

**Misalignment:** a condition where two parts do not meet true.

**NAHAD:** the abbreviation for the National Association of Hose & Accessories Distributors.

**Necking down:** a localized decrease in the cross-sectional area of a hose resulting from tension.

**Neoflon®:** a registered trademark of Daikin USA.

**Neoprene®:** a registered trademark of DuPont.

**Nipple:** the internal member or portion of a hose fitting.

**Nitrile rubber (NB/Buna-N):** a family of acrylonitrile elastomers used extensively for industrial hose.

**Nominal:** a size indicator for reference only.

**Nomograph:** a chart used to compare hose size to flow rate to recommended velocity.

**Non-conductive:** the inability to transfer an electrical charge.

**Non-interlocking ferrule:** see Sleeve.

**Nozzle end:** an end of hose in which both the inside and outside diameters are reduced.

**NPT/NPTF:** abbreviation for national pipe threads. See fitting/coupling -Pipe Thread Fittings.

**Nylon:** a family of polyamide materials.

**OAL:** overall length

**O.D.:** the abbreviation for outside diameter.

**OE/OEM:** original equipment manufacturer.

**Off-center:** see Eccentricity.

**Offset-lateral, parallel:** the distance that the ends of a hose assembly are displaced in relation to each other as the result of connecting two misaligned terminations in a system, or intermittent flexure required in a hose application.

**Oil resistance:** the ability of the materials to withstand exposure to oil.

**Oil swell:** the change in volume of a rubber article resulting from contact with oil.

**Open steam cure:** a method of vulcanizing in which steam comes in direct contact with the product being cured.

**Operating conditions:** the pressure, temperature, motion, and environment to which a hose assembly is subjected.

**O-ring fitting:** a fitting that seals by means of an elastomeric ring of a specified material.

**OS& D hose:** the abbreviation for oil suction and discharge hose.

**Overall length (OAL):** the total length of a hose assembly, which consists of the free hose length plus the length of the coupling(s).

**Oxidation:** the reaction of oxygen on a material, usually evidenced by a change in the appearance or feel of the surface or by a change in physical properties.

**Ozone cracking:** the surface cracks, checks or crazing caused by exposure to an atmosphere containing ozone.

**Ozone resistance:** the ability to withstand the deteriorating effects of ozone (generally cracking).

**PFA:** perfluoroalkoxy

**Penetration (weld):** the percentage of wall thickness of the two parts to be joined that is fused into the weld pool in making a joint.

**Performance test (service test):** a test in which the product is used under actual service conditions.

**Permanent fitting:** the type of fitting which, once installed, may not be removed for reuse.

**Permeation:** the process of migration of a substance into and through another, usually the movement of a gas into and through a hose material; the rate of permeation is specific to the substance, temperature, pressure and the material being permeated.

**Pharmacopoeia Class VI:** a standard for sanitary fittings, designating the form, fit, function and finish.

**Pick:** the distance across a group of braid wires from a single carrier, measured along the axis of the hose.

**Pig:** a mechanical projectile used for cleaning hose.

**Pin pricked:** perforations through the cover of a hose to vent permeating gases.

\* RAGCO supports the autonomy of its locations to select the best products to service their markets. Subtle variations of these specifications may exist. Contact your RAGCO affiliate for confirmation.



# GLOSSARY OF TERMS P-S

**Pitch:** 1) the distance from one point on a helix to the corresponding point on the next turn of the helix, measured parallel to the axis; 2) the distance between the two peaks of adjacent corrugation or convolution.

**Pitted tube:** surface depressions on the inner tube of a hose.

**Plain ends:** fitting ends without threads, groove, or a bevel typically used for welding, as in a flange.

**Plaits:** an individual group of reinforcing braid wires/strands.

**Plating:** a material, usually metal, applied to another metal by electroplating, for the purpose of reducing corrosion; typically a more noble metal such as zinc is applied to steel.

**Ply:** an individual layer in hose construction.

**Pneumatic testing:** the use of compressed air to test a hose or hose assembly for leakage, twisting, and/or hose change-in-length. NOTE: Use of high pressure air is extremely hazardous.

**Polyflon®:** a registered trademark of Daikin USA. See PTFE.

**Polymer:** a macromolecular material formed by the chemical combination of monomers, having either the same or different chemical compositions.

**Post-sinter:** the technique of re-heating PTFE inner core to process temperature in order to reduce permeability.

**Preform:** the compressed cylinder of PTFE resin that is used to extrude into raw tubing. Also called a billet.

**Pre-production inspection or test:** the examination of samples from a trial run of hose to determine adherence to a given specification, for approval to pro( )

**Preset:** the process of pressurizing a hose to set the braid and minimize length change in final product.

**Pressure:** force + unit area. For purposes of this document, refers to PSIG (pounds per square inch gauge).

**Pressure drop:** the measure of pressure reduction or loss over a specific length of hose.

**Pressure, burst:** the pressure at which rupture occurs.

**Pressure, deformation:** the pressure at which the convolutions of a metal hose become permanently deformed.

**Pressure, gauge:** relative pressure between inside and outside of an assembly.

**Pressure, maximum allowable working:** the maximum pressure at which a hose or hose assembly is designed to be used.

**Pressure, operating:** see Pressure, working.

**Pressure, proof test:** a nondestructive pressure test applied to hose assemblies.

**Pressure, pulsating:** a rapid change in pressure above and below the normal base pressure, usually associated with reciprocating type pumps.

**Pressure, rated working:** see Pressure, maximum allowable working.

**Pressure, service:** see Working pressure.

**Pressure, shock/spike:** the peak value of a sudden increase of pressure in a hydraulic or pneumatic system producing a shock wave.

**Pressure, working:** the maximum pressure to which a hose will be subjected, including the momentary surges in pressure, which can occur during service. Abbreviated as WP.

**Printed brand:** see Brand.

**Profile:** used in reference to the contour rolled into strip during the process of manufacturing strip wound hose, or the finished shape of a corrugation on/convolution,

**Propane:** see LPG, LP Gas.

**PSI:** pounds per square inch.

**PTFE:** polytetrafluoroethylene, a high molecular weight fluoroplastic polymer with carbon atoms shielded by fluorine atoms having very strong inter atomic bonds, giving it chemical inertness.

**Pull off force:** the force required to pull the hose from its attachment not generated by the internal pressure.

**PVC:** polyvinyl chloride. A low cost thermoplastic material typically used in the manufacture of industrial hoses. The operating temperature range is -500°F to +1750°F (-295.5°C to +954.4°C)

**PVDF:** polyvinylidene fluoride.

**Quality conformance inspection or test:** the examination of samples from a production run of hose to determine adherence to given specifications, for acceptance of that production.

**RAC:** Rubber Association of Canada.

**Random motion:** the uncontrolled motion of a metal hose, such as occurs in manual handling.

**Reinforcement:** the strengthening members, consisting of either fabric, cord, and/or metal, of a hose. See Ply.

**Reusable fitting/coupling:** see Fitting/coupling, reusable.

**RMA:** The Rubber Manufacturers Association, Inc.

**SAE:** Society of Automotive Engineers.

**Safety factor:** see Design factor.

**Sampling:** a process of selecting a portion of a quantity for testing or inspection, selected without regard to quality.

**Santoprene®:** a registered trademark of Monsanto.

**Scale:** the oxide in a hose assembly brought about by surface conditions or welding.

**Serrations:** bumps, barbs, corrugations, or other features that increase the holding power of the device.

**Service temperature:** see Working temperature



# GLOSSARY OF TERMS S-U

**Shank:** that portion of a fitting, which is inserted into the bore of a hose.

**Shelf/storage life:** the period of time prior to use during which a product retains its intended performance capability

**Shell:** see Ferrule.

**Shock load:** a stress created by a sudden force.

**Short shank:** shank length, approximately equal to the nominal diameter, but long enough to allow a single clamp at minimum.

**Simulated service test:** see Bench test.

**Skive:** the removal of a short length of cover and/or tube to permit the attachment of a fitting directly over the hose reinforcement.

**Sleeve:** a metal cylinder, which is not physically attached to the fitting, for the purpose of forcing the hose into the serrations of the fitting.

**Smooth bore:** a term used to describe the type of inner core in a hose.

**Socket:** the external member or portion of a hose fitting I commonly used in describing screw-together reusable fittings.

**Soft end:** a hose end in which the rigid reinforcement of the body, usually wire, is omitted.

**Specification:** a document setting forth pertinent details of a product.

**Spiral:** a method of applying reinforcement in which there is not interlacing between individual strands of the reinforcement.

**Spiral angle:** the angle developed by the intersection of the helical strand and a line parallel to the axis of a hose. See braid angle.

**Splice:** a fitting or device used to join two sections of hose.

**Spring guard:** a helically wound component applied internally or externally to a hose assembly, used for strain relief, abrasion resistance, collapse resistance.

**Squirm:** a form of failure where the hose is deformed into an "S" or "U" bend, as the result of excessive internal pressure being applied to unbraided corrugated hose while its ends are restrained or in a braided corrugated hose which has been axially compressed.

**Standard:** a document, or an object for physical comparison, for defining product characteristics, products, or processes, prepared by a consensus of a properly constituted group of those substantially affected and having the qualifications to prepare the standard for use.

**Static bonding:** use of a grounded conductive material between fittings to eliminate static electrical charges.

**Static conductive:** having the capability of furnishing a path for a flow of static electricity.

**Static discharge:** see Electrostatic discharge.

**Static wire:** wire incorporated in a hose to conduct static electricity.

**Stem:** see Nipple.

**Stress corrosion:** a form of corrosion in metal.

**Strip wound:** see Interlocked hose.

**Surge (spike):** a rapid and transient rise in pressure.

**Swage:** the method of fitting attachment that incorporates a set of die halves designed to progressively reduce the collar or ferrule diameter to the required finish dimension by mechanically forcing the fitting into the mating die.

**Swelling:** an increase in volume or linear dimension of a specimen immersed in liquid or exposed to a vapor.

**Tape wrapped convoluted:** a type of flexible hose incorporating layers of tape to form helical ridges and grooves.

**Tear resistance:** the property of a rubber tube or cover of a hose to resist tearing forces.

**Teflon®:** a registered trademark of E.I. DuPont. See PTFE, FEP and PFA.

**TFE:** Polytetrafluoroethylene. See PTFE.

**Tig weld/GTAW:** the gas tungsten arc welding process sometimes referred to a "shielded arc" or "heliarc."

**Traveling loop, Class A Loop:** an application wherein the radius remains constant and one end of the hose moves parallel to the other end.

**Traveling loop, Class B Loop:** a condition wherein a hose is installed in a U-shaped configuration and the ends move perpendicular to each other so as to enlarge or decrease the width of the loop.

**Tube:** the innermost continuous all-rubber or plastic element of a hose

**Tube fitting:** see Fitting/coupling- Tube.

**Tubing:** a non-reinforced, homogeneous conduit, generally of circular cross-section.

**Twist:** (1) the turns about the axis, per unit of length, of a fiber, roving yarn, cord, etc. Twist is usually expressed as turns per inch; (2) the turn about the axis of a hose subjected to internal pressure.

**Unsintered:** material that has not undergone primary heat processing.

**Vacuum formed convoluted:** smooth bore hose that is made flexible by the formation of ridges and grooves during a process that utilizes heat and vacuum to mechanically form convolutions.

**Vacuum resistance:** the measure of a hoses ability to resist negative gauge pressure.

**Velocity resonance:** vibration due to the buffeting of a high velocity gas or liquid flow.

**Vibration:** amplitude motion occurring at a given frequency

**Viscosity:** the resistance of a material to flow.

**Volume change:** a change in dimensions of a specimen due to exposure to a liquid or vapor.

**Volume swell:** see Swelling.



# GLOSSARY OF TERMS V-W

**Volumetric expansion:** the volume increase of hose when subjected to internal pressure.

**Vulcanization:** a process during which a rubber compound, through a change in its chemical structure, improves or extends elastic properties over a greater range of temperature.

**Weathering:** the surface deterioration of a hose cover during outdoor exposure as shown by checking, cracking, crazing and chalking

**Wire reinforced:** a hose containing wires to give added strength, increased dimensional stability; crush resistance. See Reinforcement.

**Working temperature:** the temperature range of the application, may include the temperature of the fluid conveyed or the environmental conditions the assembly is exposed to in use.

**WP:** the abbreviation for working pressure.

**Wrapped cure:** a vulcanizing process using a tensioned wrapper (usually of fabric) to apply external pressure

The preceding Glossary of Terms, as utilized in the hose industry, includes some definitions from The Hose Handbook, published by the Rubber Manufacturers Association.

**verall length (OAL):** the total length of a hose assembly, which consists of the free hose length plus the length of the coupling(s).



# BASIC HOSE CONSTRUCTION

## COVER

The cover is the outermost or visible area of the hose. It is designed to be a protective covering against wear, abrasion, cuts, weather, and the general destructive action encountered in normal service.

## BODY OR CARCASS

The body reinforcement is the supporting structure of the hose. It can range from simple to complex combinations and consists of cord, yarn, fabric, wire, or any combination of these.

## TUBE OR LINING

The tube is the innermost element of a hose and is compounded to provide resistance to the material being carried. With the wide range of rubber compounds available, a hose can be built to withstand abrasive materials, chemicals, oil and a wide variety of other materials.

## THE FOUR BASIC METHODS OF HOSE CONSTRUCTION

Keep in mind that a reference to any one of these types of construction will imply all the characteristics and benefits outlined here plus specific features attained through the proper compounding of rubber, choice materials, and variation in plies and thickness to ensure that each hose is exactly right for the job for which it is designed.

### TYPE 1: VERTICAL BRAIDED HOSE

Entire hose length cured in one operation.

- A. Extruded seamless tube
- B. Seamless reinforcing braids of synthetic textile wire—or other material—applied by high-speed vertical or horizontal braiders
- C. Rubber layers between braids establish positive bond between braids when vulcanized
- D. Extruded, seamless cover

**Advantages:** Flexible. High resistance to kinking. Cover either smooth or wrapped. Available in long, continuous lengths. Excellent tensile strength.



## TYPE 2: SPIRAL HOSE

Built by machine with either textile or wire cord reinforcement applied so that each ply is laid at a given angle for maximum dimensional stability.

- A. Extruded or calendared tube
- B. Reinforcement of synthetic textile wire or other material
- C. Rubber layers between reinforcement plies to establish positive bond
- D. Cover

**Advantages:** Extremely flexible. Smooth bore, uniform tube. High strength with long-length capability.

## TYPE 3: HAND-BUILT SPIRALED PLY HOSE

Built by hand on a mandrel. Cured under pressure applied from outside by cloth wraps and steam.

- A. Calendared, or "built-up" tube to fit service
- B. Tailor-made spiral wrapped fabric
- C. Wire reinforcement where needed
- D. Cover stock of selected gauge and compound; wrap cured

**Advantages:** Craftsman-built to special requirements. Wide variation in sizes, constructions, and materials. Built-in strength to fit most rugged job requirements. Couplings, fittings, nipples, flanges and beaded ends can be built in. Available in lengths up to 50 feet, in sizes up to 18 inches. On larger diameters, consult your Ragco location.

## TYPE 4: KNITTED HOSE

- A. Extruded seamless tube
- B. Seamless woven textile jacket
- C. Interwoven wire helix reinforcement where needed
- D. Extruded seamless cover



# CARE, MAINTENANCE, AND STORAGE

A hose has a limited life and the user must be alert to signs of impending failure, particularly when the conditions of service include high working pressures and/or the conveyance or containment of hazardous materials. The periodic inspection and testing procedures described here provide a schedule of specific measures, which constitute a minimum level of user action to detect signs indicating hose deterioration or loss of performance before conditions leading to malfunction or failure are reached.

**WARNING:** Failure to properly follow the manufacturer's recommended procedures for the care, maintenance and storage of a particular hose might result in its failure to perform in the manner intended and might result in possible damage to property and serious bodily injury.

General instructions are also described for the proper storage of a hose to minimize deterioration from exposure to elements or environments that are known to be deleterious to rubber products. Proper storage conditions can enhance and extend substantially the ultimate life of hose products.

## GENERAL CARE AND MAINTENANCE OF YOUR HOSE

A hose should not be subjected to any form of abuse in service. It should be handled with reasonable care. Hose should not be dragged over sharp or abrasive surfaces unless specifically designed for such service.

Care should be taken to protect the hose from severe end loads for which the hose or hose assembly were not designed. The hose should be used at or below its rated working pressure; any changes in pressure should be made gradually so as to not subject the hose to excessive surge pressures.

A hose should not be kinked or be run over by equipment. In handling large-size hose, dollies should be used whenever possible; slings or handling rigs, properly placed, should be used to support heavy hoses used in oil suction and discharge service.

## GENERAL TEST AND INSPECTION PROCEDURES FOR YOUR HOSE

An inspection and hydrostatic test should be made at periodic intervals to determine if a hose is suitable for continued service. A visual inspection of the hose should be made for loose covers, kinks, soft spots that might indicate broken or displaced reinforcement.

The couplings or fittings should be closely examined and, if there is any sign of movement of the hose from the couplings, the hose should be removed from service. The periodic inspection should include a hydrostatic test for one minute at 150% of the recommended working pressure of the hose. An exception to this would be the woven-jacketed fire hose.\*

During the hydrostatic test, the hose should be straight, not coiled or in a kinked position. Water is the usual test medium and, following the test, the hose may be flushed with alcohol to remove traces of moisture. A regular schedule for testing should be followed and inspection records maintained.

\* A woven-jacket fire hose should be tested in accordance with the service test provisions contained in the current edition of National Fire Protection Association Bulletin No. 1962 - Standard for the Care, Use and Service Testing of Fire Hose.



# CARE, MAINTENANCE, AND STORAGE

## STORAGE

Rubber hose products in storage can be affected adversely by temperature, humidity, ozone, sunlight, oils, solvents, corrosive liquids and fumes, insects, rodents and radioactive materials.

The appropriate method for storing a hose depends to a great extent on its size (diameter and length), the quantity to be stored, and the way in which it is packaged. A hose should not be piled or stacked to such an extent that the weight of the stack creates distortions on the lengths stored at the bottom.

Since hose products vary considerably in size, weight, and length, it is not practical to establish definite recommendations on this point. A hose having a very light wall will not support as much load as a hose having a heavier wall or a hose having a wire reinforcement. A hose that is shipped in coils or bales should be stored so that the coils are in a horizontal plane.

Whenever feasible, rubber hose products should be stored in their original shipping containers, especially when such containers are wooden crates or cardboard cartons that provide some protection against the deteriorating effects of oils, solvents, and corrosive liquids; shipping containers also afford some protection against ozone and sunlight.

Certain rodents and insects will damage rubber hose products, and adequate protection from them should be provided.

A cotton-jacketed hose should be protected against fungal growths if the hose is to be stored for prolonged periods in humidity conditions in excess of 70%.

The ideal temperature for the storage of rubber products ranges from 50°To 70° F (10°C to 21°C) with a maximum limit of 100°F (38°C). If stored below 32°F (0°C), some rubber products become stiff and would require warming before being placed in service. Rubber products should not be stored near sources of heat, such as radiators, base heaters, etc.

To avoid the adverse effects of high-ozone concentration, rubber hose products should not be stored near electrical equipment that may generate ozone or be stored for any lengthy period in geographical areas of known high-ozone concentration. Exposure to direct or reflected sunlight, even through windows, should also be avoided. An uncovered hose should not be stored under fluorescent or mercury lamps that generate light waves harmful to rubber.

Storage areas should be relatively cool and dark, and free of dampness and mildew. Items should be stored on a first-in, first-out basis, since even under the best of conditions, an unusually long shelf life could deteriorate certain rubber products.

(From RMA Hose Handbook IP-2 Sixth Edition 1996)



# CARE, MAINTENANCE, AND STORAGE

## SAFETY WARNING

Before conducting any pressure tests on a hose, provisions must be made to ensure the safety of the personnel performing the tests and to prevent any possible damage to property. Only trained personnel using proper tools and procedures should conduct any pressure tests.

1. Air or any other compressible gas must never be used as the test media because of the explosive action of the hose should a failure occur. Such a failure might result in possible damage to property and serious bodily injury.
2. Air should be removed from the hose by bleeding it through an outlet valve while the hose is being filled with the test medium.
3. The hose to be pressure tested must be restrained by placing steel rods or straps close to each end and at approximate 10 foot (3m) intervals along its length to keep the hose from "whipping" if failure occurs; the steel rods or straps are to be anchored firmly to the test structure, but in such a manner that they do not contact the hose which must be free to move.
4. The outlet end of hose is to be bulwarked so that a blown-out fitting will be stopped.
5. Provisions must be made to protect testing personnel from the forces of the pressure media if a failure occurs.
6. Testing personnel must never stand in front of or in back of the ends of a hose being pressure tested.
7. When liquids such as gasoline, oil, solvent, or other hazardous fluids are used as the test fluid, precautions must be taken to protect against fire or other damage should a hose fail and the test liquid be sprayed over the surrounding area. A hose has a limited life and the user must be alert to signs of impending failure, particularly when the conditions of service include high working pressures and/or the conveyance or containment of hazardous materials. The periodic inspection and testing procedures described here provide a schedule of specific measures that constitute a minimum level of user action to detect signs indicating hose deterioration or loss of performance before conditions leading to malfunction or failure are reached.

**WARNING:** Failure to properly follow the manufacturer's recommended procedures for the care, maintenance and storage of a particular hose might result in its failure to perform in the manner intended, and might result in possible damage to property and serious bodily injury.



# S.T.A.M.P.E.D.

Use this simple acronym to determine the right product for you. Knowledge of your required parameters will help to endure proper function while a hose is in service.

<b>SIZE</b>	Refers to the overall dimensions of the hose required for your particular needs. You'll need to know the hose ID, OD and length. If the assembled length is critical to the hose's application, you may need to determine overall assembled lengths (length including fittings).
<b>TEMPERATURE</b>	Refers to the temperature of the application, which is an important factor, particularly how hot it is. Consider both internal (media and friction) and external (ozone and sunlight) temperatures. Most rubber compounds will naturally begin to break down as it approaches 200° Fahrenheit. There are specially-blended rubber compounds that are made to withstand higher temperatures, such as EPDM and Viton.
<b>APPLICATION</b>	Refers to the environment in which the hose is being used. Is there a direct exposure to sunlight? If so, your customer will need a hose that is made from a compound that has ozone resistance, such as EPDM. Is there direct exposure to oil or petroleum products? If so, your customer will need a hose that is made from a compound that has oil or aromatic resistance, such as NITRILE.
<b>MEDIA</b>	Refers to what product is running through the system. This parameter is important because the media will come in contact with the ID of the hose. Certain rubber compounds are made to withstand particular media. For example, NITRILE is good for oil/petroleum-based products, and GUM is good for abrasives.
<b>PRESSURE</b>	Refers to how much pressure is going through the system. Be aware of any spikes in pressure and allow for these drastic changes in the design and selection of your hose. It is equally important to be aware of the correlation between temperature and pressure. A hose cannot be used at its maximum-rated working pressure and maximum-rated temperature at the same time.
<b>ENDS</b>	Refers to which fittings are needed and how they are to be attached to the hose. A hose assembly is rated for the lesser of the working pressure of the hose and the fittings. So, a 4-inch 200 psi hose with aluminum cam-and-groove fittings double banded on will only be rated for 100 psi.
<b>DELIVERY</b>	Refers to when the assembly is expected on a job.

\* RAGCO supports the autonomy of its locations to select the best products to service their markets. Subtle variations of these specifications may exist. Contact your RAGCO affiliate for confirmation.



# BEND RADIUS

**Bend Radius:** The minimum bend radius of a hose is an important factor in hose selection if it will be subject to sharp curvatures in normal use. The bend radius (calculated in a lab environment; applications may vary) is measured as the distance to the inside edge of the hose (not the center line) when making a 90° bend. When bent at too sharp an angle, the reinforcement may be unduly stressed or distorted, thereby shortening the hose life. Textile-reinforced hoses have a tendency to kink as the bend radius is reduced. Generally, a “helix” is used when a hose must withstand severe bends without flattening or kinking.

**SPECIAL NOTE:** Perhaps more important in determining flexibility in an application, the “force-to-bend” is defined as the amount of stress required to induce bending around a specified bend radius. Some hoses with thick walls, large bores, short lengths, or heavy-duty construction will NOT bend easily without significant physical exertion.

## GENERAL FORMULA TO DETERMINE BEND LENGTH

$$\frac{\text{Angle of Bend}}{360^\circ} \times 2\pi r = \text{minimum length of hose to make bend}$$

$r = \text{given bend radius of hose}$

Example: To make a 90° bend with a hose with a 2" I.D. Given  $r = 4.5$  inches

$$\frac{90^\circ}{360^\circ} [2 \times 3.14 \times 4.5] \quad .25 \times 2 \times 3.14 \times 4.5 = 7"$$

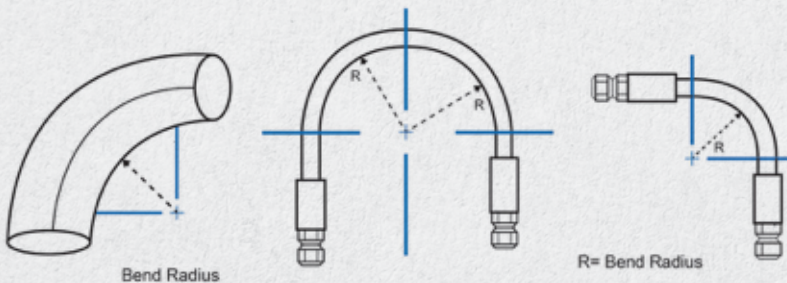



# TEMPERATURE DE-RATING CHART

The effect of elevated temperature on any hose system is significant and often overlooked. Since the lay line of most hoses indicates the maximum WP and the maximum temperature, it can be assumed the hose assembly will achieve both at the same time. Hot hoses get soft and are more pliable, hampering the ability of the attachment to hold the couplings securely on the hose. Since Campbell's pressure ratings are established by testing at 70°F, we established a separate pressure de-rating chart for elevated temperatures.

ELEVATED TEMPERATURE DE-RATING CHART – DE-RATING FACTOR APPLIES TO HOSE SYSTEM PRESSURE RATINGS										
HOSE TYPE	70°	90°	150°	200°	250°	300°	350°	400°	450°	500°
STEAM	1.00	0.95	0.81	0.68	0.56	0.44	0.32	0.20	0.08	N/R
HOT TAR & ASPHALT	1.00	0.95	0.81	0.68	0.56	0.44	0.32	0.20	0.08	N/R
PVC	1.00	0.82	0.30	N/R	N/R	N/R	N/R	N/R	N/R	N/R
RUBBER	1.00	0.91	0.64	0.42	0.20	N/R	N/R	N/R	N/R	N/R
CHEMICAL	1.00	0.91	0.64	0.42	0.20	N/R	N/R	N/R	N/R	N/R
AIR	1.00	0.91	0.64	0.42	0.20	N/R	N/R	N/R	N/R	N/R
SOFT	1.00	0.91	0.64	0.42	0.20	N/R	N/R	N/R	N/R	N/R

## HOW THE DE-RATING CHART WORKS:

The chart lists temperatures across the top and hose type down the left column. Based on your hose system application, locate the appropriate de-rating factor and multiply it by the hose system pressure rating in the pressure chart above.

### STEAM HOSE EXAMPLE:

1. Hose – ¾" steam hose, rated to 250 psi at 406°F
2. Coupling/Attachment – Campbell Viton Seal Ground Joint Couplings with crimp ferule are rated to 1250 psi at 70°F
3. Operating temperature – 406°F
4. De-rating factor at 406° – .20
5. Hose System de-rating –  $1250 \times .20 = 250$  psi \*

### RUBBER HOSE EXAMPLE:

1. Hose – 3" air hose rated to 500 psi
2. Coupling/Attachment – Long Shank Crimpology Nipple with Long Ferrule rated to 600 psi
3. Operating Temperature – 150°F
4. De-rating factor – .64
5. Hose System de-rating –  $600 \text{ psi} \times .64 = 384 \text{ psi}^*$

\* After the de-rating is calculated for the fitting and attachment, check maximum working pressure of the hose.

The hose system should never operate at a higher pressure than the lowest-rated component. (Example: 150 psi-rated hose with 500 psi-rated coupling and attachment at 90°F. The de-rating factor is .90. So, the newly calculated pressure rating is  $500 \times .90 = 450$  psi. Since the hose is rated to 150 psi, then the maximum working pressure of the system is still 150 psi.

On a typical summer day at any construction site, compressors crank out high-pressure air to operate tools and equipment. Between the weather and the compressor motors, the compressed air gets dangerously hot. So hot, that those hoses can no longer safely operate at the intended pressure rating. Our de-rating chart shows that at 150°F, the hose system should operate at 64% of the pressure rating given for 70°F. That's when 500 psi should be 320 psi. Know the safety limits of hoses.



# OIL AND GASOLINE RESISTANCE

A rubber hose is used to convey petroleum products both in the crude and refined stages. The aromatic content of refined gasoline is often adjusted to control the octane rating. The presence of aromatic hydrocarbons in this fuel generally has a greater effect on rubber components than do aliphatic hydrocarbons.

Aromatic materials in contact with rubber tend to soften it and reduce its physical properties. For long-lasting service, the buyer of a gasoline hose should inform the hose manufacturer of the aromatic content of the fuel to be handled so that the proper tube compound can be recommended for the specific application.

The effects of oil on rubber depend on a number of factors that include the type of rubber compound, the composition of the oil, the temperature, and time of exposure. Rubber compounds can be classified as to their degree of oil resistance based on their physical properties after exposure to a standard test fluid.

In this RMA classification, the rubber samples are immersed in IRM 903 oil at 100°C for 70 hours. (See ASTM Method 0-471 for a detailed description of the oil and the testing procedure.) As a guide to the user of a hose in contact with oil, the oil-resistance classes and a corresponding description are listed.

PHYSICAL PROPERTIES AFTER EXPOSURE TO OIL		
	VOLUME CHANGE MAXIMUM	TENSILE STRENGTH RETAINED
Class A (High oil resistance)	+25%	80%
Class B (Medium/High oil resistance)	+65%	50%
Class C (Medium oil resistance)	+100%	40%

(From RMA Hose Handbook IP-2 Sixth Edition)



# CHEMICAL COMPATIBILITY RUBBER

	N	S	N	I	C	E	X	U
	R	R	R	R	M	M	P	H
								M
								W
								P
								E
Absorption Oil	X	X	G	E	X	G	X	G
Acetal	C	C	C	X	G	C	C	G
Acetaldehyde	C	X	F	X	E	C	G	E
Acetamide	C	C	G	G	E	G	E	E
Acetate Solvents	C	X	X	X	C	X	C	E
Acetic Acid 10%	X	X	G	X	G	G	G	E
Acetic Acid 30%	X	X	C	G	G	G	G	E
Acetic Acid 50%	X	X	C	C	G	X	G	E
Acetic Acid, Glacial	X	X	C	X	G	X	X	G
Acetic Aldehyde	X	N	N	N	G	X	E	E
Acetic Anhydride	X	X	G	X	E	G	E	E
Acetic Ester (Ethyl Acetate)	X	X	X	X	G	X	G	E
Acetic Ether (Ethyl Acetate)	X	X	X	X	G	C	G	E
Acetic Oxide (Acetic Anhydride)	X	X	X	X	C	G	G	E
Acetone	C	C	F	X	E	F	E	E
Acetone Cyanohydrin	X	X	N	N	G	N	G	E
Acetophenone	C	X	X	X	E	X	E	G
Acetyl Acetone	X	X	X	X	G	X	E	E
Acetyl Chloride	X	X	X	X	C	X	C	G
Acetyl Oxide	X	N	N	X	E	G	E	E
Acetyl-P-Toluidine	X	X	N	N	X	N	X	E
Acetylene	E	E	G	E	E	E	E	E
Acetylene Dichloride (Dichloroethylene)	X	X	N	N	X	N	X	X
Acetylene Tetrachloride	X	X	N	N	X	N	X	X
Acrolein (hydroquinone inhibited)	N	N	N	N	G	N	X	E
Acrylamide	N	N	N	X	N	N	X	E
Acrylates (HEA or HPA)	N	N	N	N	N	N	X	E
Acrylic Acid	N	N	N	N	N	N	N	G
Acrylonitrile	G	X	X	X	X	X	X	G
Adipic Acid	N	G	G	G	E	E	G	N
Aeroshell 7A. 17 Grease	N	N	G	E	N	N	N	N
Air	E	E	E	E	E	E	E	E
Air, 300° F	X	X	X	X	N	X	X	N
Aircraft Hydraulic Oil AA	N	N	N	E	X	N	X	E
Alachlor (Lasso)	E	N	N	N	N	N	N	E
Alcohols, Aliphatic	E	G	E	E	E	E	E	E
Alcohols, Aromatic	C	X	C	C	X	X	X	E
Alkaline Liquid (NOS)	N	N	N	N	E	E	N	E
Alk-Tri (Trichloroethylene)	X	N	N	X	X	X	N	E
Alkaryl Polyether Alcohol	N	N	N	N	N	N	N	E
Alkaryl Sulfonate Alkylbenzene Sulfonate	E	N	N	E	N	X	N	E
Allyl Alcohol	E	G	E	E	E	E	E	E
Allyl Bromide	X	X	X	X	X	X	X	G
Allyl Chloride	X	X	X	X	X	X	X	G
Alpha Methylstyrene	X	X	X	X	X	N	X	G
Alpha Olefin Sulfonate	E	N	N	N	N	N	N	N
Alum (Ammonium Potassium Sulfate)	E	E	E	E	E	E	E	E
Aluminum	E	E	E	E	E	E	E	E
Aluminum Acetate	E	E	N	N	N	N	N	N
Aluminum Alkyl	X	X	X	X	X	X	X	X
Aluminum Bromide	E	E	E	E	E	E	E	N
Aluminum Chloride	E	E	E	E	E	E	E	E
Aluminum Chlorohydrate Solution (to 50%)	N	N	N	E	E	N	E	E
Aluminum Flouride	E	E	E	E	E	E	E	E
Aluminum Formate	X	N	N	X	G	X	N	E
Aluminum Hydroxide	E	E	E	E	E	G	E	E
Aluminum Nitrate	E	E	E	E	E	E	E	E

	N	S	N	I	C	E	X	U
	R	R	R	R	M	M	P	H
								M
								W
								P
								E
Aluminum Phosphate	E	E	E	E	E	E	E	E
Aluminum Salts	E	E	E	E	E	E	E	N
Aluminum Sulfate	G	E	E	E	E	E	E	E
Aminobenzene	N	N	N	N	N	N	N	N
Aminodimethylbenzene	N	N	N	N	N	N	N	N
Aminoethanol	G	N	N	G	E	G	N	E
Aminoethylethanolamine	N	N	N	N	E	N	G	G
Ammonia, Anhydrous	E	C	E	G	E	G	E	E
Ammonia Cupric Sulfate	X	N	N	E	E	E	E	E
Ammonia, Liquid	G	G	E	E	E	E	E	E
Ammonia, in Water	G	G	G	G	G	G	E	E
Ammonium Acetate	E	E	G	E	E	E	E	E
Ammonium Bicarbonate	E	N	N	N	N	N	N	N
Ammonium Bisulfate (50%)	N	N	N	N	G	N	G	G
Ammonium Carbonate	E	E	E	C	E	E	E	E
Ammonium Chloride	E	E	E	E	E	E	E	E
Ammonium Flouride	E	N	N	N	N	N	N	N
Ammonium Hydroxide	G	G	E	G	E	G	E	E
Ammonium Metaphosphate	E	E	E	E	E	E	E	E
Ammonium Nitrate	G	E	E	E	E	E	E	E
Ammonium Nitrite	E	E	E	E	E	E	E	E
Ammonium Persulfate	E	X	E	X	E	E	G	E
Ammonium Phosphate	E	E	E	E	E	E	E	E
Ammonium Sulfate	E	E	E	E	E	E	E	E
Ammonium Sulfide	E	E	E	E	E	E	E	E
Ammonium Sulfite	E	E	E	E	E	E	E	E
Ammonium Thiocyanate	E	E	E	E	E	E	E	E
Ammonium Thiosulfate	E	E	E	E	E	E	E	E
Amyl Acetate	C	X	X	X	G	X	G	X
Amyl Acetone	X	X	X	X	G	X	G	E
Amyl Alcohol	E	E	E	E	E	E	E	E
Amylamine	C	G	X	C	G	C	X	E
Amylbenzene	X	X	G	G	X	N	X	G
Amyl Borate	X	X	C	E	E	C	X	E
Amyl Chloride	X	X	X	X	X	X	X	E
Amyl Chloronaphthalene	X	X	X	G	X	X	X	E
Amyl Naphthalene	X	X	X	X	X	X	X	E
Amyl Oleate	X	X	X	X	G	X	G	E
Amyl Phenol	X	X	X	X	X	X	X	E
Amyl Phthalate	X	N	N	X	E	X	N	E
Anethole	X	X	X	X	X	X	X	G
Anhydrous Ammonia	X	X	X	X	X	X	X	X
Aniline	X	X	X	X	E	X	C	E
Aniline Dyes	C	C	C	C	G	C	G	E
Aniline Hydrochloride	E	C	X	C	C	X	G	E
Animal Fats	X	X	G	E	G	F	C	E
Animal Gelatin	N	N	E	E	N	N	N	E
Animal Grease	X	X	G	G	C	C	G	E
Animal Oils	X	X	X	E	G	X	C	E
Ansul Ether	X	X	X	C	C	X	C	E
Antifreeze (Ethylene Glycol)	E	E	E	E	E	E	E	E
Antimony Trichloride	X	X	G	G	E	G	G	E
Ant Oil (Furfural)	X	X	G	X	X	G	X	E
Antimony Pentachloride	X	X	X	X	C	X	C	G
Antimony Salts	N	N	N	G	E	N	E	N
Aqua Ammonia	G	G	G	G	G	E	E	E
Aqua Regia	X	X	X	X	X	C	C	X

\* RAGCO supports the autonomy of its locations to select the best products to service their markets. Subtle variations of these specifications may exist. Contact your RAGCO affiliate for confirmation.





# CHEMICAL COMPATIBILITY RUBBER

	N	S	B	C	N	I	C	E	X	U
	R	R	R	R	R	R	M	M	E	H
										M
										W
										P
										E
Argon	X	X	X	C	G	X	E	N	N	
Arguad	E	E	E	E	E	E	E	E	E	
Aromatic Hydrocarbons	X	X	X	C	X	X	X	E	E	
Aromatic Tar	X	N	N	X	X	X	X	E	E	
Arsenic Acid	E	E	E	E	E	E	E	E	E	
Arsenic Chloride	X	X	E	C	X	X	G	X	X	
Arsenic Trichloride	X	X	E	C	X	X	G	X	X	
Asphalt	X	X	G	E	X	X	G	G	G	
ASTM Fuel A	X	X	E	E	X	G	X	N	N	
ASTM Fuel B	X	X	X	E	X	X	X	N	N	
ASTM Fuel C	X	X	X	G	X	X	X	N	N	
ASTM Oil No. 1	X	X	E	E	X	G	X	E	E	
ASTM Oil No. 2	X	X	G	E	X	F	X	E	E	
ASTM Oil No. 3	X	X	G	E	X	F	X	E	E	
ASTM Oil No. 4	X	X	X	G	X	X	X	N	N	
Automatic Trans. Fluid	X	X	G	E	X	C	X	N	N	
Aviation Gasoline	X	X	C	E	X	X	X	E	E	
Baltic Types 100, 150, 200, 300, 500	N	N	N	E	X	N	X	E	N	
Bardol B	X	X	X	X	X	X	X	E	N	
Barium Carbonate	E	E	E	E	E	E	E	E	E	
Barium Chloride	E	E	E	E	E	E	E	E	E	
Barium Hydroxide	E	E	E	E	E	E	E	E	E	
Barium Sulfate	E	E	E	E	E	E	E	E	E	
Barium Sulfide	E	E	E	E	E	E	E	E	E	
BBP (Butyl Benzyl Phthalate)	X	N	N	X	E	X	N	N	N	
Beer	E	E	G	C	E	E	G	N	N	
Beet Sugar Liquors	E	E	E	E	E	E	E	E	E	
Bellows 80-20 Hydraulic Oil	N	N	N	E	X	N	X	E	N	
Benzaldehyde	X	N	N	X	G	X	G	E	E	
Benzal Chloride	N	N	N	X	G	N	N	E	E	
Benzene (Benzol)	X	X	X	X	X	X	X	E	G	
Benzene Sulfonic Acid	X	X	X	N	G	G	N	E	E	
Benzidine	E	X	X	G	X	N	X	G	N	
Benzine	X	X	G	E	X	X	X	E	E	
Benzene Solvent (Ligroin)	X	N	N	E	X	X	X	E	E	
Benzoic Acid	G	X	E	X	E	G	G	E	E	
Benzoic Aldehyde	X	X	X	X	X	X	X	E	E	
Benzophenone	E	N	N	N	N	N	N	E	N	
Benzotrichloride	X	X	X	X	X	X	X	G	G	
Benzoyl Chloride	X	X	X	X	X	X	X	G	G	
Benzyl Acetate	X	X	X	X	G	G	G	E	E	
Benzyl Alcohol	G	G	C	X	G	F	G	E	E	
Benzyl Benzoate	N	N	N	N	G	N	G	E	N	
Benzyl Chloride	X	X	X	X	C	X	X	E	E	
Bichromate of Soda (Sodium Dichromate)	X	X	G	X	E	G	C	E	E	
Bismuth Carbonate	E	N	X	N	N	N	N	N	N	
Bisphenol A	E	N	N	N	N	N	N	N	N	
Bitumastic	X	X	G	G	X	X	X	N	X	
Black Sulfate Liquor	G	G	E	G	E	G	E	E	E	
Blast Furnace Gas	X	X	G	C	C	G	C	E	E	
Bleach	X	X	C	X	X	F	G	E	E	
Borax Solution	G	G	E	C	E	E	E	E	E	
Bordeaux Mixture	G	G	E	E	E	E	E	E	E	
Boric Acid	E	E	E	E	E	E	E	E	E	
Brake Fluid (HD-557)	N	E	G	C	G	G	E	N	N	
Brine	E	E	E	E	E	E	E	E	E	

	N	S	B	C	N	I	C	E	X	U
	R	R	R	R	R	R	M	M	E	H
										M
										W
										P
										E
Bromine	X	X	X	X	X	C	X	X	X	
Bromine Water	X	X	G	C	C	E	C	E	E	
Bromobenzene	X	X	X	X	X	X	X	C	C	
Bromochloroethane	X	X	N	N	X	X	X	X	X	
Bromochloromethane	X	X	X	X	X	X	X	X	X	
Bromotoluene	X	X	N	N	X	N	X	N	N	
Bubble Bath Compounds	N	N	N	N	N	N	N	N	E	
Bunker Oil	X	X	G	E	X	X	X	E	E	
Butadiene	X	X	F	X	X	C	X	F	F	
Butandiol (Butylene Glycol)	N	N	N	N	N	N	N	E	G	
Butane	X	X	E	E	E	G	X	E	N	
Butanoic Acid	N	N	N	N	N	N	N	N	N	
Butanol	E	E	E	E	E	E	E	E	E	
Butraldehyde (Butanal)	X	X	X	X	X	X	X	G	N	
Butter (Non FDA)	C	C	G	E	E	E	G	E	E	
Butyl Acetate	X	X	X	X	G	X	C	G	G	
Butyl Acetoacetate	X	N	N	X	X	X	N	E	E	
Butyl Acrylate	X	X	X	X	X	X	X	G	G	
Butyl Alcohol	E	E	E	E	E	E	E	E	E	
Butyl Aldehyde	X	N	N	X	X	X	X	E	E	
Butylamine	G	C	X	C	C	C	C	E	E	
Butyl Benzene	X	X	X	X	X	X	X	E	E	
Butyl Benzyl Phthalate (BBP)	X	N	N	X	E	X	N	N	N	
Butyl Bromide	X	X	X	X	X	X	X	G	G	
Butyl Butyrate	X	X	X	X	C	X	G	G	G	
Butyl Carbitol	X	X	G	G	E	E	E	E	E	
Butyl Cellosolve	X	X	G	G	E	G	E	E	E	
Butyl Chloride	X	X	X	X	C	X	C	G	G	
Butylate	N	N	N	N	N	N	E	N	E	
Butylene	X	X	G	G	C	G	C	E	E	
Butyl Ether	X	X	G	G	C	G	C	E	E	
Butyl Ethyl Acetaldehyde	X	X	X	X	C	X	X	E	E	
Butyl Ethyl Ether	X	X	X	X	C	G	C	E	E	
Butyl Formate	X	N	X	X	N	N	N	N	N	
Butyl Mercaptan (2-Methyl - 2 Butanathiol)	X	X	N	X	X	N	X	E	N	
Butyl Oleate	X	X	X	X	G	X	G	E	E	
Butyl "Oxiol"™ tm for EG Monobutyl Ether	N	N	N	N	N	N	E	E	N	
Butyl Phthalate	X	X	X	X	C	X	C	E	E	
Butyl Stearate	X	X	X	G	C	X	C	E	E	
Butylene Glycol	N	N	N	N	N	N	N	E	G	
Butyraldehyde	X	N	N	X	G	X	X	E	E	
Butyric Acid	G	G	X	N	G	X	G	E	E	
Butyric Anhydride	C	X	X	C	C	G	C	E	E	
Cadmium Acetate	X	N	N	X	G	N	N	N	N	
Calcine Liquor (Radioactive Waste)	N	N	N	E	E	N	E	E	N	
Calcium Acetate	C	X	X	X	E	X	E	E	E	
Calcium Aluminate	E	N	E	E	E	E	N	N	N	
Calcium Aresenate	N	N	N	N	N	N	N	E	N	
Calcium Bisulfate	E	E	E	E	E	E	E	E	E	
Calcium Bisulfide	G	G	E	E	E	E	N	E	N	
Calcium Bisufite	C	E	E	E	G	E	C	E	E	
Calcium Bromide Solution	N	N	N	N	N	N	N	E	E	
Calcium Bichromate	N	N	N	N	E	F	N	G	F	
Calcium Carbonate	E	E	E	E	E	E	E	E	E	
Calcium Chlorate	G	G	E	E	G	E	G	E	N	
Calcium Chloride	E	E	E	E	E	E	E	E	E	
Calcium Hydroxide	E	G	E	E	E	G	E	E	E	

\* RAGCO supports the autonomy of its locations to select the best products to service their markets. Subtle variations of these specifications may exist. Contact your RAGCO affiliate for confirmation.





# CHEMICAL COMPATIBILITY RUBBER

	U H M W							
	N	S	N	I	C	E	X	
	R	R	R	R	M	M	E	P
Calcium Hydrosulfide	G	G	E	E	E	N	E	N
Calcium Hypochlorite	X	X	X	X	G	F	G	G
Calcium Metasilicate	E	G	N	G	G	G	N	N
Calcium Nitrate	E	E	E	E	E	E	E	E
Calcium Silicate	E	G	N	G	G	G	N	N
Calcium Stearate	E	N	N	N	N	N	N	N
Calcium Sulfate	E	E	E	E	E	E	E	E
Calcium Sulphhydrate	E	E	E	E	E	E	E	E
Calcium Sulfide	E	E	E	E	E	E	E	E
Calcium Sulfite	E	E	E	E	E	E	E	E
Caliche Liquor (Crude Sodium Nitrate)	E	E	G	C	E	E	E	E
Camphene (Liquid above 115° F)	N	N	N	N	N	X	X	N
Cane Sugar Liquors (Non F.D.A.)	E	E	E	E	E	E	E	E
Caproic Acid	N	N	N	N	N	N	G	E
Caprolactam	E	N	N	N	N	N	N	N
Caprylic Acid	X	N	N	X	G	G	N	E
Carbamates	X	X	X	X	X	X	X	N
Carbitol	X	X	G	G	E	G	G	E
Carbitol Acetate	X	X	X	X	G	X	G	E
Carbolic Acid (Phenol)	X	X	C	X	G	C	C	E
Carbon Bisulfide (See Carbon Disulfide)	N	N	N	N	N	N	N	N
Carbon Dioxide	E	E	E	E	E	E	E	E
Carbon Disulfide	X	X	X	X	X	X	X	C
Carbonic Acid	E	E	E	E	E	E	E	E
Carbon Monoxide	E	E	E	E	E	E	E	E
Carbon Tetrachloride	X	X	X	C	G	X	G	C
Carbon Tetrafluoride	X	X	X	C	X	X	X	C
Carbonyl Chloride	X	X	X	X	E	X	X	X
Casein	N	N	N	N	E	N	N	N
Castor Oil	C	X	G	E	G	C	G	E
Caustic Potash (Potassium Hydroxide)	E	G	G	E	E	E	E	E
Caustic Soda (Sodium Hydroxide)	E	G	G	G	E	G	E	E
Cellose	X	N	N	X	E	E	E	E
Cellsolve	X	X	E	G	G	G	G	E
Cellulose Acetate	C	X	C	X	G	C	G	G
Cellulube	C	X	X	X	G	X	E	E
Cement, Portland	N	N	N	N	E	N	N	E
China Wood Oil (Tung Oil)	X	X	G	E	G	G	G	E
Chlordane	N	N	X	X	N	X	X	E
Chlorinated Napthalene	X	X	X	X	X	X	N	N
Chlorinated Solvents	X	X	N	N	X	X	X	X
Chlorine Dioxide	X	X	X	X	X	C	X	G
Chlorine Gas (Dry)	C	C	X	C	C	G	C	G
Chlorine Trifluoride	N	N	N	N	N	N	X	N
Chlorine, Water Solutions (2%)	C	X	X	X	C	G	C	E
Chloroacetic Acid	G	X	X	X	C	X	C	E
Chloroacetone	X	X	X	X	G	G	X	E
Chlorobenzene	X	X	X	X	X	X	X	G
Chlorobenzol	X	N	N	X	X	X	X	E
Chlorobromomethane	X	X	X	X	X	X	X	G
Chlorobutane	X	X	X	X	X	X	X	G
Chlorobutadiene	X	X	X	X	X	X	X	G
Chloroethylbenzene	X	X	X	X	X	X	X	E

	U H M W							
	N	S	N	I	C	E	X	
	R	R	R	R	M	M	E	P
Chloroform	X	X	X	X	X	X	X	G
Chloronapthalene	X	X	X	X	X	X	X	N
Chlorinated Hydrocarbons	X	X	X	X	X	X	X	G
Chloropentane	X	X	C	X	X	X	X	E
Chlorophenol	X	X	X	X	X	X	X	G
Chloropropanone	X	X	X	X	C	X	C	G
Chlorosulfonic Acid	X	X	X	X	X	C	X	G
Chlorothene (Trichloroethane)	X	X	X	X	X	X	X	G
Chlorotoluene	X	X	X	X	X	X	X	G
Chlorox	G	G	G	N	G	G	N	G
Chlorpyrifos	N	N	N	N	N	N	X	N
Chrome Alum	E	E	E	E	E	E	E	N
Chrome Plating Solutions	X	X	X	X	X	X	G	N
Chromic Acid	X	X	X	X	X	E	C	E
Citgo FR Fuels	N	N	X	E	E	N	N	E
Citric Acid	E	E	G	G	E	E	E	E
Coal Oil	X	X	G	E	X	X	X	E
Coal Tar	X	X	G	E	X	G	G	E
Coal Tar Naptha	X	X	F	E	X	X	X	E
Coal Tar Pitch	X	X	G	G	X	G	X	N
Cobalt Chloride	E	E	E	E	E	E	E	E
Coconut Oil	X	X	G	E	G	G	C	E
Cod Liver Oil	X	X	G	E	E	G	E	E
Coke Oven Gas	X	X	X	X	F	X	X	E
Copper Arsenate	E	E	E	E	E	E	E	E
Copper Chloride	E	E	E	E	E	E	E	E
Copper Cyanide	E	E	E	E	E	E	E	E
Copper Hydrate	X	N	N	G	E	G	N	E
Copper Hydroxide	F	G	N	N	E	G	N	E
Copper Nitrate	E	E	E	E	E	E	E	E
Copper Nitrite	E	E	E	E	E	E	E	E
Copper Sulphate	F	E	E	E	E	E	E	E
Copper Sulphide	C	E	E	E	E	E	E	E
Corn Oil	X	X	C	E	E	G	C	E
Corn Syrup	G	G	G	G	G	G	G	E
Cottonseed Oil	X	X	C	C	C	G	C	C
Creosols	X	N	N	X	E	X	X	E
Creosote	X	N	N	X	X	X	X	E
Creosote (Wood)	X	X	C	G	X	C	X	E
Creosote (Coal Tar)	X	X	C	G	X	C	X	E
Creosols	X	X	C	C	X	C	X	E
Cresylic Acid	X	X	C	C	X	C	X	E
Crotonaldehyde	X	X	X	X	E	X	C	E
Crotonic Acid	X	X	N	G	E	N	G	E
Crude Oil	X	X	F	E	X	X	X	E
Crude Wax	N	N	N	G	G	N	N	G
Cyrolite	X	X	G	E	X	X	X	N
Cumene	X	X	X	C	C	X	X	E
Cupric Arsenate	G	G	N	N	N	G	N	E
Cupric Carbonate	C	C	G	G	E	G	E	E
Cupric Chloride	C	C	G	E	E	E	E	E
Cupric Cyanide	G	G	G	G	G	G	G	E
Cupric Hydroxide	N	N	N	N	N	N	N	N
Cupric Nitrate	C	C	G	E	E	E	E	E
Cupric Nitrite	C	C	G	E	E	E	E	E
Cupric Sulfate	F	E	G	E	E	E	E	E

\* RAGCO supports the autonomy of its locations to select the best products to service their markets. Subtle variations of these specifications may exist. Contact your RAGCO affiliate for confirmation.





# CHEMICAL COMPATIBILITY RUBBER

	N	S	B	C	N	I	C	P	L	E	X	U
	R	R	R	R	R	R	M	M	E	M	W	H
	R	R	R	R	R	M	M	E	E	P	P	M
Cutting Oil	X	X	G	E	X	X	X	G	N			
Cutting Oil (Sulfur Base)	N	N	X	E	N	N	N	N	N			
Cutting Oil (Water Solutions)	N	N	X	E	N	N	N	N	N			
Cyanide, Copper	G	G	G	G	G	G	G	E	N			
Cyanide Mercuric	G	G	E	G	G	E	G	E	N			
Cyanide, Silver	N	N	E	N	N	N	N	E	N			
Cyanide, Sodium	E	E	E	E	E	E	E	E	N			
Cyclohexane	X	X	X	G	X	X	X	E	E			
Cyclohexanol	X	X	G	C	X	X	X	E	E			
Cyclohexanone	X	X	X	X	X	X	X	E	E			
Cyclohexylamine	N	X	N	N	E	N	E	N	N			
Cyclopentane	X	X	G	G	X	X	X	E	E			
Cyclopentanol	X	X	N	N	X	X	N	E	E			
Cyclopentanone	X	N	N	X	X	X	N	N	N			
P-Cymene	X	X	X	C	X	X	X	E	E			
DDT in Kerosene	X	X	G	E	F	X	X	E	E			
Decaline	X	X	X	X	X	X	X	E	E			
Decanal	X	N	N	X	X	X	N	N	N			
Decanol	X	N	X	E	X	G	N	N	N			
Decane	X	X	X	G	X	X	X	E	E			
Decyl Alcohol	X	N	N	E	E	E	E	E	E			
Decyl Aldehyde	X	N	N	X	X	X	N	N	N			
Decyl Butyl Phthalate	X	N	N	X	E	X	N	E	E			
Deicing Fluid	N	N	E	E	E	G	E	E	E			
Denatured Alcohol	E	E	E	E	E	E	E	E	E			
Detergent, Water Solutions	G	G	G	E	G	G	E	E	E			
Developing Fluid (pictures)	E	G	E	E	E	E	G	N	N			
Dextrin	N	N	E	E	X	N	X	X	N			
Dextron	N	N	N	E	X	N	X	X	N			
DHSO Butylene	X	X	X	G	X	X	X	E	N			
Diacetone Alcohol	X	X	G	X	E	G	G	E	E			
Diammonium Phosphate	N	N	N	N	N	N	N	N	N			
Diamylamine	G	C	E	G	E	C	C	E	E			
Diamyl Naphthalene	X	X	N	N	X	X	N	E	N			
Diamyl Phenol	X	N	N	X	X	X	X	E	E			
Diamylene	X	N	N	X	X	X	N	E	E			
Diazonin	E	E	N	N	N	N	E	N	N			
Dibenzyl Ether	X	X	X	X	G	X	X	E	E			
Dibenzyl Sebacate	C	X	X	X	G	X	G	E	E			
Dibromobenzene	X	X	X	X	X	X	X	G	G			
Dibromomethane	X	X	X	X	X	X	X	G	G			
Dibutyl Ether	X	X	X	X	X	X	C	E	E			
Dibutylamine	G	F	G	E	F	F	G	E	E			
Dybutylphthalate	X	X	X	X	G	X	E	E	E			
Dibutyl Sebacate	X	X	X	X	G	X	G	G	G			
Dicalcium Phosphate	E	E	E	E	E	E	E	E	E			
Dicamba	N	N	N	N	N	N	E	E	E			
Dichloroacetic Acid	X	N	N	X	X	X	X	E	E			
Dichloroaniline	N	X	X	X	X	N	X	N	N			
Dichlorobenzene	X	X	X	X	X	X	X	G	G			
Dichlorobenzyl	X	X	X	X	X	X	X	G	N			
Dichlorobutane	X	X	X	X	X	X	X	E	E			
Dichlorodifluorometh	X	X	E	G	X	X	X	E	E			
Dichloroethane	X	X	X	X	C	X	X	E	C			
Dichloroethyl Ether	X	X	X	X	X	X	X	E	E			
Dichloroethylene	X	X	X	X	C	X	X	E	X			
Dichlorohexane	X	X	X	X	X	X	X	E	E			

	N	S	B	C	N	I	C	P	L	E	X	U
	R	R	R	R	R	R	M	M	E	M	W	H
	R	R	R	R	R	M	M	E	E	P	P	M
Dichloroisopropyl Ether	X	X	X	X	X	X	X	E	E			
Dichloromethane	X	X	X	X	X	X	X	E	E			
Dichloropentane	X	X	X	X	X	X	X	E	E			
Dichloropropane	X	X	N	N	X	X	N	E	E			
Dichlorotoluene	N	N	N	N	N	N	N	N	N			
Dicyclohexylamine	N	N	N	N	N	N	N	N	N			
DIDA (Diisodecyl Adipate)	X	N	N	X	E	X	N	N	N			
Dieldrin Xylene	X	X	X	X	X	X	X	E	E			
Dieidrin in Xylene (And Water Spray)	X	X	G	G	X	X	X	E	E			
Diesel Fuel	X	X	G	E	X	X	X	E	E			
Diesel Oil	X	X	G	E	X	C	X	E	E			
Diethanol Amine	G	G	G	G	E	F	F	E	E			
Diethyl Benzene	X	X	X	X	X	X	X	E	E			
Diethyl Carbonyl	E	N	N	E	E	E	N	E	E			
Diethyl Ether	X	X	C	G	X	X	X	E	E			
Diethyl Ketone	F	X	N	N	G	X	N	E	E			
Diethylphthalate	X	X	X	X	E	X	G	E	E			
Diethyl Oxalate	C	X	X	X	C	X	E	E	E			
Diethyl Sebacate	X	X	X	X	E	X	C	E	E			
Diethyl Sulfate	X	X	X	X	G	X	G	E	E			
Diethyl Sulfide	N	N	N	N	N	N	N	E	N			
Diethyl Triamine	G	C	G	G	E	C	G	E	E			
Diethylacetaldehyde	N	N	N	N	N	N	N	E	N			
Diethylamine	N	N	N	N	N	N	N	N	G			
Diethylene Dioxide	X	X	X	X	G	X	G	E	N			
Diethylene Glycol	E	E	E	E	E	E	E	E	E			
Diethylene Glycol Methyl Ether	N	N	N	N	N	N	N	E	N			
Diethylene Glycol Monobutyl Ether	N	N	N	N	N	N	N	E	N			
Diethylene Glycol Monobutyl Ether Acetate	N	N	N	N	N	N	N	E	N			
Diethylenetriamine	G	G	C	G	E	C	E	E	E			
Dihydroxyacetone	N	N	N	N	N	N	E	E	N			
Dihydroxydiethyl Ether	E	E	E	E	E	N	E	E	E			
Dihydroxyethyl Amine	G	C	G	G	E	C	G	E	E			
Dihydroxyethyl Ether	E	E	G	E	E	E	G	E	E			
Diisobutylene	X	X	G	E	X	X	X	E	E			
Diisobutyl Ketone	X	X	X	X	G	X	G	E	E			
Diisobutyl Phenol	E	N	N	N	N	N	N	N	N			
Diisocyanate	X	X	X	X	X	X	X	X	X			
Diisooctyl Phthalate	X	N	N	X	E	X	E	N	N			
Diisooctyl Adipate	X	N	N	X	E	X	N	E	E			
Diisodecyl Adipate	X	X	E	X	X	C	E	E	E			
Diisodecyl Phthalate	X	X	X	X	E	C	E	E	E			
Diisooctyl Adipate	X	X	X	X	E	X	E	E	E			
Diisooctyl Phthalate	X	X	X	X	E	C	E	E	E			
Diisopropanolamine	G	N	N	G	E	N	N	N	N			
Diisopropyl Benzene	X	X	X	C	X	X	X	E	E			
Diisopropyl Ether	X	X	X	G	X	X	X	E	E			
Diisopropyl Ketone	X	X	X	X	E	X	E	E	E			
Diisopropylidene Acetone	X	X	X	X	G	X	G	E	N			
Dilauryl Ether	X	X	X	C	X	C	X	E	E			
Dimethyl Aniline	X	X	X	X	G	X	X	E	N			
Dimethyl Benzene	X	N	N	X	X	X	X	E	E			
Dimethyl Carbonyl	E	N	N	E	E	E	E	E	E			
Dimethyl Ether	X	X	X	X	G	X	E	E	E			
Dimethyl Formamide	N	N	N	N	N	N	N	G	E			
Dimethyl Ketone	G	F	F	X	E	F	E	E	E			

\* RAGCO supports the autonomy of its locations to select the best products to service their markets. Subtle variations of these specifications may exist. Contact your RAGCO affiliate for confirmation.





# CHEMICAL COMPATIBILITY RUBBER

	S		N		I		C		P		L		W	
	N	B	C	B	I	S	D	P	D	P	P	P	P	P
	R	R	R	R	R	M	M	E	E	E	E	E	E	E
Dimethyl Phenol	X	N	N	X	X	X	X	E	E					
Dimethyl Phthalate	X	X	X	X	E	X	G	E	E					
Dimethyl Sulfate	X	X	X	X	G	X	X	E	E					
Dimethyl Sulfide	X	X	X	X	C	X	X	G	G					
Dimethyl Terephthalate	N	X	X	X	X	N	N	N	N					
Dimethylamine	G	F	G	G	E	F	E	E	E					
Dimethylaminoethanol	N	N	N	N	N	N	G	E	N					
Dimethylaniline	X	X	X	X	X	X	C	G	G					
Dimethylbenzene	X	X	X	X	X	X	X	E	E					
Dimethylcarbinol	G	G	G	E	E	G	E	E	E					
Dimethylformamide (DMF)	C	C	C	X	C	C	C	E	E					
DMP (Dimethylaminoethyl Phenol)	N	N	N	N	N	N	N	E	N					
Dinitrobenzene	X	X	C	X	C	X	C	E	E					
Dinitrotoluene	X	X	X	X	X	X	X	E	E					
Diocetyl Adipate (DOA)	X	X	X	X	E	X	G	E	E					
Diocetylamine	G	G	X	G	E	C	G	E	E					
Diocetyl Phosphite	N	N	N	N	N	N	X	E	N					
Diocetyl Phthalate (DOP)	X	X	X	X	G	X	G	E	E					
Diocetyl Sebacate (DOS)	X	X	X	X	G	X	G	E	E					
Dioxane	X	X	X	X	G	X	G	E	E					
Dioxolane	X	X	X	X	C	X	G	E	E					
Dipentene	X	X	N	X	N	N	X	G	N					
Dipentene (Limonene)	X	X	X	X	C	X	X	E	E					
Diphenyl (Biphenyl)	X	X	X	X	X	X	X	E	E					
Diphenyl Oxide (Phenyl Ether)	X	X	X	X	X	C	X	E	E					
Diphenyl Phthalate	X	N	N	X	E	X	N	E	E					
Dipropylene Glycol	E	N	N	E	E	N	N	E	E					
Dipropyl Ketone	X	X	X	X	G	X	G	E	E					
Dipropylamine	G	G	G	G	E	C	E	E	E					
Dirco Oils	N	N	N	E	X	N	X	E	N					
Disodium Phosphate	E	E	E	E	E	E	E	E	E					
Distillate Fuel Oil	N	N	N	N	N	N	X	G	N					
Divinyl Benzene	X	X	X	X	X	X	X	E	E					
Dodecyl Benzene	X	X	X	X	X	X	X	E	E					
Dodecylphenol	N	N	N	N	N	N	E	E	N					
Dodecyl Toluene	X	X	X	X	X	X	X	E	E					
Dolomite	N	N	E	N	N	E	G	N	N					
Dowfume W 40, 100%	X	X	C	X	X	C	C	G	G					
Dow-Per (perchloroethylene)	X	X	X	C	X	X	X	E	E					
Dowtherm Oil, A and E	X	X	X	X	X	C	X	E	E					
Dowtherm S. R. I.	E	E	E	E	E	E	E	E	E					
Dry Cleaning Fluids	X	X	X	C	X	X	X	E	G					
Duro Oils	N	N	N	E	X	N	X	E	N					
EDTA (Ethylenediaminetetraacetic Acid)	N	N	N	N	N	N	E	E	N					
Emulsion (Oil in Water)	N	N	N	N	N	N	E	E	E					
Enamels	N	N	N	N	N	N	X	E	N					
Epichlorohydrin	X	X	X	X	C	C	G	G	G					
Epoxy Resin	N	N	E	N	G	N	E	N	N					
Essential Oils	X	X	G	E	N	N	X	G	N					
Ethanoic Acid	N	N	N	N	N	N	N	N	N					
Ethanol (Grain Alcohol)	X	X	X	X	X	X	X	N	G					
Ethanolamine	G	G	G	G	E	C	E	C	E					
Ethers	X	X	X	X	F	F	C	E	E					
Ethyl Acetate	X	X	X	X	G	X	C	E	E					
Ethyl Acetoacetate	X	X	X	X	G	X	G	E	E					
Ethyl Acrylate	X	X	X	X	C	X	X	G	G					
Ethyl Alcohol	X	X	X	X	X	X	X	N	G					

	S		N		I		C		P		L		W	
	N	B	C	B	I	S	D	P	D	P	P	P	P	P
	R	R	R	R	R	M	M	E	E	E	E	E	E	E
Ethyl Aldehyde	F	N	N	N	E	E	N	E	E					
Ethyl Aluminum Dichloride 90°F	X	N	N	X	X	X	N	N	N					
Ethyl Benzene	X	X	X	F	X	X	X	G	G					
Ethyl Benzoate	X	X	C	G	G	C	G	E	E					
Ethyl Bromide	X	X	X	X	X	X	X	G	N					
Ethyl Butanol	E	E	E	E	E	E	E	E	E					
Ethyl Butyrate	X	X	X	X	G	N	N	E	N					
Ethyl Butyl Acetate	X	N	N	X	E	G	N	E	E					
Ethyl Butyl Alcohol	E	E	E	E	E	E	E	E	E					
Ethyl Butyl Amine	G	C	G	G	E	C	G	E	E					
Ethyl Butyl Ketone	X	X	X	X	G	X	G	E	E					
Ethyl Butyraldehyde	X	N	N	X	G	X	N	E	E					
Ethyl Cellulose	G	G	G	G	G	G	G	E	E					
Ethyl Chloride	F	F	F	F	X	X	X	E	G					
Ethyl Chloroformate	N	N	N	X	N	N	X	G	G					
Ethyl Dichloride	X	X	X	X	X	X	X	G	G					
Ethylene	X	X	G	E	X	C	X	E	E					
Ethyl Ether	X	X	X	C	C	X	X	E	E					
Ethyl Ether Acetate	N	N	N	X	N	N	G	E	N					
Ethyl Formate	X	N	N	X	G	X	G	E	E					
Ethyl Hexoic Acid	X	N	N	X	X	G	N	E	E					
Ethyl Hexyl Acetate	X	N	N	X	E	G	N	E	E					
Ethyl Iodine	X	N	X	X	X	X	X	N	N					
Ethyl Isobutyl Ether	X	N	N	G	X	G	X	E	E					
Ethyl Isobutyrate	X	N	X	X	X	N	X	E	N					
Ethyl Mercaptan	X	X	X	X	X	X	X	E	N					
Ethyl Pentachlorobenzene	X	X	X	X	X	X	X	E	N					
Ethyl Phthalate	X	X	N	X	G	N	N	E	N					
Ethyl Propionate	X	N	X	X	X	N	X	N	N					
Ethyl Silicate	G	G	E	E	N	N	G	E	N					
Ethylamine	F	F	N	N	G	F	N	N	E					
Ethylbutanol	N	N	E	E	E	G	E	E	E					
Ethylene Bromide	X	X	X	X	X	X	X	G	G					
Ethylene Chloride	X	X	X	X	X	X	X	G	G					
Ethylene Chlorohydrin	N	N	X	X	G	N	X	E	N					
Ethylene Diamine	G	G	E	E	E	F	E	E	E					
Ethylene Dibromide	X	X	X	X	X	X	X	G	F					
Ethylene Dichloride	X	X	X	X	X	X	X	G	G					
Ethylene Glycol	E	E	E	E	E	E	E	E	E					
Ethylene Glycol Monoethylether	N	N	N	N	N	N	E	E	N					
Ethylene Glycol Monoethylether Acetate	N	N	N	N	N	N	E	E	N					
Ethylene Glycol Monomethyl Ether	N	N	N	N	N	N	E	E	N					
Ethylene Glycol N-Butyl Ether	N	N	N	N	N	N	E	E	N					
Ethylene Oxide	X	X	X	X	X	X	C	C	C					
Ethylenediaminetetraacetic Acid (EDTA)	N	N	N	N	N	N	E	E	N					
Ethylene Trichloride (trichloroethylene)	X	X	X	X	C	X	X	G	G					
Ethyl Formate	X	X	X	X	G	X	C	E	E					
Ethyl Hexanol	E	E	E	E	E	E	E	E	E					
Ethyl Methyl Ketone	C	X	X	X	G	X	G	E	E					
Ethyl Oxalate	E	E	X	X	E	X	G	E	E					
Ethyl Propyl Ether	X	X	X	X	X	X	X	E	E					
Ethyl Propyl Ketone	X	X	X	X	G	X	G	E	E					
Ethyl Sulfate	X	X	X	X	G	X	G	E	E					
Ethylhexanediol	N	N	N	N	N	N	G	E	N					
Ethylhexoic Acid	N	N	N	N	N	N	N	G	E					
Ethylhexyl Acetate	N	N	X	X	N	X	E	E	N					
Ethylhexyl Acrylate	N	N	N	X	N	N	N	G	N					

\* RAGCO supports the autonomy of its locations to select the best products to service their markets. Subtle variations of these specifications may exist. Contact your RAGCO affiliate for confirmation.





# CHEMICAL COMPATIBILITY RUBBER

	N	S	N	I	C	P	L	U
	B	B	B	B	B	B	B	H
	C	C	C	C	C	C	C	X
	R	R	R	R	R	R	R	M
	R	R	R	R	R	R	R	E
Ethylhexyl Alcohol	E	E	E	N	E	N	E	E
Ethylhexyl Phosphorodieth	X	N	N	E	X	X	X	N
EX. TRI (Trichloroethylene)	X	X	X	C	X	X	X	G
Fatty Acids	X	X	C	C	X	X	X	E
Fatty Alcohol, Blend	E	E	E	E	E	N	E	E
Fatty Petroleum Alcohol	N	N	N	E	E	N	E	E
Ferric Bromide	E	N	N	N	N	N	N	N
Ferric Chloride	E	E	E	E	E	E	E	E
Ferric Nitrate	N	N	G	G	G	G	G	E
Ferric Sulfate	E	E	E	E	E	E	E	E
Ferrous Acetate	X	X	X	X	E	X	G	E
Ferrous Ammonium Sulfate	E	E	E	E	E	E	E	E
Ferrous Chloride	E	E	E	E	E	E	E	E
Ferrous Hydroxide	G	C	E	G	E	G	E	E
Ferrous Nitrate	N	N	G	G	G	G	G	E
Ferrous Sulfate	E	E	E	E	E	E	E	E
Fertilizer (Liquid Manure)	E	E	E	E	E	E	E	E
Fire-Resistant Hydra-Fluid (Texaco)	N	N	N	E	X	N	X	E
Fish Oil	X	X	E	E	E	E	E	E
Fluoroboric Acid	E	C	G	E	E	E	E	E
Fluorine	X	X	X	X	X	X	X	X
Fluosillicic Acid	E	C	G	E	E	E	E	E
Formaldehyde	C	C	G	G	E	C	G	E
Formalin (37-50% HCHO w/15% MeOH)	X	X	G	G	G	G	E	N
Formamide	E	E	E	E	E	E	E	E
Formic Acid	G	G	C	X	E	F	E	C
FR Fluid D	N	N	N	E	X	N	X	E
Freon So 2	N	N	E	N	N	N	E	N
Freon 11	X	X	G	E	X	E	X	E
Freon 12	X	X	G	G	X	X	X	G
Freon13	E	E	E	E	E	E	E	E
Freon 21	X	X	G	X	X	X	X	E
Freon 22	X	X	X	E	E	X	E	E
Freon 31	G	G	E	X	E	G	E	E
Freon 32	E	E	E	E	E	E	E	E
Freon 112	X	X	G	G	X	G	X	E
Freon 113	C	G	E	E	X	E	X	E
Freon 114	E	E	E	E	E	E	E	E
Freon 115	E	E	E	E	E	E	E	E
Freon 142b	E	E	E	E	E	E	E	E
Freon 152b	E	E	E	E	E	C	E	E
Freon 218	E	E	E	E	E	E	E	E
Freon C316	E	E	E	E	E	E	E	E
Freon C318	E	E	E	E	E	E	E	E
Freon 1381	E	E	E	E	E	E	E	E
Freon 114B2	X	C	E	G	X	E	X	E
Freon 502	E	E	E	G	E	E	E	E
Freon TF	C	G	E	E	E	E	E	E
Freon T-WD602	C	G	G	E	E	G	G	E
Freon TMC	G	C	G	G	G	G	G	E
Freon T-P35	E	E	E	E	E	E	E	E
Freon TA	E	E	E	E	E	E	E	E
Freon TC	X	G	E	E	E	E	G	E
Freon BF	X	X	G	G	X	G	X	E
Freon MF	X	G	C	E	X	G	X	E
Fuel A (ASTM)	X	X	G	E	X	F	X	E
Fuel B (ASTM)	X	X	F	E	X	X	X	G

	N	S	N	I	C	P	L	U
	B	B	B	B	B	B	B	H
	C	C	C	C	C	C	C	X
	R	R	R	R	R	R	R	M
	R	R	R	R	R	R	R	E
Fuel C (ASTM)	X	X	C	G	X	X	X	G
Fuel Oil	X	X	G	E	X	E	X	E
Fumaric Acid	E	E	G	E	X	G	X	E
Furan	X	X	X	X	C	X	C	E
Furfural	X	X	C	X	G	G	G	E
Furfuryl Alcohol	X	X	C	X	C	C	C	E
Fyrguard 150, 200	N	N	N	E	E	N	E	N
Fyrquel 15R & O, 220 R&O, 550R&O	N	N	N	E	E	N	E	N
Fyrquel 90, 150, 220, 550, 1000	N	N	N	E	E	N	E	N
Gallic Acid	E	E	G	G	G	G	G	E
Gasohol	X	X	G	G	X	X	X	G
Gasoline (oxgenated-blended with MTBE)	X	X	G	G	X	X	X	G
Gasoline - Regular	X	X	E	E	X	C	X	E
Gasoline - Hi-Test	X	X	G	E	X	X	X	E
Gasoline - Lead Free	X	X	G	G	X	X	X	E
Gasoline (White)	X	X	G	G	X	X	X	G
Gas, Coal	N	N	N	N	N	N	N	N
Gas, High Octane	X	X	G	E	X	X	X	E
Gelatin	E	E	E	E	E	E	E	E
Glacial Acetic Acid	N	N	X	N	X	N	G	E
Glauber's salt	E	E	N	N	N	N	E	N
Gluconic Acid	X	X	C	C	C	G	C	E
Glucose	E	E	G	G	E	E	G	E
Glue	E	E	E	E	E	E	E	E
Glycerine (Glycerol)	E	E	E	E	E	E	E	E
Glycerol Monolaurate	N	N	N	N	E	N	E	E
Glycol FR Fluids	N	N	N	E	E	N	E	N
Glycols	E	E	E	E	E	E	E	E
Glyphosate	N	N	N	N	N	N	E	N
Graffinite	X	N	N	E	X	X	X	N
Graphite	E	N	N	N	N	N	N	E
Grease	X	X	X	X	F	X	E	G
Green Sulfate Liquor	E	E	G	E	E	E	E	E
Halium	E	E	E	E	E	E	E	N
Halowax Oil	X	X	X	X	X	X	X	E
Heptachlor in Petroleum Solvents	X	X	G	G	X	X	X	E
Heptachlor in Petroleum Solvents (Water Spray)	X	X	G	G	X	X	X	E
Heptanal (Heptaldehyde)	X	X	X	X	X	X	G	E
Heptane	X	X	E	E	X	G	X	E
Heptane Carboxylic Acid	X	N	N	X	X	G	N	E
Heptanol	E	E	E	E	E	E	E	E
Hexaldehyde	N	N	N	N	N	N	E	E
Hexane	X	X	E	E	X	F	X	E
Hexanol	E	E	E	E	E	E	E	E
Hexene	X	X	G	G	X	G	X	E
Hexylamine	G	C	G	G	G	C	G	E
Hexylene	X	X	G	E	X	X	C	G
Hexylene Glycol	E	E	E	E	E	E	E	E
Hexyl Methyl Ketone	X	X	X	X	G	X	G	E
Hi-Tri (Trichloroethylene)	X	X	X	C	X	X	X	G
Honey	E	N	E	E	N	N	E	N
Houghto-Safe 1055, 1110, 1115, 1120, 1130	N	N	N	X	E	N	E	N
Houghto-Safe 271, 416, 520, 616 & 620	N	N	N	E	E	N	E	N
Houghto-Safe 5046	N	N	N	E	E	N	X	E
Houghto-Safe 625, 640, & 525 under 100°F	N	N	N	E	E	N	E	N
Hy-Chock Oil	N	N	N	E	N	N	N	E





# CHEMICAL COMPATIBILITY RUBBER

	U H E X M										
	S	N	I	C	P	L	W				
	N	B	C	B	I	S	D	P	P		
	R	R	R	R	R	M	M	E	E		
Hydrafluid 760 (Texaco & Houghton)	N	N	N	E	X	N	X	E	N		
Hydrafluid AZR&O, A, B, AA, C	N	N	N	E	X	N	X	E	N		
Hydrasol A (Textile Drying)	N	N	N	E	X	N	X	E	N		
Hydraulic Fluid (Petroleum)	X	X	G	E	X	G	X	E	E		
Hydraulic Fluid (Phosphate Ester Based)	X	X	X	X	E	X	E	E	E		
Hydraulic Fluid (Poly Alkylene Glycol Base)	G	G	E	E	E	E	E	E	E		
Hydraulic & Motor Oil	X	X	C	E	X	G	X	E	E		
Hydrazine	X	X	X	X	G	X	G	E	N		
Hydrazine Hydrate	X	X	X	X	G	X	G	E	N		
Hydrazine Solution	X	X	X	X	G	X	G	E	N		
Hydrobromic Acid	E	X	X	F	E	E	G	E	E		
Hydrochloric Acid 37%	E	X	X	X	F	X	X	E	E		
Hydrochloric Acid 50%	E	C	X	X	G	E	C	E	E		
Hydrochloric Acid 100%	G	C	X	X	C	G	C	E	E		
Hydrocyanic Acid	G	F	E	F	E	E	C	E	E		
Hydro-Drive Oil (Houghton)	N	N	N	E	X	N	X	N	N		
Hydrofluoric Acid	X	X	X	X	E	E	X	C	E		
Hydrogen Chloride Anhydrous	N	N	N	N	N	N	N	N	N		
Hydrogen Bromide Liquid	X	X	N	X	X	N	E	N	N		
Hydrogen Dioxide 10%	X	X	N	N	F	N	N	N	G		
Hydrogen Fluoride	X	X	N	X	G	N	E	N	N		
Hydrogen Gas	X	X	N	X	G	N	E	N	N		
Hydrogen peroxide 3%	E	C	G	G	E	E	G	E	E		
Hydrogen Peroxide 10%	X	X	C	X	C	C	C	E	E		
Hydrogen Peroxide 30%	X	X	X	X	X	X	C	E	E		
Hydrogen Peroxide 90%	X	X	X	X	X	X	C	G	G		
Hydrogen Sulfide	X	X	E	X	E	G	E	E	E		
Hydrolube	N	N	G	E	G	N	E	N	E		
Hydroquinine	G	G	X	X	G	C	G	E	E		
Hydroxyacetic Acid Solution	N	N	N	N	N	N	G	E	E		
Hydroxyethyl Acrylate (HEA)	N	N	N	N	N	N	X	E	E		
Hydroxyethyl Acrylate Acid (HEA Acid)	N	N	N	N	N	N	X	E	E		
Hydroxypropyl Acrylate Acid	N	N	N	N	N	N	X	E	E		
Hylene	X	X	X	X	G	X	G	N	N		
Hypochlorous Acid	G	G	G	X	G	E	G	E	E		
Ink Oil (Linseed Oil Base)	X	X	G	G	G	G	G	E	E		
Insulating Oil	X	X	G	E	X	X	X	E	E		
Iodine	X	X	X	X	X	F	X	E	E		
Iron Acetate	X	X	X	X	E	X	G	E	E		
Iron Hydroxide	C	C	E	G	E	G	G	E	E		
Iron Salts	E	E	E	E	E	E	E	E	E		
Iron Sulfate	E	E	E	E	E	E	E	E	E		
Iron Sulfide	E	E	E	E	E	E	E	E	E		
Isoamyl Acetate	X	X	X	X	E	X	G	E	E		
Isoamyl Chloride	X	X	X	X	C	X	X	G	G		
Isoamyl Ether	X	X	X	X	X	X	X	E	E		
Isoamyl Phthalate	X	X	X	X	E	X	G	E	E		
Isobutane	X	X	E	E	X	X	E	E	E		
Isobutanol (Isobutyl Alcohol)	E	E	E	E	E	E	E	E	E		
Isobutyl Acetate	X	X	X	X	E	X	G	E	E		
Isobutyl Aldehyde	C	X	X	X	G	X	G	E	E		
Isobutyl Amine	G	C	X	X	G	C	G	E	E		
Isobutyl Bromide	X	X	X	X	X	X	X	G	G		
Isobutyl Carbinol	E	E	G	E	E	E	E	E	E		
Isobutyl Chloride	X	X	X	X	X	X	X	G	G		

	U H E X M										
	S	N	I	C	P	L	W				
	N	B	C	B	I	S	D	P	P		
	R	R	R	R	R	M	M	E	E		
Isobutylene	X	X	X	X	E	X	X	E	E		
Isobutyl Ether	X	X	X	X	X	X	X	E	E		
Isocyanates	C	X	X	X	G	C	G	G	G		
Isooctane	X	X	E	E	X	G	X	E	E		
Isooctyl Alcohol	N	N	N	N	N	N	E	E	E		
Isooctyl Thioglycolate	N	N	N	N	N	N	G	E	N		
Isopentane	X	X	E	E	X	X	X	G	G		
Isophorone	N	N	N	X	E	N	E	G	G		
Isopropyl Amine	G	X	E	C	G	C	G	E	E		
Isopropyl Acetate	X	X	X	X	E	C	G	E	E		
Isopropyl Alcohol (Iso-propanol)	E	E	E	E	E	E	E	G	G		
Isopropyl Amine	G	X	E	C	G	C	G	E	E		
Isopropyl Benzene	X	X	X	X	X	X	X	E	E		
Isopropyl Chloride	X	X	X	X	X	X	X	G	G		
Isopropyl Ether	X	X	X	C	X	C	X	E	E		
Isopropyl Toluene	X	X	X	X	X	X	X	E	E		
Jet Fuels	X	X	G	E	X	F	X	E	E		
Kerosene	X	X	C	E	X	F	X	E	E		
Ketchup	N	N	E	E	N	N	N	N	N		
Ketoglutaric Acid	N	N	N	N	N	N	G	E	E		
Ketones	G	G	X	X	G	X	E	E	E		
Lacquer	X	X	X	X	X	X	N	N	N		
Lacquer Solvents	X	X	X	X	X	X	X	E	E		
Lactic Acid - Cold	G	G	E	X	E	G	X	C	N		
Lactic Acid - Hot	X	X	X	X	N	C	X	N	N		
Lactol	N	N	G	G	N	N	N	E	N		
Lard	X	X	G	E	X	X	C	E	E		
Lasso (Alachlor)	N	N	N	N	N	N	N	E	N		
Latex Paint	G	G	N	E	G	N	E	E	E		
Lauryl Alcohol	E	E	E	E	E	E	E	E	E		
Lavender Oil	X	X	X	G	X	X	X	G	N		
Lead Acetate	X	X	G	G	E	X	G	E	E		
Lead Nitrate	E	E	E	E	E	E	E	E	E		
Lead Sulfamate	G	G	E	G	E	G	E	E	E		
Lead Sulfate	E	E	E	E	E	E	E	E	E		
Lead, Tetraethyl	X	X	X	G	X	X	X	G	N		
Lead, Tetramethyl	X	X	X	G	X	X	X	N	N		
Lecithin	N	N	G	X	N	N	N	E	N		
Ligroin	X	X	E	E	X	X	X	E	E		
Lime	X	X	C	F	E	E	E	G	E		
Lime, Chlorinated	G	G	X	G	G	X	G	E	E		
Lime Sulphur Solution	X	X	E	X	X	G	G	E	E		
Limonene	X	X	N	X	N	N	X	G	E		
Lindol (Tricresyl Phosphate)	X	X	X	X	E	G	E	E	E		
Linoleic Acid	X	X	X	X	X	X	X	N	N		
Linseed Oil	X	X	G	E	E	C	G	E	E		
Liquid Petroleum Gas	X	X	G	E	X	G	X	E	E		
Liquid Soap	E	E	E	E	E	E	E	E	E		
Liquified Natural Gas	X	X	X	X	X	X	X	X	X		
Lubrication Oils	X	X	C	E	X	F	X	E	E		
Lye Solution	G	G	G	E	E	E	E	E	G		
Machine Oil Under 135°F	X	X	E	E	X	G	X	E	N		
Maganese Salts	X	X	N	E	N	E	N	E	N		
Magnesium Acetate	X	X	X	X	E	X	G	E	E		
Magnesium Carbonate	E	E	E	E	E	E	E	E	E		
Magnesium Chloride	E	E	E	E	E	E	G	E	E		
Magnesium Chloride Brine	E	N	N	E	N	N	E	E	E		

\* RAGCO supports the autonomy of its locations to select the best products to service their markets. Subtle variations of these specifications may exist. Contact your RAGCO affiliate for confirmation.





# CHEMICAL COMPATIBILITY RUBBER

	S	N	I	C	P	L	W	U
	N	B	C	B	I	S	D	P
	R	R	R	R	R	M	M	E
Magnesium Hydrate	E	G	E	G	E	G	E	E
Magnesium Hydroxide	E	E	E	E	E	E	G	E
Magnesium Nitrate	E	E	E	E	E	E	E	E
Magnesium Oxide, Slurry	G	N	E	G	N	N	E	N
Magnesium Sulfate	E	E	E	E	E	E	E	E
Malathion 50 in Aromatic Solvents	X	X	C	C	X	X	X	E
Malathion 50 in Aromatic Solvents, (Water Spray)	X	X	E	E	X	X	X	E
Maleic Acid	X	X	X	F	X	F	F	G
Maleic Anhydride	X	X	C	X	C	X	C	E
Malic Acid	E	G	C	G	X	G	X	E
Malt Extract (Maltine)	N	N	N	N	N	N	E	E
Manganese Sulfate	E	E	E	E	E	E	E	E
Manganese Sulfide	C	E	G	E	E	E	G	E
Manganese Sulfite	C	E	G	E	E	E	G	E
Maxmul (Penzoil Hydraulic Fluid)	N	N	G	E	N	N	N	N
Mek	G	X	X	X	G	X	G	E
Mercuric Chloride	G	G	C	C	G	G	C	E
Mercuric Cyanide Solutions	G	G	E	G	G	E	G	N
Mercurous Nitrate Solutions	N	N	N	N	N	N	G	E
Mercury	E	E	E	E	E	E	E	E
Mercury Vapors	E	E	E	E	E	E	E	E
Mesityl Oxide (Methyl Isobutenyl Ketone)	X	X	X	X	G	X	G	E
Mesitylene	X	X	X	X	X	N	X	N
Metallic Soaps	X	X	N	E	X	G	X	E
Methacrylic Acid	X	X	G	X	G	C	G	E
Methyl Alcohol	G	N	N	E	G	G	N	N
Methane	X	X	G	E	X	G	X	E
Methanoic Acid	N	N	N	N	N	N	E	N
Methanol (Methyl Alcohol)	X	X	X	X	X	X	X	G
Methyl Acetate	F	X	X	X	G	X	G	E
Methyl Acetoacetate	X	N	X	X	G	X	G	N
Methyl Acetone	X	N	N	X	G	X	E	N
Methyl Acrylate	C	X	C	X	G	X	G	E
Methacrylic Acid	X	X	N	G	E	N	G	E
Methylaniline	N	N	X	X	N	G	G	E
Methyl Alcohol (Methanol)	X	X	X	X	X	X	X	G
Methylalyl Alcohol	G	N	N	E	G	G	N	N
Methylamine (30-40% in water)	N	N	N	X	N	N	G	E
Methyl Benzene (Toluene)	X	X	X	X	X	X	X	E
Methyl Bromide	X	X	X	G	G	X	G	E
Methyl Butanethiol	X	X	N	N	X	N	X	E
Methyl Butanol	N	N	N	E	E	N	E	E
Methyl Butyl Ketone	X	X	X	X	G	X	G	E
Methyl Carbitol	X	X	N	N	X	X	E	N
Methyl Cellosolve	X	X	G	C	G	C	G	E
Methyl Chloride	X	X	X	F	X	X	E	G
Methyl Chloroform	X	X	X	X	X	X	X	G
Methyl Chloroformate	X	X	X	X	X	X	N	N
Methyl Cyclohexane	X	X	X	X	X	X	G	G
Methyl Ethyl Acetate	X	N	N	X	E	G	X	E
Methyl Ethyl Alcohol	E	N	N	E	E	E	E	E
Methyl Ethyl Carbinol	E	N	N	E	E	E	E	E
Methyl Ethyl Ketone	X	N	N	X	G	X	N	E
Methyl Hexanone	X	N	N	X	G	X	N	N
Methylcyanide	N	N	N	N	N	N	X	N
Methylene Bromide	X	X	X	X	X	X	X	G

	S	N	I	C	P	L	W	U
	N	B	C	B	I	S	D	P
	R	R	R	R	R	M	M	E
Methylene Chloride	X	X	X	X	X	X	X	E
Methylene Dichloride	X	X	X	X	X	X	X	E
Methyl Ethyl Ketone (MEK)	G	X	X	X	G	X	G	E
Methyl Formate	C	C	G	X	G	C	G	G
Methyl Hexanol	E	E	E	E	E	E	E	E
Methyl Hexyl Ketone	X	X	X	X	G	X	G	E
Methyl Isoamyl Ketone	X	N	N	X	G	X	N	N
Methyl Isobutenyl Ketone	X	X	X	X	G	X	G	E
Methyl Isobutyl Carbinol	G	C	G	G	E	G	E	E
Methyl Isobutyl Ketone (MIBK)	X	X	X	X	G	X	G	E
Methyl Isopropyl Ketone	X	X	X	X	G	X	G	E
Methyl Methacrylate	X	X	X	X	X	G	G	N
Methyl Methacrylate Monomer, Inhibited	X	X	X	X	X	X	X	N
Methyl Normal Amyl Ketone	X	N	N	X	G	X	G	E
Methyl Phenol	X	X	X	X	G	X	N	G
Methyl Propyl Carbinol	E	E	E	E	E	E	E	E
Methyl Propyl Ether	X	X	X	X	X	X	X	E
Methyl Propyl Ketone	X	X	X	X	G	X	G	E
Methyl Salicylate	X	X	X	X	G	X	G	G
Methyl Sulfate	X	X	X	X	G	X	X	E
Methyl Tertiary Butyl Ether (MTBE)	X	X	X	X	X	X	X	E
Methylalyl Acetate	X	N	N	X	E	G	E	E
Methylalyl Chloride	X	N	N	X	X	X	N	G
Methyldiethanolamine	X	N	N	E	X	X	X	E
Metribuzin	N	N	N	N	N	N	E	N
Mineral Oil	X	X	C	E	X	G	X	E
Mineral Spirits	X	X	G	E	X	X	X	E
Molasses	G	G	G	G	E	E	E	N
Molten Sulfur	X	X	N	N	G	F	X	N
Monochlorobenzene	X	X	X	X	X	X	X	G
Monochlorodifluoromethane (Freon 22)	X	X	E	X	E	X	E	E
Monoethanolamine	G	C	G	C	G	G	G	E
Monochloroacetic Acid	G	N	N	X	X	X	X	E
Monoethylamine	X	X	X	X	G	X	E	N
Monoisopropanol Amine	G	N	N	G	E	X	N	E
Monomethylether	G	G	E	E	E	C	C	E
Monopentaerythritol Solution	N	N	N	N	N	N	E	E
Monosodium Phosphate	G	G	X	N	G	N	G	E
Monovinyl Acetate	X	X	X	X	G	C	C	E
Morpholine	N	N	N	X	N	N	X	N
Motor Oil - 40W	X	X	E	E	X	X	X	E
Muriatic Acid	E	X	X	X	F	X	F	E
Mustard	E	E	E	N	E	E	N	N
N-Octane	X	X	G	G	X	X	X	G
Naphta	X	X	G	E	X	X	X	E
Naphtialene	X	X	X	X	X	X	X	E
Naphtenic Acids	X	X	X	G	X	X	X	E
Natural Gas	X	X	F	F	X	F	X	C
Neatsfoot Oil	X	X	G	E	G	G	G	E
Neohexane	N	N	G	E	N	N	X	N
Neon Gas	E	E	E	E	E	E	X	N
Neu-Tri (Trichloroethylene)	X	X	X	C	X	X	X	G
Neutral Oil	X	X	G	G	X	N	X	E
Nickel Acetate	X	X	X	X	E	X	G	E
Nickel Chloride	E	E	E	E	E	E	E	E
Nickel Nitrate	E	E	E	E	E	E	E	E
Nickel Plating Solution	E	X	C	G	G	G	G	E





# CHEMICAL COMPATIBILITY RUBBER

	S N I C P L W										S N I C P L W									
	N	B	C	R	R	R	R	R	R	R	N	B	C	R	R	R	R	R	R	R
	R	R	R	R	R	R	R	R	R	R	R	R	R	R	R	R	R	R	R	R
Nickel Salts	E	E	E	E	E	E	E	E	E	N	Peanut Oil	X	X	G	E	C	G	X	E	E
Nickel Sulfate	E	E	E	E	E	E	E	E	E	E	Pelargonic Acid	X	N	N	E	E	X	N	E	E
Niter Cake	E	E	E	E	E	E	E	E	E	E	Pentachloroethane	X	X	N	N	X	X	N	E	E
Nitric Acid, Conc (16N)	X	X	X	X	G	G	E	G	N		Pentachlorophenol in Oil	X	X	X	X	E	N	X	E	E
Nitric Acid, Red Fuming	X	X	X	X	X	X	X	X	X		Pentane	X	X	E	E	X	G	X	E	E
Nitric Acid - 10%	X	X	X	X	G	G	G	E	E		Pentanol	E	N	N	E	E	E	E	E	E
Nitric Acid - 13N	N	N	N	N	N	N	N	C	N	N	Pentatone	X	N	N	X	G	X	N	E	E
Nitric Acid - 13N + 5%	N	N	N	N	N	N	N	N	N		Perchloric Acid - 2N	G	G	E	X	G	E	C	E	E
Nitric Acid - 20%	X	X	X	X	G	G	F	E	E		Perchloroethylene	X	X	X	X	X	X	X	G	G
Nitric Acid - 30%	X	X	X	X	F	F	F	G	G		Petrolatum	X	X	E	E	X	C	X	E	E
Nitric Acid - 30% to 70%	X	X	X	X	F	F	C	F	F		Petroleum, Crude	X	X	G	E	X	X	X	E	E
Nitrobenzene	X	X	X	X	X	X	X	E	E		Petroleum Ether (Naphtha)	X	X	E	E	X	X	X	E	E
Nitroethane	G	G	C	X	G	G	X	E	N		Petroleum Naptha	X	X	X	X	X	X	X	X	X
Nitrogen Gas	E	E	E	E	E	E	E	E	E		Petroleum Oils	X	X	E	E	X	C	X	E	E
Nitrogen Oxide	X	X	X	X	E	E	E	G	E	N	Petroleum Paraffin Wax	N	N	N	N	N	N	X	G	G
Nitrogen Tetraoxide	X	X	X	X	X	X	X	X	X		Phenol	F	F	F	X	E	F	F	E	E
Nitromethane	G	G	C	X	G	C	G	E	E		Phenol Acid	X	X	X	X	G	X	G	G	N
Nitropropane	C	C	C	X	E	C	G	E	E		Phenolates	N	N	X	X	N	X	N	N	N
Nitrous Oxide Gas	E	E	E	E	E	E	E	E	E		Phenolsulfonic Acid	X	X	C	X	C	X	C	G	G
Nonenes	X	N	N	E	X	X	X	E	E		Phenyl Chloride	X	X	X	X	X	X	X	E	E
Octadecanoic Acid	X	X	G	E	G	X	C	E	E		Phenylhydrazine	C	X	X	X	G	C	C	E	E
Octane	X	X	G	E	X	X	X	G	G		Phorone	X	X	X	X	E	X	G	E	E
Octanol (Octyl Alcohol)	G	G	E	G	G	G	G	E	E		Phosgene (Carbonyl Chloride)	X	X	X	X	G	X	X	X	X
Octyl Acetate	X	X	X	X	E	X	G	E	E		Phosphate Esters	X	X	X	X	E	X	E	E	E
Octyl Aldehyde	X	N	N	X	X	X	N	N	N		Phosphoric Acid 10%	E	E	E	E	E	E	E	E	E
Octyl Amine	C	C	G	C	G	C	G	E	E		Phosphoric Acid 10% - 85%	F	F	G	F	E	E	E	E	E
Octyl Carbinol	E	E	E	E	E	E	E	E	E		Phosphorous Trichloride	X	X	X	X	E	X	E	E	E
Octylene Glycol	E	E	E	E	E	E	E	E	E		Pickling Solution	C	C	C	C	C	C	C	E	E
Oil, ASTM #1	X	X	E	E	X	G	X	E	E		Pitric Acid, Molten	C	C	C	C	C	G	C	X	X
Oil, ASTM #2	X	X	E	E	X	C	X	E	E		Pitric Acid, Water Solution	E	C	G	G	E	E	G	E	E
Oil, ASTM #3	X	X	C	G	E	X	X	E	E		Pine	X	X	X	E	X	X	X	E	E
Oil - Petroleum	X	X	E	E	X	F	X	E	E		Pine Oil	X	X	X	F	F	X	X	E	E
Oil of Turpentine	X	X	G	E	X	X	X	G	G		Piperidine	X	X	X	X	X	X	X	G	G
Oils, Animal (high fatty acid content)	X	X	G	E	G	X	X	G	N		Pitch	X	X	G	G	X	C	X	E	E
Oleic Acid	X	X	F	C	G	X	G	E	E		Plating Solutions, Chrome	X	X	G	G	E	C	E	E	E
Oleum (Fuming Sulf Acid)	X	X	X	X	X	X	X	X	X		Plating Solutions, Other	E	E	G	G	E	C	E	E	E
Olive Oil	X	X	G	E	E	G	G	E	E		Polyvinyl Acetate Emulsion (PVA)	C	C	G	C	E	G	E	E	E
Organic Fatty Acids	X	N	N	E	X	X	X	E	E		Polyethylene Glycol	E	E	E	E	E	E	E	E	E
Ortho-Dichlorobenzene	X	X	X	X	X	X	X	E	E		Polypropylene Glycol	E	E	E	E	E	E	E	E	E
Orthodichlorobenzol	X	N	N	X	X	X	X	E	E		Polyurethane Foam Under 125°F	N	N	N	N	G	N	G	E	N
Orthoxylene	X	X	N	N	X	X	X	E	G		Potassium Acetate	X	X	X	X	E	X	G	E	E
OS 45 Hydraulic Fluid (Silicate Ester Base)	X	X	E	G	X	G	X	N	N		Potassium Bicarbonate	E	E	E	E	E	E	E	E	E
Oxalic Acid	F	F	G	F	E	G	E	E	E		Potassium Bisulfate	E	E	E	E	E	E	E	E	E
Oxygen, Cold	G	G	G	G	E	G	G	E	E		Potassium Bisulfite	E	E	E	E	E	E	E	E	E
Oxygen, Hot	X	X	X	X	X	X	X	E	E		Potassium Bromide	E	E	E	E	E	E	E	E	N
Ozone	X	F	G	X	G	E	E	E	E		Potassium Carbonate	E	E	E	E	E	E	E	E	E
Paint Thinner	X	X	X	X	X	X	X	E	E		Potassium Chloride	E	E	E	E	E	E	E	E	E
Paint (Emulsion or Latex)	N	N	N	G	N	N	G	E	E		Potassium Chromate	X	X	F	X	E	F	G	G	G
Paint (Oil or Solvent Based)	X	X	N	G	X	X	X	E	N		Potassium Cyanide	E	E	E	E	E	E	E	E	E
Palmitic Acid	X	X	C	E	E	C	C	G	E		Potassium Dichromate	X	X	G	X	E	F	G	E	E
Palm Oil	X	X	G	E	E	G	G	E	E		Potassium Hydrate	E	G	G	G	E	G	E	E	E
Papermakers Alum	E	E	E	E	E	E	E	E	E		Potassium Hydroxide	E	E	C	E	E	E	E	E	E
Para-Dichlorobenzene	X	X	X	X	X	X	X	G	G		Potassium Iodide	N	N	E	E	N	E	E	N	N
Paraffin Wax	X	X	G	E	X	X	X	X	X		Potassium Nitrate	E	E	E	E	E	E	E	E	E
Paraformaldehyde	X	X	G	G	G	G	G	E	E		Potassium Permanganate 5%	X	X	X	X	E	X	E	E	E
Paraldehyde	X	N	N	X	G	X	G	E	E		Potassium Phosphate	N	N	E	N	N	E	E	N	N
Paraxylene	X	N	N	N	X	X	N	E	E		Potassium Silicate	E	E	E	E	E	E	E	E	E

\* RAGCO supports the autonomy of its locations to select the best products to service their markets. Subtle variations of these specifications may exist. Contact your RAGCO affiliate for confirmation.





# CHEMICAL COMPATIBILITY RUBBER

	U H M									
	S		N		I		C		P	
	N	B	C	R	B	I	S	D	P	P
	R	R	R	R	R	M	M	E	E	E
Potassium Sulfate	E	E	E	E	E	E	E	E	E	E
Potassium Sulfide	E	E	E	E	E	E	E	E	E	E
Potassium Sulfite	E	E	E	E	E	E	E	E	E	E
Potassium Thiosulfate	N	N	E	N	N	E	E	N	N	N
Producer Gas	X	X	G	E	X	G	X	E	E	E
Propane	X	X	C	E	X	G	X	E	N	N
Propanediol	E	E	G	E	E	E	E	E	E	E
Propanol	E	N	N	E	E	E	E	E	E	E
Propionic Acid	G	G	X	X	G	G	G	E	E	E
Propyl Acetate	X	X	X	X	G	X	G	E	E	E
Propyl Alcohol (Propanol)	E	E	E	E	E	E	E	E	E	E
Propyl Aldehyde	X	N	N	X	G	X	N	N	N	N
Propyl Chloride	X	X	C	X	C	X	C	G	G	G
Propylene	X	X	X	X	X	X	X	N	N	N
Propylene Diamine	G	G	G	G	E	C	G	E	E	E
Propylene Dichloride	X	X	X	X	X	X	X	G	G	G
Propylene Glycol	E	E	E	E	E	E	E	E	E	E
Propylene Tetramer	X	N	N	E	X	X	X	E	E	E
Purina Insecticide	N	N	X	X	G	N	G	E	N	N
Puropale RX Oils	N	N	N	E	X	N	X	E	N	N
Pydraul Hydraulic Fluids	X	X	X	X	G	X	G	G	G	G
Pyranol	X	X	X	C	X	X	X	E	E	E
Pyrene (Carbon Tetrachloride)	X	X	X	X	X	X	X	G	X	X
Pyridine	X	X	X	X	G	X	G	E	E	E
Pyroligneous Acid	C	C	G	C	G	G	G	E	E	E
Pyrrrole	C	G	X	X	G	X	C	E	E	E
Quenching Oil	N	N	G	G	N	N	N	N	N	N
Quintolubric 822	N	N	G	E	X	N	G	E	N	N
Rando Oils	N	N	N	E	X	N	X	E	N	N
Rape Seed Oil	X	X	G	G	E	G	G	G	G	G
Red Oil (Crude Oleic Acid)	X	X	G	G	G	G	G	E	E	E
Refined Wax (Petroleum)	X	X	G	E	N	N	N	E	N	N
Refrigerant 11 - Freon	X	X	C	E	X	F	F	G	G	G
Refrigerant 12 - Freon	X	X	G	E	X	X	X	G	G	G
Refrigerant 22 - Freon	X	X	E	X	E	X	X	E	E	E
Richfield A Weed Killer 100%	X	X	X	X	X	X	X	G	G	G
Richfield B Weed Killer 33%	X	X	G	G	G	C	X	G	G	G
Rosin Oil	X	X	E	E	X	G	X	E	E	E
Rotenone and Water	E	E	E	E	E	E	E	E	E	E
Rubilene Oils	N	N	N	E	X	N	X	E	N	N
Sal Ammoniac	E	E	E	E	E	E	E	E	E	E
Salicylic Acid	E	G	X	X	E	E	E	E	E	E
Sea Water	E	E	E	E	E	E	E	E	E	E
Sevin	N	N	N	N	N	N	G	G	N	N
Sewage	F	F	G	E	F	E	G	E	E	E
Silicate of Soda	E	E	E	E	E	E	E	E	E	E
Silicone of Soda (Sodium Silicate)	E	E	E	E	E	E	E	E	E	E
Silicate Esters	X	X	E	G	X	E	X	E	E	E
Silicone Greases	E	E	E	E	E	E	E	E	E	E
Silicone Oil	E	F	E	E	E	E	F	E	E	E
Silver Cyanide	N	N	E	N	N	N	N	E	N	N
Silver Nitrate	E	E	E	E	E	E	E	E	E	E
Skelly Solvent	X	X	G	E	X	C	X	E	S	E
Skydrol Hydraulic Fluids	X	X	X	X	E	X	E	E	E	E
Soap, Liquid	G	G	E	E	G	E	E	E	N	N
Soap Oil	N	N	X	X	N	X	N	E	G	G
Soap Solutions	G	E	G	E	E	E	E	E	E	E

	U H M									
	S		N		I		C		P	
	N	B	C	R	B	I	S	D	P	P
	R	R	R	R	R	R	M	M	E	E
Soda Ash	E	E	E	E	E	E	E	E	E	E
Soda, Caustic (Sodium Hydroxide)	E	G	E	G	E	E	E	E	E	E
Soda Lime	E	E	G	G	E	G	E	E	E	E
Soda Niter (Sodium Nitrate)	E	E	E	E	E	E	E	E	E	E
Sodium Acetate	X	X	X	X	X	X	X	G	E	E
Sodium Aluminate	E	E	E	E	E	E	E	E	E	E
Sodium Bicarbonate	E	E	E	E	E	E	E	E	E	E
Sodium Bichromate Solution	G	G	G	G	E	G	E	E	N	N
Sodium Bisulfate	E	E	E	E	E	E	E	E	E	E
Sodium Bisulfite	E	E	E	E	E	E	E	E	E	E
Sodium Borate	E	E	E	E	E	E	E	E	E	E
Sodium Carbonate	E	E	E	E	E	E	E	E	E	E
Sodium Chloride	E	E	E	E	E	E	E	E	E	E
Sodium Chloride Solution	G	G	X	X	G	G	X	N	N	N
Sodium Chromate	X	X	C	X	E	C	G	G	G	G
Sodium Cyanide	E	E	E	E	E	E	E	E	E	E
Sodium Dichromate	X	X	C	X	E	F	G	E	E	E
Sodium Fluoride	E	E	E	E	E	E	E	E	E	E
Sodium Hydrate	G	G	G	G	G	G	E	G	N	N
Sodium Hydroxide (Caustic Soda)	E	C	E	G	E	E	E	E	E	E
Sodium Hypochlorite	F	X	X	X	G	F	G	G	G	G
Sodium Metallic	N	N	N	G	N	N	E	N	N	N
Sodium Metaphosphate	E	E	G	E	E	G	E	E	E	E
Sodium Nitrate	E	E	E	E	E	E	E	E	E	E
Sodium Nitrite	E	E	E	E	E	E	E	E	E	E
Sodium Perborate	C	X	G	X	E	X	G	E	E	E
Sodium Peroxide	G	G	G	G	E	G	E	G	G	G
Sodium Phosphate	E	G	G	E	E	E	E	E	E	E
Sodium Silfhydrate	G	X	G	G	G	G	E	G	N	N
Sodium Silicate	E	E	E	E	E	E	E	E	E	E
Sodium Sulfate	E	E	E	E	E	E	E	E	E	E
Sodium Sulfide	E	E	E	E	E	E	E	E	E	E
Sodium Sulfite	E	E	E	E	E	E	E	E	E	E
Sodium Sulphhydrate	N	N	G	G	E	G	E	G	N	N
Sodium Thiocyanate Solution	N	G	E	E	E	G	E	E	N	N
Sodium Thiosulfate	E	E	E	E	E	E	E	E	E	E
Soinus Oils	N	N	N	E	X	N	X	E	N	N
Soybean Oil	X	X	G	G	G	G	E	E	E	E
Spent Acid	X	X	X	X	X	G	X	G	G	G
Stannic Chloride	E	E	E	E	E	E	E	E	E	E
Stannic Sulfide	E	E	E	E	E	E	E	E	E	E
Stannous Chloride	E	E	E	E	G	E	E	E	E	E
Stannous Sulfide	E	E	E	E	E	E	E	E	E	E
Starch	E	E	G	G	N	E	E	E	N	N
Starch Gum	N	N	E	E	X	N	E	E	N	N
Steam - Below 350°F	X	X	X	X	G	X	E	X	X	X
Stearic Acid	X	X	G	G	G	G	E	E	E	E
Stoddards Solvent	X	X	C	E	X	X	X	E	E	E
STPP (Sodium Tripolyphosphate)	G	G	N	N	G	N	G	G	N	N
Styrene	X	X	X	X	X	X	X	X	X	X
Sugar Solutions (Sucrose - Non F.D.A.)	E	E	E	E	E	E	E	E	E	E
Sulfamic Acid	C	C	G	G	E	G	E	E	E	E
Sulfite Liquors	G	G	G	G	E	E	G	E	E	E
Sulfonic Acid	X	X	C	X	X	C	X	G	G	G
Sulfur (Molten)	X	X	X	X	F	F	F	G	G	G
Sulfur Chloride	X	X	C	C	X	G	X	E	G	G
Sulfur Dioxide	F	F	G	X	G	G	F	G	G	G

\* RAGCO supports the autonomy of its locations to select the best products to service their markets. Subtle variations of these specifications may exist. Contact your RAGCO affiliate for confirmation.





# CHEMICAL COMPATIBILITY RUBBER

	U H E X M								
	S	N	I	C	P	L	W		
	N B C	R R R	R R R	R R R	R R R	R R R	R R R	R R R	R R R
	R	R	R	R	R	R	R	R	R
Sulfur Hexafluoride	E	E	E	E	E	E	E	E	E
Sulfur Trioxide	X	X	X	X	G	X	C	G	G
Sulfuric Acid 60% (200°F)	X	X	F	X	F	G	G	E	E
Sulfuric Acid - Conc.	X	X	X	X	X	E	X	E	X
Sulfuric Acid - Fuming	X	X	X	X	X	X	X	X	X
Sulfuric Acid 25%	G	G	G	E	E	E	G	E	E
Sulfuric Acid 25% - 50%	G	X	X	F	E	E	E	E	E
Sulfuric Acid 50% - 96%	X	X	F	X	F	G	G	E	E
Sulfurous Acid	G	C	G	C	G	E	G	E	E
Sun R&O Oils	N	N	N	E	X	N	X	E	N
Suntac HP Oils	N	N	N	E	X	N	X	E	N
Suntac WR Oils	N	N	N	E	X	N	X	E	N
Sunvis Oils 700, 800, 900	N	N	N	E	X	N	X	E	N
Synthetic Oil (Citgo)	N	N	N	E	X	N	X	E	N
Syrup	E	E	G	N	N	N	N	E	E
Tall Oil	X	X	G	E	X	G	X	E	E
Tallow	X	X	E	E	X	X	X	E	E
Tannic Acid	E	G	G	C	E	G	E	E	E
Tar	X	X	G	G	X	X	X	E	E
Tar Bituminous	X	X	C	G	X	X	X	N	N
Tartaric Acid	E	E	G	E	E	E	G	E	E
Tellus Oils	N	N	N	E	X	N	X	E	N
Tergitol	N	N	N	N	N	N	N	N	X
Terpineol	X	X	X	X	C	X	C	G	G
Tertiary Butyl Alcohol	E	E	E	E	E	E	E	E	E
Tetrachlorobenzene	X	X	X	X	X	X	X	G	G
Tetrachloroethane	X	X	X	X	X	X	X	E	G
Tetrachloroethylene	X	X	X	X	X	X	X	E	E
Tetrachloromethane	X	X	X	X	X	X	X	G	G
Tetrachloronaphthalene	X	X	X	X	X	X	X	G	G
Tetradecanol	E	E	E	E	E	E	E	E	E
Tetraethylene Glycol	E	E	E	E	E	E	E	E	E
Tetraethyl Lead	X	X	C	G	X	X	X	E	E
Tetrahydrofuran (THF)	X	X	X	X	X	X	X	E	E
Tetrahydrodicyclopentadiene	X	X	X	X	X	X	X	N	N
Tetralin	X	X	X	X	X	X	X	N	N
Theobromo Oil	X	X	G	G	N	N	N	E	G
Thionyl Chloride	X	X	X	X	X	X	X	E	E
Thiopen	X	X	X	X	G	N	X	N	N
Tin Chloride	E	E	E	E	E	E	E	E	E
Tin Tetrachloride	E	E	E	E	E	E	E	E	E
Titanium Tetrachloride	X	X	G	F	X	F	F	E	G
Toluene	X	X	X	X	X	X	X	E	E
Toluene Diisocyanate (TDI)	C	C	X	C	E	X	E	E	E
Toluidine	X	N	N	X	X	X	N	N	N
Toluol	X	N	N	X	X	X	X	E	E
Toxaphene	X	X	G	G	X	X	X	E	E
Transformer Oils (Petroleum Base)	X	X	G	E	X	G	X	E	E
Transformer Oils (Chlorinated Pheynyl Base Askerels)	X	X	X	X	X	X	X	G	G
Transmission Fluids A	X	X	C	G	X	X	X	E	E
Transmission Fluid B	X	X	X	C	X	X	X	E	E
Tributoxyethyl Phosphate	X	X	N	X	G	X	G	E	X
Tributoxyl Ethylsulfate	X	N	N	X	E	X	E	X	N
Tributyl Amine	G	G	G	G	E	C	E	E	E
Tributyl Phosphate	X	X	X	X	G	X	G	E	E
Tricetin	E	G	G	G	E	G	E	E	E

	U H E X M								
	S	N	I	C	P	L	W		
	N B C	R R R	R R R	R R R	R R R	R R R	R R R	R R R	R R R
	R	R	R	R	R	R	R	R	R
Trichloroacetic Acid	C	G	X	G	G	X	G	E	N
Trichlorobenzene	X	X	X	X	X	X	X	G	G
Trichloroethane	X	X	X	X	X	X	X	E	E
Trichloroethylene	X	X	X	C	X	X	X	G	X
Trichloropropane	X	X	X	X	X	X	X	E	E
Tricresyl Phosphate (TCP)	X	X	X	X	E	X	G	E	E
Tridecanol	E	E	E	E	E	E	E	E	E
Triethanolamine (TEA)	G	G	E	G	E	E	G	E	E
Triethylamine	G	G	E	G	G	E	G	E	E
Triethylene Glycol	E	E	E	E	E	E	E	E	E
Trifluralin	X	N	N	X	X	X	X	E	E
Trihydroxybenzoic Acid	G	G	X	X	G	N	E	E	E
Trimethylbenzene	X	X	X	X	X	N	X	N	N
Trinitrophenol	G	G	G	G	G	G	G	G	G
Trinitrotoluene (TNT)	X	X	G	X	X	G	X	X	X
Triphenyl Phosphate	X	X	C	X	E	C	G	E	E
Tripoly Phosphate	G	G	N	N	G	N	G	G	N
Trisodium Phosphate	E	E	E	E	E	E	E	E	E
Tung Oil	X	X	G	E	C	G	X	E	E
Turbine Oil	X	X	G	G	X	G	X	E	E
Turpentine	X	X	E	E	X	X	X	G	E
2, 4D With 10% Fuel Oil	X	X	E	E	X	X	X	E	E
Ucon Hydrolube Oils	X	X	G	E	E	X	E	E	E
Undecanol	G	N	N	E	N	G	N	N	N
Undecyl Alcohol	G	N	N	E	N	G	N	N	N
Union Hydraulic Tractor Fluid	N	N	N	E	X	N	X	E	N
Unsymmetrical Dimethyl Hydrazine (UDMH)	X	X	X	X	E	E	E	C	C
Uran	G	C	G	G	G	E	G	E	E
Urea	E	F	E	F	E	F	E	E	E
Urethane Formulations	N	N	N	E	N	N	N	N	N
Uric Acid	N	N	N	N	N	N	N	N	N
Varnish	X	X	G	G	X	F	X	E	E
Vegetable Oils	X	X	G	E	E	G	C	E	E
Versilube	C	C	C	E	E	E	E	E	E
Vinegar	E	F	E	C	E	E	G	E	E
Vinegar Acid	E	F	E	F	E	E	G	E	E
Vinyl Acetate	X	X	X	X	G	F	F	G	X
Vinyl Benzene	X	X	X	X	X	X	X	G	G
Vinyl Chloride	F	X	X	X	X	X	X	E	E
Vinyl Cyanide	N	N	N	N	N	N	N	N	N
Vinyl Ether	X	X	X	X	X	C	C	E	E
Vinyl Styrene	N	N	N	N	N	N	N	N	N
Vinyl Toluene	X	X	X	X	X	X	X	G	G
Vinyl Trichloride	X	X	X	X	X	X	X	E	E
Vitrea Oils	N	N	N	E	X	N	X	E	N
V.M. & P. Naptha	X	X	E	E	X	X	X	E	E
Water, Fresh (NON F.D.A.)	E	E	E	E	E	E	E	E	E
Water Boiling	N	N	E	N	N	N	E	N	N
Water, Salt	E	E	E	G	E	E	E	E	E
Whiskey	E	E	E	E	E	E	E	X	N
White Liquor	E	E	E	E	G	E	C	E	E
White Oil	X	X	G	E	X	X	X	E	E
Wines	E	E	E	E	E	E	E	X	N
Wood Alcohol	E	E	E	E	E	E	E	E	E
Xylene (Xytol)	X	X	X	X	X	X	X	C	C
Xylidine	X	X	X	X	X	X	X	G	G

\* RAGCO supports the autonomy of its locations to select the best products to service their markets. Subtle variations of these specifications may exist. Contact your RAGCO affiliate for confirmation.





# CHEMICAL COMPATIBILITY PLASTIC

**WARNING:** The following data has been compiled from generally available sources and should not be relied upon without consulting and following the hose manufacturer's specific chemical recommendations. Neglecting to do so might result in failure of the hose to fulfill its intended purpose. This may result in possible damage to property and serious bodily injury.

MATERIAL CONVEYED	HOSE CONSTRUCTION WITH TEMPERATURE							
	PVC (F°)		TPR (F°)		TPE (F°)		POLYURETHANE (F°)	
	68	104	68	104	68	104	68	104
Acetaldehyde	4	4	4	4	4	4	4	4
Acetaldehyde 40%	4	4	4	4	4	4	4	4
Acetate Solvents, crude	4	4	3	4	3	4	3	4
Acetate Solvents, pure	4	4	3	4	3	4	3	4
Acetic Acid 0-1%	1	2	1	2	3	4	4	4
Acetic Acid 20-30%	1	2	1	2	3	4	4	4
Acetic Acid 80%	2	2	1	2	4	4	4	4
Acetic Acid Vapors	1	2	1	2	3	3	4	4
Acetic Acid Glacial	2	3	2	3	4	4	4	4
Acetic Anhydride	4	4					4	4
Acetone	2	3	1	1	3	4	3	4
Acetylene	1	1					1	1
Acrylonitrile	1	2						
Adipic Acid	2	3					4	4
Allyl Alcohol 96%	4	4					4	4
Allyl Chloride	3	3					4	4
Alum	1	1	1	1	1	1	1	1
Aluminum Acetate	2	3						
Aluminum Alkyl	4	4						
Aluminum Chloride	1	1	1	1	1	1	3	3
Aluminum Flouride	1	1	1	1	1	1	1	1
Aluminum Hydroxide	1		1	1	2	2	2	3
Aluminum Nitrate	1	2					1	1
Aluminum Oxychloride	1	1						
Aluminum Phosphate Solution	4	4						
Aluminum Salts	1	1						
Aluminum Sulphate	1	1	1	1	1	1	1	1
Aminoethanol	2							
Ammonia - aqueous	1		1		3		3	4
Ammonia- dry gas	3	4	2		3		3	4
Ammonia- liquid	4	4	3		3		3	4
Ammoniated Latex	1	3						
Ammonium Acetate	1	1						
Ammonium Bicarbonate	1	1						
Ammonium Carbonate	1	1					1	1
Ammonium Chloride Solution	1	1					2	3
Ammonium Flouride 25%	4	4					3	4
Ammonium Hydroxide (30% NH)	4	4					3	4
Ammonium Metaphosphate	1	1					2	2
Ammonium Persulfate	1	1					2	2
Ammonium Nitrate	1	1					2	2
Ammonium Phosphate Solutions	1	1						
Ammonium Sulfate	1	1					1	1
Ammonium Sulfide	1	1	1	1	1	1	1	1
Ammonium Thiocyanate	1	1	1	1	2	2	2	2
Amyl Acetate	4	4						
Amyl Alcohol	1	2	1	2	4	4	4	4
Amyl Chloride	4	4	4	4	4	4		
Aniline	2	3	1	2			4	4
Aniline Chlorohydrate	4	4					4	4
Aniline Hydrochloride	4	4					4	4
Animal Gelatin	1							
Animal Oils	1	1	1	1				
Ant Oil	4	4						
Antifreeze	1	1						
Antimony Chloride	1							
Antimony Salts	1							





# CHEMICAL COMPATIBILITY PLASTIC

MATERIAL CONVEYED	HOSE CONSTRUCTION WITH TEMPERATURE							
	PVC (F°)		TPR (F°)		TPE (F°)		POLYURETHANE (F°)	
	68	104	68	104	68	104	68	104
Antimony Trichloride	1	1					1	1
Apple Sauce/Juice	1	1						
Aqua Ammonia	4	4						
Aqua Regia	3	4	2	3			4	4
Argon, Compressed	4	4						
Aromatic Hydrocarbons	3	3	1	1				
Arsenic Acid 80%	1	2	1	1	4	4	4	4
Arsenic Trichloride	1	1					1	1
Arsenic Trioxide	1							
Arylsulfonic Acid	3	4					4	4
Askarel (Transformer Oil)	4	4						
Asphalt	4	4						
ASTM Fuel Oil # 1	1	1	1	1	2	2	1	1
ASTM Oil No. 2	4	4						
ASTM Fuel Oil # 3	2	3	1	1	2	2	1	1
ASTM Fuel A	2	2	1	1	2	2	1	1
ASTM Fuel B	4	4	1	1	2	3	2	3
ASTM Fuel C	4	4					2	3
Baby Food	1	1						
Baltic Types 100, 150, 200, 300, 500	2							
Barium Carbonate	1	1	1	1	1	1	1	1
Barium Chloride	1	1	1	1	1	1	1	1
Barium Hydroxide	1	1					2	3
Barium Sulfate	1	1	1	1	1	1	1	1
Barium Sulfide	1	1	1	1	1	1	1	1
Barley	1	4						
Basic Copper Arsenate	1							
Beer	1	1						
Beet Sugar - liquor	1	1						
Bellows 80-20 Hydraulic Oil	2							
Benzaldehyde	4	4						
Benzene	4	4						
Benzidine	4	4						
Benzoic Acid	2	3	1	2	4	4	4	4
Benzoic Aldehyde	4	4						
Benzol	4	4	2	3	3	4	3	4
Benzotrichloride	4	4						
Benzyl Alcohol	1							
Benzyl Chloride	4	4						
Berries	1	1						
Bismuth Carbonate	1	1					1	1
Black Liquor	1	1	1	1				
Blast Furnace Gas	4	4						
Bleach 12.5% Active CL	2	3	1	2	3	4	3	4
Borax	1	2	1	1			1	1
Bordeaux Mixture	1	1	1	1				
Boric Acid	1	1	1	1			4	4
Boric Oxide	1							
Boron Trifluoride	1	1					1	1
Brake Fluid (Petroleum Base)	2							
Brake Fluid (Synthetic Base)	2							
Brine	1	1	1	1	3	4	2	3
Bromic Acid	1	2	1	2	3	4	4	4
Bromine - Liquid	4	4	3	4	4	4	4	4
Bromine - Water	4	4	3	4	4	4	4	4
Bromobenzene	4	4						
Bromochloromethane	4	4						
Bromotoluene	4	4						
Bunker Oil	4	4						
Butadiene	3	4						
Butane	1	1	1	1	1	1	1	1
Butanol - Primary	4	4					3	4
Butanol - Secondary	4	4					3	4
Butter	2	3						
Butyl Acetate	1							

\* RAGCO supports the autonomy of its locations to select the best products to service their markets. Subtle variations of these specifications may exist. Contact your RAGCO affiliate for confirmation.



# CHEMICAL COMPATIBILITY PLASTIC

MATERIAL CONVEYED	HOSE CONSTRUCTION WITH TEMPERATURE							
	PVC (F°)		TPR (F°)		TPE (F°)		POLYURETHANE (F°)	
	68	104	68	104	68	104	68	104
Butyl Alcohol	1	2	1	2	1	2	3	4
Butyl Cellosolve	4	4	3	4				
Butyl Mercaptan	4	4						
Butyl Phenol	3	4	2	3				
Butyl Stearate	1							
Butylene	1	2	1	1	1	1	1	1
Butyric Acid 20%	3	4	2	3	3	4	3	4
Butynedial	4	4					4	4
Cake Alum Solution	1							
Calcium Arsenate	1							
Calcium Bisulfate	1	1	1	1	1	1		
Calcium Bisulfite	2							
Calcium Bisulfite	1	1					1	1
Calcium Carbonate	1	1	1	1	1	1	1	1
Calcium Chlorate	1	1	1	1	2	3	2	3
Calcium Chloride	1	1	1	1	3	4	3	4
Calcium Hydrosulfide	2							
Calcium Hydroxide	1	1	1	1	2	3	2	3
Calcium Hypochlorite	1	1	1	1	4	4	4	4
Calcium Metasilicate	1							
Calcium Nitrate	1	1	1	1	1	1	1	1
Calcium Silicate	1							
Calcium Sulfate	1	1	1	1	1	1	1	1
Calcium Sulfide	2							
Cane Sugar Liquors								
Carbolic Acid	4	4						
Carbon Bisulfide	1	1						
Carbon Dioxide	1	1						
Carbon Disulfide	4	4						
Carbon Monoxide	1	1	1	1	1	1	1	1
Carbon Tetrachloride	4	4	2	3	3	4	3	4
Carbolic Acid	4	4						
Carbonic Acid	1	1	1	1	4	4	4	4
Carrots	1	1	1	1	4	4		
Casein	1	2					1	1
Castor Oil	1	1	1	1	1	1	1	1
Catsup	1	2						
Caustic Potash	1	1	1	1	3	4	3	4
Caustic Soda	1	1	1	1	3	4	3	4
Cellosolve	3	4	2	3	2	3	2	3
Cellulose Acetate	1							
Cellulose Butyl	1							
Cheese	1	2						
Cherries	1	1						
China-Wood Oil	2							
Chlordane	2							
Chloracetic Acid	1	4					4	4
Chloral Hydrate	1	1					2	3
Chloric Acid 20%	1	1					4	4
Chlorinated Hydrocarbons	1	1					4	4
Chlorinated Solvents	4	4						
Chlorine Gas - dry	1	1	1	1	4	4	4	4
Chlorine Gas - moist	3	4	2	3	3	4	4	4
Chlorine Trifluoride	4	4						
Chloroacetyl Chloride	1							
Chlorobenzene	4	4						
Chlorobromomethane	4	4						
Chloroethane	4	4						
Chloroform	4	4						
Chloropentane	4	4						
Chloropicrin Mixture	4	4						
Chlorotoluene	4	4						
Chlorox	1							
Chlorsulfonic Acid	3	4					4	4





# CHEMICAL COMPATIBILITY PLASTIC

MATERIAL CONVEYED	HOSE CONSTRUCTION WITH TEMPERATURE							
	PVC (F°)		TPR (F°)		TPE (F°)		POLYURETHANE (F°)	
	68	104	68	104	68	104	68	104
Chocolate	2	3						
Chocolate Syrup	1							
Chromic Chloride	1							
Chrome Alum	1	1	1	1	1	1	1	1
Chromic Acid 25%	2	3	1	2	4	4	4	4
Chromic Acid 50%	2	3	1	2	4	4	4	4
Chromium Trioxide	4	4						
Cider	2							
Citgo FR Fuels	2							
Coal Gas	1							
Coal Tar	4	4	3	3			4	4
Coconut Oil	3	4	1	1	1	1	1	1
Cola Beverage	1	1						
Copper Chloride	1	2	1	1	1	1	1	1
Copper Cyanide	1	1						
Copper Flouride 2%	1	1					1	1
Copper Nitrate	1	2	1	1	1	1	1	1
Copper Sulphate	1	2					1	1
Core Oils	1	1					1	1
Corn Oils	1	2						
Cottonseed Oil	2	3					1	1
Creosole	4	4	3	4	3	4		
Creosote	4	4	3	4				
Cresylic Acid 50%	4	4					4	4
Crude Oil Sour	1	1	1	1	1	1	1	1
Crude Oil Sweet	1	1	1	1	1	1	1	1
Crude Wax	1							
Cupric Chloride	1							
Cupric Cyanide	1							
Cupric Nitrate	1							
Cupric Sulfate	1							
Cyanide, Copper	1							
Cyanide, Silver	1							
Cyanide Sodium	1							
Cyclohexane	4	4						
Cyclohexanol	4	4					3	4
Cyclohexanone	4	4					4	4
Cymene	4	4						
Decanol	4	4						
Deicing Fluid	1	1						
Deminerized Water	1	1	1	1	3	4	2	4
Denatured Alcohol	1							
Detergents, synthetic	1	2	1	1				
Developers, photographic	1	1	1	1				
Dextrin	1							
Dextron	2							
Dextrose	1	2	1	1	1	1	1	1
Diacetone	4	4						
Diacetone Alcohol	4	4						
Diammonium Phosphate	1							
Diazinon	2							
Diazo Salts	1	1						
Dibutyl Phthalate	1							
Dibutylamine	4	4						
Dichlorobenzene	4	4						
Dichlorobenzyl Chloride	4	4						
Dichloroethane	4	4						
Dichloroethylene	4	4						
Dichloromethane	4	4						
Diesel Oils	3	4	1	2				
Diethanolamine	2							
Diethyl Ether	2							
Diethyl Ketone	4	4						
Diethyl Oxalate	4	4						

\* RAGCO supports the autonomy of its locations to select the best products to service their markets. Subtle variations of these specifications may exist. Contact your RAGCO affiliate for confirmation.



# CHEMICAL COMPATIBILITY PLASTIC

MATERIAL CONVEYED	HOSE CONSTRUCTION WITH TEMPERATURE							
	PVC (F°)		TPR (F°)		TPE (F°)		POLYURETHANE (F°)	
	68	104	68	104	68	104	68	104
Diethylene Dioxide	2							
Diethylene Ether	4	4						
Diethylene Glycol	1							
Diglycolic Acid	1	2						
Dihydroxyethyl Ether	1							
Dimethylamine	4	4					4	4
Dimethylbenzene	4	4						
Dimethylcarbonal	2							
Dimethylketone	4	4						
Dioctyl Phthalate	4	4						
Dioctyl Phosphite	4	4						
Dioxane	4	4						
Disodium Phosphate	1	1	1	1	1	1	1	1
Distilled Water	1	1	1	1	3	4	2	4
DMB ( Dimethylbenzene )	4	4						
Duro Oils	2							
EDB (Ethylene Dibromide)	4	4						
Eggs	1	1						
Emulsions, photographic	1	1						
Enamels	2							
Essential Oils	2							
Ethanolamine	2							
Ethers	4	4					2	3
Ethyl Acetate	4	4						
Ethyl Acrylate	4	4						
Ethyl Alcohol	2	3						
Ethyl Alcohol 50-98%	3	4						
Ethyl Bromide	4	4						
Ethyl Chloride	4	4	4	4	4	4	4	4
Ethyl Ether	4	4					2	3
Ethyl Ether Acetate	1							
Ethyl Mercaptan	4	4						
Ethyl Methyl Ketone	4	4						
Ethylbutanol	1							
Ethylbutyl Alcohol	1							
Ethylene Bromide	1	4	1	3	4	4	4	4
Ethylene Chlorohydrin	4	4						
Ethylene Dibromide	4	4						
Ethylene Dichloride	4	4					4	4
Ethylene Glycol	1	1	1	1	2	3	2	3
Ethylene Oxide	4	4					4	4
Ethylhexanol	1							
Ethylhexyl Acrylate	4	4						
Ethylhexyl Alcohol	1							
Fatty Acid	2							
Fatty Alcohol, Blend	1							
Ferric Chloride	1	1	1	1	2	3	2	3
Ferric Nitrate	1	1	1	1	1	1	1	1
Ferric Sulphate	1	1	1	1	1	1	1	1
Ferrous Chloride	1	1					1	1
Ferrous Nitrate	2							
Ferrous Sulfate Solution	1							
Fertilizer	2							
Figs	1	1						
Fish Solubles	1	1						
Fixing Solutions, photographic	1	2						
Flour	1	4						
Flourobic Acid	1	1	1	1	1	1		
Fluorine	4	4					4	4
Fluosilic Acid	4	4						
Foric Acid	1	3					4	4
Formaldehyde Solution (to 50%)	1							
Formalin	1							
Formic Acid 3%	1	2						
Formic Acid 10%	1	2					4	4





# CHEMICAL COMPATIBILITY PLASTIC

MATERIAL CONVEYED	HOSE CONSTRUCTION WITH TEMPERATURE							
	PVC (F°)		TPR (F°)		TPE (F°)		POLYURETHANE (F°)	
	68	104	68	104	68	104	68	104
Formic Acid 25%	1	2					4	4
Formic Acid 50%	3	4					4	4
Freon-12	1	2	1	1	1	1	1	1
Fructose	1	1	1	1	1	1	1	1
Fruit Pulp and Juices	1	1					1	1
Fuel Oil	2	3	1	1	1	2	1	1
Fumaric Acid	4	4						
Furan	4	4						
Furfural	4	4					4	4
Furfuryl Alcohol	1	3						
Fusel Oil	1							
Gallic Acid Solution	4	4						
Gasohol	4	4						
Gas - cook oven	2	2	1	2	2	2	2	2
Gas - natural (dry)	1	1	1	1	1	1	1	1
Gas- natural (wet)	1	1	1	1	1	1	1	1
Gasoline	4	4						
Gasoline - refined	3	4	1	1	2	3		
Gasoline, Unleaded	4	4						
Gasoline, White	4	4						
Gelatin	1	1	1	1	1	1	1	1
Gin	1	2						
Ginger Ale	1	1						
Glacial Acetic Acid	4	4						
Glucose	1	1	1	1	1	1	1	1
Glue	1							
Glycerine	1	1	1	1	1	1		
Glycerol	1	1						
Glycol	1	1	1	1	2	2	1	1
Glycolic Acid 30%	1	1					4	4
Grape Juice	1	1						
Grapefruit Juice	1	1						
Grease	1							
Green Liquor (paper)	1	1						
Heptachlor	4	4						
Heptane	3	4	1	2	1		1	
Heptanol	1							
Hexane	3	4						
Honey	1	1						
HPO (Sodium Thiosulfate)	1							
Hydraulic Fluid	1							
Hydraulic Fluid HF-18, HF-20	2							
Hydrazine	4	4						
Hydro-Drive Oil (houghton)	2							
Hydrobromic Acid	4	4						
Hydrochloric Acid 10%	1	1	1	1	4	4	4	4
Hydrochloric Acid 48%	3	4					4	4
Hydrocyanic Acid	4	4						
Hydrofluoric Acid 4%	2	3					4	4
Hydrofluoric Acid 10%	3	3					4	4
Hydrofluoric Acid 48%	3	4					4	4
Hydrofluoric Acid 60%	3	4					4	4
Hydrofluosilicic Acid	4	4					4	4
Hydrogen	1	2	1	1	1	1	1	1
Hydrogen Bromide (Dry) (liquid)							1	1
Hydrogen Cyanide	1	1					4	4
Hydrogen Peroxide	4	4						
Hydrogen Peroxide 12%	1	2	1	1	2	3		
Hydrogen Peroxide 50%	1	3	1	2	3	4	2	3
Hydrogen Peroxide 90%	4	4	3	4	4	4	4	4
Hydrogen Phosphide	1	3						
Hydrogen Sulfide - Aqueous Solution	1	1						
Hydrogen Sulfide - Dry	1	1						
Hydrolube (water glycol)	1	1						
Hydrolubric Oil	2							

\* RAGCO supports the autonomy of its locations to select the best products to service their markets. Subtle variations of these specifications may exist. Contact your RAGCO affiliate for confirmation.



# CHEMICAL COMPATIBILITY PLASTIC

MATERIAL CONVEYED	HOSE CONSTRUCTION WITH TEMPERATURE							
	PVC (F°)		TPR (F°)		TPE (F°)		POLYURETHANE (F°)	
	68	104	68	104	68	104	68	104
Hydroquinone Solution	2							
Hydroxylamine Sulfate	1	1						
Hypochlorous Acid	1	1					3	4
Iodine	4	4						
Iron Acetate Liquor	1							
Iron Salts	1							
Iron Sulfate Solution	1							
Isobutanol	2							
Isobutyl Alcohol	2							
Isooctane	4	4						
Isopropanol	2							
Isopropyl Acetate	4	4						
Isopropyl Alcohol	1	2	1	1	3	4		
Isopropyl Ether	4	4						
JP 3, 4, 5	4	4	2	3	3	3	2	3
Jelly	1	1						
Jet Fuel - All Types	4	4						
Karo Syrup	1	1						
Kerosene	4	4	1	1	1	1	1	2
Ketones	4	4						
Kraft Liquor (paper)	1	1						
Lacquer Thinner	3	4	2	2	3	3	2	
Lactic Acid 28%	1	1					4	4
Lard	2	3						
Lard Oil	1	2					1	2
Latex Paint	1							
Lauric Acid	1	1	1	1	3	4	3	4
Lauryl Chlorite	1	1					1	2
Lauryl Sulfate	1	1						
Lead Acetate	1	1	1	1	1	1	1	1
Lead Nitrate Solution	1							
Lead, Tetraethyl	1							
Lemon Juice	1	2						
Ligroin	4	4						
Lime. Chloronated	2							
Lime, sulfur	1	1						
Linoleic Acid	1							
Linseed Oil	1	1	1	1	1	1	1	1
Liquid Soap	2							
Liquors	1	2						
Lubricating Oils	4	4	1	1	1	1	1	1
Machine Oil under 135°F	2							
Magnesium Carbonate	1	1	1	1	1	1	1	1
Magnesium Hydroxide	1	1	1	1	3	4	2	3
Magnesium Nitrate	1	1					1	1
Magnesium Sulfate Solution	1							
Malathion	1							
Maleic Acid Solution	4	4						
Manganese Salts	1							
Manganese Sulfate Solution	1							
Mayonnaise	1	1						
MBK (Methyl Butyl Ketone)	4	4						
MEA (Ethanolamine)	2							
MEK (Ethyl Methyl Ketone)	4	4						
Mercuric Chloride	2	2	1	1	2	3	2	3
Mercuric Chloride Solution	2							
Mercuric Cyanide	2	2						
Mercuric Nitrate	2	2					2	2
Mercury	2	2						
Mesitylene	4	4						
Mesityl Oxide	4	4						
Mesitylene	4	4						
Methanol	4	4	4	4	4	4	4	4
Methyl Acetate	4	4						
Methyl Acetone	1							





# CHEMICAL COMPATIBILITY PLASTIC

MATERIAL CONVEYED	HOSE CONSTRUCTION WITH TEMPERATURE							
	PVC (F°)		TPR (F°)		TPE (F°)		POLYURETHANE (F°)	
	68	104	68	104	68	104	68	104
Methyl Alcohol	3	4	2	3	3	4	4	4
Methyl Bromide	4	4						
Methyl Butanathiol	4	4						
Methyl Butanol	1							
Methyl Chloride	4	4					4	4
Methyl Chloroform	4	4						
Methyl Cyanise	1							
Methyl Ethyl Ketone	4	4	2	3	3	4		
Methyl Isobutenyl Ketone	4	4						
Methyl Isobutyl Ketone	4	4						
Methyl Isopropyl Ketone	4	4						
Methyl Methacrylate	1							
Methyl Methacrylate Monomer	4	4						
Methyl Propyl Ketone	4	4						
Methyl Slaicylate	1							
Methyl Sulfate	1							
Methylamine	4	4						
Methylaniine	4	4						
Methylene Bromide	4	4						
Methylene Chloride	4	4						
Methylene Dichloride	4	4						
Milk	1	1					1	1
Mineral Oils	1	2	1	1	1	1	1	1
Molasses	1	1	1	1	1	1	1	1
Monochlorobenzene	4	4						
Monomethylamine	4	4						
Monosodium Phosphate	1							
Motor Oil	3							
Muriatic Acid	4	4						
N-Octane	4	4						
Naphthenic Acid	1							
Naptha	4	4	1	1				
Napthalene	3	4	1	1				
Nickel Chloride Solution	1	1					1	1
Nickel Nitrate Solution	2						1	1
Nickel Plating Solution	4	4						
Nickel Salts	2							
Nickel Sulfate Solution	1							
Nicotine	1	1					1	1
Nicotine Acids	1	2	1	1	3	4	3	4
Nicotine Salts	1							
Niter Cake	1							
Nitric Acid 10%	1	2		1	4	4	4	4
Nitric Acid 40%	2	3	1	1	4	4	4	4
Nitric Acid 60%	3	4	2	3	4	4	4	4
Nitric Acid 68%	3	4	2	3	4	4	4	4
Nitric Acid 70%	4	4	3	3	4	4	4	4
Nitrobenzene	4	4					4	4
Nitrogen	1							
Nitrogen Oxide	4	4						
Nitromethane	4	4						
Nitrous Acid (up to 10%)	1							
Nitrous Oxide	1	1					1	1
Oats	1	4						
Octadecanoic Acid	1							
Octanol	2							
Octyl Alcohol	2							
Oil of Turpentine	1							
Oils, Animal	2							
Oils, Mineral	4	4						
Oils, Petroleum	1	2	1	1	1	1	1	1
Oleic Acid	2	3	1	1	4	4	4	4
Oleum	4	4	4	4	4	4	4	4
Olive Oil	2	2						
Ortho-Dichlorobenzene	4	4						

\* RAGCO supports the autonomy of its locations to select the best products to service their markets. Subtle variations of these specifications may exist. Contact your RAGCO affiliate for confirmation.



# CHEMICAL COMPATIBILITY PLASTIC

MATERIAL CONVEYED	HOSE CONSTRUCTION WITH TEMPERATURE							
	PVC (F°)		TPR (F°)		TPE (F°)		POLYURETHANE (F°)	
	68	104	68	104	68	104	68	104
Ortho-xylene	4	4						
Oxalic Acid	4	4						
Oxygen	1	1					1	1
Ozone	3	4						
Paint	1							
Para formaldehyde	1	2						
Paraffin	1	2						
Palmitic Acid 10%	1	2					4	4
Palmitic Acid 70%	3	4					4	4
Peaches	1	1						
Peanut Butter	1	2						
Peanut Oil	2							
Peas	1	1						
Pentachlorophenol in Oil	4	4						
Pentane	3	4						
Pentanone	4	4						
Pentasol	2							
Perchloric acid	4	4						
Perchloroethylene	4	4						
Petrol	4	4						
Petroleum Ether	3	3	1	1				
Petroleum Naptha	4	4						
Petroleum Oils (Refined)	1							
Petroleum Oils (Sour)	2							
Phenol	4	4						
Phenol Acid	4	4						
Phenyl Chloride	4	4						
Phenolhydrazine	4	4						
Phenolhydrazine Hydrochloride	3	4						
Phosgene (gas)	1	2						
Phosgene (liquid)	4	4						
Phosphorous (yellow)	2	3						
Phosphorous Pentoxide	4	4						
Phosphorous Trichloride	1	1					1	1
Phosphorous Trichloride	1	1					1	1
Photographic Chemicals	1	1					1	2
Photographic Fixing Solutions	1							
Picric Acid	4	4	4	4	4	4	4	4
Pinene	4	4						
Pitch	2	3	1	1				
Plating Solutions	1	2					1	1
Polyethylene Glycol	2							
Potash	1							
Potassium Acetate	1							
Potassium Acid Sulfate	1	1					1	1
Potassium Antimonate	1	1					1	1
Potassium Bicarbonate	1	1	1	1	1	1	1	1
Potassium Bichromate	1	1					1	1
Potassium Bisulfate	1							
Potassium Bisulfite	1	1					1	1
Potassium Borate 1%	1	1					1	1
Potassium Bisulfate	1							
Potassium Bromate 10%	1	1	1	1	1	1	1	1
Potassium Bromide	1	1	1	1	1	1	1	1
Potassium Carbonate	1							
Potassium Chlorate	1							
Potassium Chloride	1	1	1	1	1	2	1	2
Potassium Chromate	1						2	2
Potassium Cuprocyanide	1							
Potassium Cyanide	1	1	1	1	1	1	1	1
Potassium Dichromate	1	1					2	2
Potassium Ferrocyanide	1	1					1	1
Potassium Fluoride	1	1	1	1	1	2		
Potassium Hydrate	2							
Potassium Hydroxide	1	1						





# CHEMICAL COMPATIBILITY PLASTIC

MATERIAL CONVEYED	HOSE CONSTRUCTION WITH TEMPERATURE							
	PVC (F°)		TPR (F°)		TPE (F°)		POLYURETHANE (F°)	
	68	104	68	104	68	104	68	104
Potassium Hypochlorite	2	3					4	4
Potassium Iodide	1							
Potassium Nitrate	1	1	1	1	1	1	1	1
Potassium Perborate	1	1	1	1	1	1	1	1
Potassium Perchlorite	1	1					2	3
Potassium Permanganate	4	4						
Potassium Persulfate	1							
Potassium Sulfate	1							
Potassium Sulfide	1	1	1	1	1	1	1	1
Potassium Sulfite	2							
Potassium Thiosulfate	1							
Potatoes	1	1						
Propane	1	1	1	1	1	1	1	1
Propargyl Alcohol	1	1						
Propyl Alcohol	1	2	1	1	2	3	2	3
Propylene Dichloride	4	4					4	4
Propylene Glycol	1						4	4
Prune Juice	1	1						
Puropale RX Oils	2							
Pyrene	4	4						
Pyrethrum	2							
Pyridine	4	4						
Pyrogard C, D	2							
Red Oil	2							
Regal Oils R&O	2							
Richfield A Weed Killer	1	2						
Rubilene Oils	2							
Salicylic Acid	1							
Salt Water	1	1	1	1	2	3	2	4
Sauerkraut	2							
Selenic Acid	1	2					4	4
Sewage	2							
Shortening	2	3						
Silicic Acid	1	1					4	4
Silicone Greases	2							
Silicone Oils	2							
Silver Cyanide	1	1					1	1
Silver Nitrate	1	1	1	1	1	1	1	1
Silver Plating Solution	1	2	1	1	1	1	1	1
Skydrol 500A & 7000	4	4						
Soap	1	1	1	1	2	3	2	4
Soda Ash	1							
Soda Water	1	1						
Sodium Acetate	1	1					1	1
Sodium Alminate Solution	2							
Sodium Arsenite	1	1					1	1
Sodium Benzoate	1	2	1	1	1	1	1	1
Sodium Bicarbonate	1	1	1	1	1	1	1	1
Sodium Bichromate Solution	2							
Sodium Bisulfite	1							
Sodium Borate	1							
Sodium Bromide	1	1	1	1	1	2	1	2
Sodium Carbonate (soda ash)	1	1	1	1	1	2	1	1
Sodium Chlorate	2	3	1	2	3	3	2	2
Sodium Chloride	1	1	1	1	1	2	1	2
Sodium Chlorite Solution	2							
Sodium Chromate	2							
Sodium Cyanide	1	1	1	1	1	1	1	1
Sodium Dichromate	1	2	1	2	1	2	1	2
Sodium Ferricyanide	1	1					1	1
Sodium Ferrocyanide	1	1					1	1
Sodium Fluoride (70%)	1	1					1	2
Sodium Hydrate	2							
Sodium Hydrochlorite	2							
Sodium Hydrosulfide	1							

\* RAGCO supports the autonomy of its locations to select the best products to service their markets. Subtle variations of these specifications may exist. Contact your RAGCO affiliate for confirmation.





# CHEMICAL COMPATIBILITY PLASTIC

MATERIAL CONVEYED	HOSE CONSTRUCTION WITH TEMPERATURE							
	PVC (F°)		TPR (F°)		TPE (F°)		POLYURETHANE (F°)	
	68	104	68	104	68	104	68	104
Sodium Hydrosulfite	2							
Sodium Hydroxide 10%	1	1	1	1	3	4	3	4
Sodium Hydroxide 35%	1	2	1	1	4	4	4	4
Sodium Hydroxide 50%	1	3	1	2				
Sodium Hypochlorite (20%)	1	1					4	4
Sodium Hyposulfate	1							
Sodium Metaphosphate	1							
Sodium Nitrate	1	1					1	1
Sodium Nitrite	1	1					1	1
Sodium Peroxide	1							
Sodium Phosphate	1							
Sodium Phosphate Acid	2	2	1	2	4	4		
Sodium Silicate	1							
Sodium Sulfate	1							
Sodium Sulfhydrate	2							
Sodium Sulfide	1	1					1	1
Sodium Sulfite	1	1					1	1
Sodium Sulphrydate	2							
Sodium Thiosulfat	1	1					1	2
Solnus Oils	1							
Sour Crude Oil	4	4						
Soya Beans	1	4						
Soya Oil	1	3						
Soybean Oil	1	1						
Spent Acid	4	4						
Spinach	1	1						
Squash	1	1						
Stannic Chloride	2							
Stannis Chloride	1	1	1	1	1	2	1	2
Starch	1							
Starch Gum	1							
Stearic Acid	1							
Stoddard Solvent	2							
Straight Synthetic Oils	2							
Styrene	4	4						
Sugar - all forms	1	1						
Sulfamic Acid	4	4						
Sulfate Liquors under 150° F	1							
Sulfur	2	2						
Sulfur Chloride	2							
Sulfur Dioxide (dry)	1							
Sulfur Dioxide (liquid)	4	4						
Sulfur Hexafluoride (Gas)	2							
Sulfur Trioxide	1							
Sulfuric Acid 10%	1	2	1	1	3	4	3	4
Sulfuric Acid 70%	1	2	1	1	4	4	4	4
Sulfuric Acid 95%	3	3	1	2	4	4	4	4
Sulfurous Acid	2	3	1	2	4	4	4	4
Sulphur Dioxide Gas - dry	1	1						
Sulfur Dioxide Gas - wet	4	4						
Sulfur Dioxide - Liquid	3	4						
Sun R&O Oils	2							
Suntac HP Oils	2							
Suntac WR Oils	2							
Sunvis Oils 700, 800, 900	2							
Synthetic Oil (Citgo)	2							
Tall Oil	4	4						
Tallow	2							
Tannic Acid	1	1	1	1	3	4	3	4
Tanning Liquors	1	1						
Tar Oil	2							
Tartaric Acid	1	2	1	1	2	3	3	4
TEA (Triethanolamine)	2	3						
Tellus Oils	2							





# CHEMICAL COMPATIBILITY PLASTIC

MATERIAL CONVEYED	HOSE CONSTRUCTION WITH TEMPERATURE							
	PVC (F°)		TPR (F°)		TPE (F°)		POLYURETHANE (F°)	
	68	104	68	104	68	104	68	104
Tenol Oils	2							
Terpineol	2							
Tetrachloroethane	4	4						
Tetraethyl Lead	2	3						
Tetrahydrofuran	4	4						
Tetrahydroxydicyclopentadiene	4	4						
THF (Tetrahydrofuran)	4	4						
Thionyl Chloride	4	4					4	4
Tin Chloride	1	1	1	1	1	1		
Titanium Tetrachloride	1	4					3	4
Toluene	4	4	2	2	3	4		
Toluol	4	4						
Tomatoes	1	1						
Tributyl Phosphate	4	4						
Trichloroethylene	4	4					3	4
Trichloroethane	4	4						
Tricresyl Phosphate	4	4					4	4
Triethanolamine	3	4						
Triethylamine	2	3						
Trihydroxybenzoic Acid	4	4						
Trimethylbenzene	4	4						
Trimethyl Propane	3	4						
Trinitrophenol	1							
Trisodium Phosphate	1	1	1	1	1	1	1	1
Tung Oil	2							
Turpentine	3	4	1	1	2	3	1	2
Ucon Hydrolube Types 150CP, 200CP	2							
Ucon Hydrolube Types 275CP,300CP, 550CP	2							
Ucon M1	2							
Union Hydraulic Tractor Fluid	2							
Urea	1	2	1	1	1	1	1	1
Urine	1	1	1	1	1	1	1	1
Varnish	4	4	1	1	1	2	1	2
Vegetable Oils	2	3						
Versilube F-50, F-44	2							
Vinegar	1	2					2	3
Vinyl Acetate	4	4					4	4
Vinyl Chloride	4	4						
Vinyl Trichloride	4	4						
Vitrea Oils	2							
Vodka	1	2						
Water Acid - mine water	1	1	1	1	3	4	2	4
Water in Oil Emulsions	1							
Water - distilled	1	1	1	1	3	4	2	4
Water - fresh	1	1	1	1	3	4	2	4
Water - salt	1	1	1	1	3	4	2	4
Whiskey	1	2						
White Gasoline	1	1	1	1	1	2	1	2
White Liquor (paper)	1	1						
Wines	1	2						
Wood Oil	1							
Xylene	4	4	1	1	2	3	2	3
Xylol	4	4	1	1	2	3	2	3
Yeast	1	2						
Yogurt	1	2						
Zeric	2							
Zinc Acetate	1							
Zinc Chloride Solutions	1							
Zinc Chromate	1	1	1	1	1	1	1	1
Zinc Cyanide	1	1	1	1	1	1	1	1
Zinc Hydrate	1							
Zinc Nitrate	1	1	1	1	1		1	1
Zinc Sulfate	1	1	1	1	1	1	1	1

\* RAGCO supports the autonomy of its locations to select the best products to service their markets. Subtle variations of these specifications may exist. Contact your RAGCO affiliate for confirmation.



# METRIC CONVERSIONS

INCHES		METRIC
FRACTIONAL	DECIMAL	MM
	0.0039	0.1
	0.0079	0.2
	0.0118	0.3
1/64	0.0156	0.3969
	0.0157	0.4
	0.0197	0.5
	0.0236	0.6
	0.0276	0.7
3/64	0.0313	0.7938
	0.0315	0.8
	0.0354	0.9
	0.0394	1
	0.0433	1.1
	0.0469	1.1906
	0.0472	1.2
	0.0512	1.3
	0.0551	1.4
	0.0591	1.5
1/16	0.0625	1.5875
	0.063	1.6
	0.0669	1.7
	0.0709	1.8
	0.0748	1.9
5/64	0.0781	1.9844
	0.0787	2
	0.0827	2.1
	0.0866	2.2
	0.0906	2.3
3/32	0.0938	2.3813
	0.0945	2.4
	0.0984	2.5
7/64	0.1094	2.7781
	0.1181	3
1/8	0.125	3.175
	0.1378	3.5
9/64	0.1406	3.5719
5/32	0.1563	3.9688
	0.1575	4
10/64	0.1719	4.3656
	0.1772	4.5
3/16	0.1875	4.7625

INCHES		METRIC
FRACTIONAL	DECIMAL	MM
.	0.1969	5
13/64	0.2031	5.1594
.	0.2165	5.5
7/32	0.2188	5.5563
15/64	0.2344	5.9531
.	0.2362	6
1/4	0.25	6.35
.	0.2559	6.5
17/64	0.2656	6.7469
.	0.2756	7
9/32	0.2813	7.1438
.	0.2953	7.5
19/64	0.2969	7.5406
5/16	0.3125	7.9375
.	0.315	8
21/64	0.3281	8.3344
.	0.3346	8.5
9/32	0.3438	8.7313
.	0.3543	9
23/64	0.3594	9.1281
.	0.374	9.5
3/8	0.375	9.525
25/64	0.3906	9.9219
.	0.3937	10
13/32	0.4063	10.3188
.	0.4134	10.5
27/64	0.4219	10.7156
.	0.4331	11
7/16	0.4375	11.1125
.	0.4528	11.5
29/64	0.4531	11.5094
15/32	0.4688	11.9063
.	0.4724	12
31/64	0.4844	12.3031
.	0.4921	12.5
1/2	0.5	12.7
.	0.5118	13
33/64	0.5156	13.0969
17/32	0.5313	13.4938
.	0.5315	13.5
35/64	0.5469	13.8906

INCHES		METRIC
FRACTIONAL	DECIMAL	MM
.	0.5512	14
9/16	0.5625	14.2875
.	0.5709	14.5
37/64	0.5781	14.6844
.	0.5906	15
19/32	0.5938	15.0813
39/64	0.6094	15.4781
.	0.6102	15.5
5/8	0.625	15.875
.	0.6299	16
41/64	0.6406	16.2719
.	0.6496	16.5
21/32	0.6563	16.6688
.	0.6693	17
43/64	0.6719	17.0656
11/16	0.6875	17.4625
.	0.689	17.5
45/64	0.7031	17.8594
.	0.7087	18
23/32	0.7188	18.2563
.	0.7283	18.5
47/64	0.7344	18.6531
.	0.748	19
3/4	0.75	19.05
49/64	0.7656	19.4469
.	0.7677	19.5
25/32	0.7813	19.8438
.	0.7874	20
51/64	0.7969	20.2406
.	0.8071	20.5
13/16	0.8125	20.6375
.	0.8268	21
53/64	0.8281	21.0344
27/32	0.8438	21.4313
.	0.8465	21.5
55/64	0.8594	21.8281
.	0.8661	22
7/8	0.875	22.225
.	0.8858	22.5
57/64	0.8906	22.6219
.	0.9055	23





# METRIC CONVERSIONS

INCHES		METRIC
FRACTIONAL	DECIMAL	MM
29/32	0.9063	23.0188
59/64	0.9219	23.4156
.	0.9252	23.5
15/16	0.9375	23.8125
.	0.9449	24
61/64	0.9531	24.2094
.	0.9646	24.5
31/32	0.9688	24.6063
.	0.9843	25
63/64	0.9844	25.0031
1	1	25.4
.	1.0039	25.5
.	1.0236	26
.	1.0433	26.5
.	1.063	27
.	1.0827	27.5
.	1.1024	28
.	1.122	28.5
.	1.1417	29
.	1.1614	29.5
.	1.1811	30
.	1.2205	31
1 1/4	1.25	31.75
.	1.2598	32
.	1.2992	33
.	1.3386	34
.	1.378	35
.	1.4173	36
.	1.4567	37
.	1.4961	38
1 1/2	1.5	38.1
.	1.5354	39
.	1.5748	40
.	1.6142	41
.	1.6535	42
.	1.6929	43
.	1.7323	44
1 3/4	1.75	44.45
.	1.7717	45
.	1.811	46
.	1.8504	47

INCHES		METRIC
FRACTIONAL	DECIMAL	MM
.	1.8898	48
.	1.9291	49
.	1.9685	50
2	2	50.8
.	2.0079	51
.	2.0472	52
.	2.0866	53
.	2.126	54
.	2.1654	55
.	2.2047	56
.	2.2441	57
2 1/4	2.25	57.15
.	2.2835	58
.	2.3228	59
.	2.3622	60
.	2.4016	61
.	2.4409	62
.	2.4803	63
2 1/2	2.5	63.5
.	2.5197	64
.	2.5591	65
.	2.5984	66
.	2.6378	67
.	2.6772	68
.	2.7165	69
2 3/4	2.75	69.85
.	2.7559	70
.	2.7953	71
.	2.8346	72
.	2.874	73
.	2.9134	74
.	2.9528	75
.	2.9921	76
3	3	76.2
.	3.0315	77
.	3.0709	78
.	3.1102	79
.	3.1496	80
.	3.189	81
.	3.2283	82
.	3.2677	83

INCHES		METRIC
FRACTIONAL	DECIMAL	MM
.	3.3071	84
.	3.3465	85
.	3.3858	86
.	3.4252	87
.	3.4646	88
3 1/2	3.5	88.9
.	3.5039	89
.	3.5433	90
.	3.5827	91
.	3.622	92
.	3.6614	93
.	3.7008	94
.	3.7402	95
.	3.7795	96
.	3.8189	97
.	3.8583	98
.	3.8976	99
.	3.937	100
4	4	101.6
.	4.3307	110
4 1/2	4.5	114.3
.	4.7244	120
5	5	127
.	5.1181	130
.	5.5118	140
.	5.9055	150
6	6	152.4
.	6.2992	160
.	6.6929	170
.	7.0866	180
.	7.4803	190
.	7.874	200
8	8	203.2
.	9.8425	250
10	10	254
20	20	508
30	30	762
40	40	1016
60	60	1524
80	80	2032
100	100	2540

\* RAGCO supports the autonomy of its locations to select the best products to service their markets. Subtle variations of these specifications may exist. Contact your RAGCO affiliate for confirmation.







**CONTACT US TO FIND YOUR RAGCO AFFILIATE**



**Ragco, Inc., Corporate Office**  
5920 Grelot Road, Suite C-1  
Mobile, AL 36609

**PHONE** (800) 543-9265  
**FAX** (251) 342-8778

**RAGCO.COM**

